

KNB/KNC/KNND Series

Medium & High Density PCB Connectors

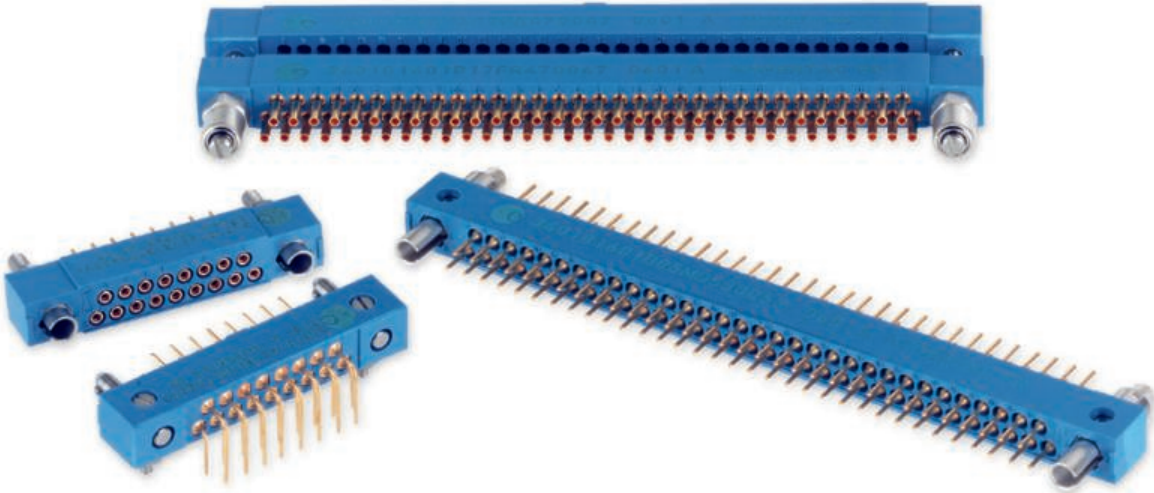

Hypertac[®] Hyperboloid Technology

Smiths Interconnect offers an extensive range of superior contact technologies suitable for standard and custom solutions. Hypertac[®] (HYPERboloid conTACT) is the original superior performing hyperboloid contact technology designed for use in all applications and in harsh and demanding environments where high reliability and safety are critical. The inherent electrical and mechanical characteristics of the Hypertac hyperboloid contact ensures unrivalled performance in terms of reliability, number of mating cycles, low contact force and minimal contact resistance. The shape of the contact sleeve is formed by hyperbolically arranged contact wires, which align themselves elastically as contact lines around the pin, providing a number of linear contact paths.

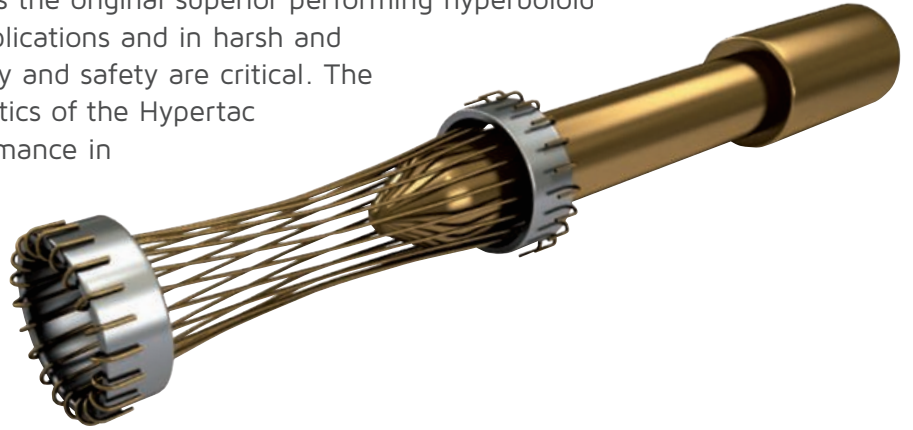

Features

Low insertion/extraction forces

The angle of the socket wires allows tight control of the pin insertion and extraction forces. The spring wires are smoothly deflected to make line contact with the pin.

Long contact life

The smooth and light wiping action minimizes wear on the contact surfaces. Contacts perform up to 100,000 insertion/extraction cycles with minimal degradation in performance.

Lower contact resistance

The design provides a far greater contact area and the wiping action of the wires insures a clean and polished contact surface. Our contact technology has about half the resistance of conventional contact designs.

Higher current ratings

The design parameters of the contact (e.g., the number, diameter and angle of the wires) may be modified for any requirement. The number of wires can be increased so the contact area is distributed over a larger surface. Thus, the high current carried by each wire because of its intimate line contact, can be multiplied many times.

Immunity to shock & vibration

The low mass and resultant low inertia of the wires enable them to follow the most abrupt or extreme excursions of the pin without loss of contact. The contact area extends 360° around the pin and is uniform over its entire length. The 3 dimensional symmetry of the Hypertac contact design guarantees electrical continuity in all circumstances.

Benefits

High density interconnect systems

Significant reductions in size and weight of sub-system designs. No additional hardware is required to overcome mating and unmating forces.

Low cost of ownership

The Hypertac contact technology will surpass most product requirements, thus eliminating the burden and cost of having to replace the connector or the entire subsystem.

Low power consumption

The lower contact resistance of our technology results in a lower voltage drop across the connector reducing the power consumption and heat generation within the system.

Maximum contact performance

The lower contact resistance of the Hypertac contact reduces heat build-up; therefore Hypertac contacts are able to handle far greater current in smaller contact assemblies without the detrimental effects of high temperature.

Reliability under harsh environments

Harsh environmental conditions require connectors that will sustain their electrical integrity even under the most demanding conditions such as shock and vibration. The Hypertac contact provides unmatched stability in demanding environments when failure is not an option.

Contents

KN Series - Medium Density PCB Connectors

KNB series (2 rows).....	2
KXB series (2 rows).....	18
KNC/KND series (3 rows)	21
Contacts.....	36
Tools and accessories.....	37

Technical Characteristics

Contact diameter	HYPERTAC® type Ø 0.60 mm rear removable
Number of contact	Up to 120
Pitch	2.54 mm between rows - 1.27 mm between quicuncial contacts
Rows	2

Materials & Platings

Contact	Brass or bronze	
Molding	Glass fiber filled diallyl - Phtalate	
Guides	Stainless steel or nickel plated brass	
	Standard	ESA
Pin body	0.25 µm gold / 1.27 µm Ni	1.27 µm gold / 1.27 µm Ni (min.)
Socket body	0.25 µm gold / 1.27 µm Ni on active area 1.27 µm Ni on non active area	0.25 µm gold / 1.27 µm Ni (min.)
Socket wires	1 µm gold / 0.20 µm Ni	1.27 µm gold / 0.20 µm Ni (min.)

Electrical

Current grade rating (at 25°C)	Standard grade: 3 A max. - ESA grade: 5 A max.
Dielectric withstanding voltage	1200 Vrms
Contact resistance	≤8 mΩ
Insulation resistance	>104 MΩ (500 Vcc)

Mechanical

Mating & unmating cycle	5000
Guiding	By two outside guides (2 guiding styles) and one central guide (3 guiding styles)
Keying	By rotating of outside polarized guides (up to 36 keying)

Environmental

Temperature range	-55° C to 125° C
Conformity	MIL C 55302, ESA/ESCC3401/016 - 3401/017, NF C-UTE C 93-424

How To Order



1 Series																																																																									
2 Pitch or type	N 1.27 mm pitch, rear removable contacts																																																																								
3 Model	B 2 rows																																																																								
4 Number of contacts	0 1 7 0 2 9 0 4 1 0 5 3 0 6 5 0 7 2 0 8 4 0 9 6 1 2 0 <i>For the right angle 053 layout, KNB must be replaced by KXB (non ESA qualified, details on page 20)</i>																																																																								
5 Molding polarity	<table border="1"> <thead> <tr> <th colspan="4">NF C-UTE C 93-424 MIL-C-55302 ESA/ESCC 3401/01601B SPACE GRADE</th> <th colspan="4">NF C-UTE C 93-424 MIL-C-55302 ESA/ESCC 3401/01601B SPACE GRADE</th> <th colspan="4">NF C-UTE C 93-424 MIL-C-55302 ESA/ESCC 3401/01601B SPACE GRADE</th> </tr> </thead> <tbody> <tr> <td>12</td><td>14</td><td>54</td><td>54</td><td>Female plug</td> <td>1A</td><td>1C</td><td>-</td><td>5A</td><td>Tinned female plug**</td> <td>26</td><td>28</td><td>-</td><td>46</td><td>Tinned female receptacle*</td> </tr> <tr> <td>13</td><td>15</td><td>55</td><td>55</td><td>Male plug</td> <td>1B</td><td>1D</td><td>-</td><td>5B</td><td>Tinned male plug**</td> <td>27</td><td>29</td><td>-</td><td>47</td><td>Tinned male receptacle*</td> </tr> <tr> <td>16</td><td>18</td><td>-</td><td>56</td><td>Tinned female plug*</td> <td>22</td><td>24</td><td>44</td><td>44</td><td>Female receptacle</td> <td>2A</td><td>2C</td><td>-</td><td>-</td><td>Tinned female receptacle**</td> </tr> <tr> <td>17</td><td>19</td><td>-</td><td>57</td><td>Tinned male plug*</td> <td>23</td><td>25</td><td>45</td><td>45</td><td>Male receptacle</td> <td>2B</td><td>2D</td><td>-</td><td>-</td><td>Tinned male receptacle**</td> </tr> </tbody> </table>	NF C-UTE C 93-424 MIL-C-55302 ESA/ESCC 3401/01601B SPACE GRADE				NF C-UTE C 93-424 MIL-C-55302 ESA/ESCC 3401/01601B SPACE GRADE				NF C-UTE C 93-424 MIL-C-55302 ESA/ESCC 3401/01601B SPACE GRADE				12	14	54	54	Female plug	1A	1C	-	5A	Tinned female plug**	26	28	-	46	Tinned female receptacle*	13	15	55	55	Male plug	1B	1D	-	5B	Tinned male plug**	27	29	-	47	Tinned male receptacle*	16	18	-	56	Tinned female plug*	22	24	44	44	Female receptacle	2A	2C	-	-	Tinned female receptacle**	17	19	-	57	Tinned male plug*	23	25	45	45	Male receptacle	2B	2D	-	-	Tinned male receptacle**
NF C-UTE C 93-424 MIL-C-55302 ESA/ESCC 3401/01601B SPACE GRADE				NF C-UTE C 93-424 MIL-C-55302 ESA/ESCC 3401/01601B SPACE GRADE				NF C-UTE C 93-424 MIL-C-55302 ESA/ESCC 3401/01601B SPACE GRADE																																																																	
12	14	54	54	Female plug	1A	1C	-	5A	Tinned female plug**	26	28	-	46	Tinned female receptacle*																																																											
13	15	55	55	Male plug	1B	1D	-	5B	Tinned male plug**	27	29	-	47	Tinned male receptacle*																																																											
16	18	-	56	Tinned female plug*	22	24	44	44	Female receptacle	2A	2C	-	-	Tinned female receptacle**																																																											
17	19	-	57	Tinned male plug*	23	25	45	45	Male receptacle	2B	2D	-	-	Tinned male receptacle**																																																											
6 Termination styles	<table border="1"> <tbody> <tr> <td>10</td><td>Through board solder - 90° - length 3 mm</td> <td>21</td><td>Double crimp</td> <td>51</td><td>Wire wrap (3 wrapping levels)</td> </tr> <tr> <td>11</td><td>Through board solder - 90° - length 4 mm</td> <td>30</td><td>Through board solder - straight</td> <td>91</td><td>Female - male</td> </tr> <tr> <td>20</td><td>Crimp</td> <td>40</td><td>Solder bucket</td> <td></td><td></td> </tr> </tbody> </table>	10	Through board solder - 90° - length 3 mm	21	Double crimp	51	Wire wrap (3 wrapping levels)	11	Through board solder - 90° - length 4 mm	30	Through board solder - straight	91	Female - male	20	Crimp	40	Solder bucket																																																								
10	Through board solder - 90° - length 3 mm	21	Double crimp	51	Wire wrap (3 wrapping levels)																																																																				
11	Through board solder - 90° - length 4 mm	30	Through board solder - straight	91	Female - male																																																																				
20	Crimp	40	Solder bucket																																																																						
7 Mounting hardware	<p>Guide Style (consult us for special guides)</p> <table border="1"> <tbody> <tr> <td>110</td><td>Male polarized, transverse mount, standard plug</td> <td>145</td><td>Male polarized, transverse mount on receptacle only</td> <td>131</td><td>Male unpolarized, transverse mount</td> </tr> <tr> <td>111</td><td>Male polarized, vertical mount</td> <td>190</td><td>Female power or mass contact, vertical mount</td> <td>132</td><td>Female unpolarized, transverse mount</td> </tr> <tr> <td>113</td><td>Male polarized, float mount</td> <td>125</td><td>Male unpolarized, transverse mount</td> <td>133</td><td>Female all polarized, transverse mount</td> </tr> <tr> <td>121</td><td>Female polarized, vertical mount</td> <td>126</td><td>Female unpolarized, vertical mount</td> <td>191</td><td>Male power or mass contact, vertical mount</td> </tr> <tr> <td>123</td><td>Female polarized, float mount</td> <td>127</td><td>Male unpolarized, vertical mount</td> <td></td><td></td> </tr> <tr> <td>124</td><td>Female polarized, transverse mount</td> <td>130</td><td>Female unpolarized, vertical mount</td> <td></td><td></td> </tr> </tbody> </table> <p>Locking Styles</p> <table border="1"> <thead> <tr> <th colspan="2">MALE PLUG</th> <th colspan="2">FEMALE RECEPTACLE</th> </tr> </thead> <tbody> <tr> <td>201</td><td>1/4 turn, free connector</td> <td>202</td><td>1/4 turn, vertical mount</td> <td>212</td><td>Jackscrew, transverse mount</td> </tr> <tr> <td>203</td><td>1/4 turn, transverse mount</td> <td>204</td><td>1/4 turn, transverse mount</td> <td>215</td><td>Jackscrew, vertical mount</td> </tr> <tr> <td>207</td><td>Jackscrew, free connector</td> <td>208</td><td>Jackscrew, transverse mount</td> <td>219</td><td>Jackscrew, vertical mount</td> </tr> <tr> <td>211</td><td>Jackscrew, free connector</td> <td>210</td><td>Jackscrew, free connector</td> <td>232</td><td>Jackscrew, with operation button</td> </tr> <tr> <td>290</td><td>Jackscrew, vertical mount</td> <td></td><td></td> <td></td><td></td> </tr> </tbody> </table>	110	Male polarized, transverse mount, standard plug	145	Male polarized, transverse mount on receptacle only	131	Male unpolarized, transverse mount	111	Male polarized, vertical mount	190	Female power or mass contact, vertical mount	132	Female unpolarized, transverse mount	113	Male polarized, float mount	125	Male unpolarized, transverse mount	133	Female all polarized, transverse mount	121	Female polarized, vertical mount	126	Female unpolarized, vertical mount	191	Male power or mass contact, vertical mount	123	Female polarized, float mount	127	Male unpolarized, vertical mount			124	Female polarized, transverse mount	130	Female unpolarized, vertical mount			MALE PLUG		FEMALE RECEPTACLE		201	1/4 turn, free connector	202	1/4 turn, vertical mount	212	Jackscrew, transverse mount	203	1/4 turn, transverse mount	204	1/4 turn, transverse mount	215	Jackscrew, vertical mount	207	Jackscrew, free connector	208	Jackscrew, transverse mount	219	Jackscrew, vertical mount	211	Jackscrew, free connector	210	Jackscrew, free connector	232	Jackscrew, with operation button	290	Jackscrew, vertical mount						
110	Male polarized, transverse mount, standard plug	145	Male polarized, transverse mount on receptacle only	131	Male unpolarized, transverse mount																																																																				
111	Male polarized, vertical mount	190	Female power or mass contact, vertical mount	132	Female unpolarized, transverse mount																																																																				
113	Male polarized, float mount	125	Male unpolarized, transverse mount	133	Female all polarized, transverse mount																																																																				
121	Female polarized, vertical mount	126	Female unpolarized, vertical mount	191	Male power or mass contact, vertical mount																																																																				
123	Female polarized, float mount	127	Male unpolarized, vertical mount																																																																						
124	Female polarized, transverse mount	130	Female unpolarized, vertical mount																																																																						
MALE PLUG		FEMALE RECEPTACLE																																																																							
201	1/4 turn, free connector	202	1/4 turn, vertical mount	212	Jackscrew, transverse mount																																																																				
203	1/4 turn, transverse mount	204	1/4 turn, transverse mount	215	Jackscrew, vertical mount																																																																				
207	Jackscrew, free connector	208	Jackscrew, transverse mount	219	Jackscrew, vertical mount																																																																				
211	Jackscrew, free connector	210	Jackscrew, free connector	232	Jackscrew, with operation button																																																																				
290	Jackscrew, vertical mount																																																																								

* For 90° & straight terminations (splicing on PCB)
 ** RoHS compliant for 90° & straight terminations (splicing on PCB)

Hypertac & ESA Correspondence Table

HYPERTAC **KNB**

34 01 016 01 B

1

2

3

4

5

6

1 ESCC component number																																																																																																				
2 Mounting	<table border="1"> <thead> <tr> <th colspan="4">HYPERTAC</th> <th colspan="4">ESA</th> </tr> </thead> <tbody> <tr> <td>Plug KNB 017</td><td>01</td> <td>Plug KNB 096</td><td>08</td> <td>Receptacle KNB 053</td><td>16</td> <td>Plug KNB 072</td><td>56</td> <td>Plug KNC 098</td><td>62</td> </tr> <tr> <td>Plug KNB 029</td><td>02</td> <td>Plug KNB 120</td><td>10</td> <td>Receptacle KNB 065</td><td>17</td> <td>Receptacle KNB 072</td><td>57</td> <td>Receptacle KNC 098</td><td>63</td> </tr> <tr> <td>Plug KNB 041</td><td>03</td> <td>Plug KNC 160</td><td>12</td> <td>Receptacle KNB 084</td><td>19</td> <td>Plug KNC 062</td><td>58</td> <td></td><td></td> </tr> <tr> <td>Plug KNB 053</td><td>04</td> <td>Receptacle KNB 017</td><td>13</td> <td>Receptacle KNB 096</td><td>20</td> <td>Receptacle KNC 062</td><td>59</td> <td></td><td></td> </tr> <tr> <td>Plug KNB 065</td><td>05</td> <td>Receptacle KNB 029</td><td>14</td> <td>Receptacle KNB 120</td><td>22</td> <td>Plug KNC 080</td><td>60</td> <td></td><td></td> </tr> <tr> <td>Plug KNB 084</td><td>07</td> <td>Receptacle KNB 041</td><td>15</td> <td>Receptacle KNC 160</td><td>24</td> <td>Receptacle KNC 080</td><td>61</td> <td></td><td></td> </tr> </tbody> </table> <table border="1"> <tr> <td colspan="4">REMINDER SPATIAL P.P.P. (Party Polarity Protection)</td> <td colspan="4">EXAMPLE</td> </tr> <tr> <td>Female receptacle</td><td>44</td> <td>Plug female</td><td>54</td> <td colspan="4">KNC 029 44 40 113</td> </tr> <tr> <td>Male receptacle</td><td>45</td> <td>Plug male</td><td>55</td> <td colspan="4">P.P.P.</td> </tr> </table>								HYPERTAC				ESA				Plug KNB 017	01	Plug KNB 096	08	Receptacle KNB 053	16	Plug KNB 072	56	Plug KNC 098	62	Plug KNB 029	02	Plug KNB 120	10	Receptacle KNB 065	17	Receptacle KNB 072	57	Receptacle KNC 098	63	Plug KNB 041	03	Plug KNC 160	12	Receptacle KNB 084	19	Plug KNC 062	58			Plug KNB 053	04	Receptacle KNB 017	13	Receptacle KNB 096	20	Receptacle KNC 062	59			Plug KNB 065	05	Receptacle KNB 029	14	Receptacle KNB 120	22	Plug KNC 080	60			Plug KNB 084	07	Receptacle KNB 041	15	Receptacle KNC 160	24	Receptacle KNC 080	61			REMINDER SPATIAL P.P.P. (Party Polarity Protection)				EXAMPLE				Female receptacle	44	Plug female	54	KNC 029 44 40 113				Male receptacle	45	Plug male	55	P.P.P.			
HYPERTAC				ESA																																																																																																
Plug KNB 017	01	Plug KNB 096	08	Receptacle KNB 053	16	Plug KNB 072	56	Plug KNC 098	62																																																																																											
Plug KNB 029	02	Plug KNB 120	10	Receptacle KNB 065	17	Receptacle KNB 072	57	Receptacle KNC 098	63																																																																																											
Plug KNB 041	03	Plug KNC 160	12	Receptacle KNB 084	19	Plug KNC 062	58																																																																																													
Plug KNB 053	04	Receptacle KNB 017	13	Receptacle KNB 096	20	Receptacle KNC 062	59																																																																																													
Plug KNB 065	05	Receptacle KNB 029	14	Receptacle KNB 120	22	Plug KNC 080	60																																																																																													
Plug KNB 084	07	Receptacle KNB 041	15	Receptacle KNC 160	24	Receptacle KNC 080	61																																																																																													
REMINDER SPATIAL P.P.P. (Party Polarity Protection)				EXAMPLE																																																																																																
Female receptacle	44	Plug female	54	KNC 029 44 40 113																																																																																																
Male receptacle	45	Plug male	55	P.P.P.																																																																																																
3 Termination style	<table border="1"> <thead> <tr> <th colspan="4">HYPERTAC</th> <th colspan="4">ESA</th> </tr> </thead> <tbody> <tr> <td>Bent male 10</td><td>MC</td> <td>Solder bucket male 40</td><td>MS</td> <td>Crimp female 20</td><td>FR</td> <td colspan="2">Female-male 91</td><td>FM</td> </tr> <tr> <td>Bent long male 11</td><td>ML</td> <td>Mini-wrapping male 51</td><td>MY</td> <td>Straight female 30</td><td>FD</td> <td colspan="3"></td> </tr> <tr> <td>Crimp male 20</td><td>MR</td> <td>Bent female 10</td><td>FC</td> <td>Solder bucket female 40</td><td>FS</td> <td colspan="3"></td> </tr> <tr> <td>Straight male 30</td><td>MD</td> <td>Bent long female 11</td><td>FL</td> <td>Mini-wrapping female 51</td><td>FY</td> <td colspan="3"></td> </tr> </tbody> </table>								HYPERTAC				ESA				Bent male 10	MC	Solder bucket male 40	MS	Crimp female 20	FR	Female-male 91		FM	Bent long male 11	ML	Mini-wrapping male 51	MY	Straight female 30	FD				Crimp male 20	MR	Bent female 10	FC	Solder bucket female 40	FS				Straight male 30	MD	Bent long female 11	FL	Mini-wrapping female 51	FY																																																			
HYPERTAC				ESA																																																																																																
Bent male 10	MC	Solder bucket male 40	MS	Crimp female 20	FR	Female-male 91		FM																																																																																												
Bent long male 11	ML	Mini-wrapping male 51	MY	Straight female 30	FD																																																																																															
Crimp male 20	MR	Bent female 10	FC	Solder bucket female 40	FS																																																																																															
Straight male 30	MD	Bent long female 11	FL	Mini-wrapping female 51	FY																																																																																															
4 Locking type On left side	<table border="1"> <thead> <tr> <th colspan="4">HYPERTAC</th> <th colspan="4">ESA</th> </tr> </thead> <tbody> <tr> <td>Guideless connector</td><td>00</td> <td>KNB 145</td><td>40</td> <td>KNC 10 209</td><td>49</td> <td>KNB 11 125</td><td>71</td> <td>KNB 11 208</td><td>79</td> </tr> <tr> <td>KNB 131</td><td>31</td> <td>KNB 124</td><td>41</td> <td>KN 210</td><td>50</td> <td>KNB 11 110</td><td>72</td> <td>KN 219</td><td>80</td> </tr> <tr> <td>KNB 132</td><td>32</td> <td>KNC 10 230</td><td>43</td> <td>KN 211</td><td>51</td> <td>KNB 10 230</td><td>73</td> <td>KN 290*</td><td>81</td> </tr> <tr> <td>KNB 10 110</td><td>33</td> <td>KN 232</td><td>45</td> <td>KNB 212</td><td>52</td> <td>KNC 124</td><td>74</td> <td></td><td></td> </tr> <tr> <td>KNC 10 110</td><td>34</td> <td>KN 231</td><td>46</td> <td>KN 215</td><td>53</td> <td>KNC 132</td><td>75</td> <td></td><td></td> </tr> <tr> <td>KN 111</td><td>35</td> <td>KN 207</td><td>47</td> <td>KN 123</td><td>54</td> <td>KNC 11 110</td><td>76</td> <td></td><td></td> </tr> <tr> <td>KN 121</td><td>36</td> <td>KNB 10 208</td><td>48</td> <td>KN 113</td><td>55</td> <td>KNC 11 125</td><td>77</td> <td></td><td></td> </tr> </tbody> </table>								HYPERTAC				ESA				Guideless connector	00	KNB 145	40	KNC 10 209	49	KNB 11 125	71	KNB 11 208	79	KNB 131	31	KNB 124	41	KN 210	50	KNB 11 110	72	KN 219	80	KNB 132	32	KNC 10 230	43	KN 211	51	KNB 10 230	73	KN 290*	81	KNB 10 110	33	KN 232	45	KNB 212	52	KNC 124	74			KNC 10 110	34	KN 231	46	KN 215	53	KNC 132	75			KN 111	35	KN 207	47	KN 123	54	KNC 11 110	76			KN 121	36	KNB 10 208	48	KN 113	55	KNC 11 125	77																
HYPERTAC				ESA																																																																																																
Guideless connector	00	KNB 145	40	KNC 10 209	49	KNB 11 125	71	KNB 11 208	79																																																																																											
KNB 131	31	KNB 124	41	KN 210	50	KNB 11 110	72	KN 219	80																																																																																											
KNB 132	32	KNC 10 230	43	KN 211	51	KNB 10 230	73	KN 290*	81																																																																																											
KNB 10 110	33	KN 232	45	KNB 212	52	KNC 124	74																																																																																													
KNC 10 110	34	KN 231	46	KN 215	53	KNC 132	75																																																																																													
KN 111	35	KN 207	47	KN 123	54	KNC 11 110	76																																																																																													
KN 121	36	KNB 10 208	48	KN 113	55	KNC 11 125	77																																																																																													
5 Locking type In center	<p>00 For 2 guide connectors</p> <p>-- For 3 guide connectors (see table 4, Locking type - On left side)</p> <table border="1"> <thead> <tr> <th colspan="4">HYPERTAC</th> <th colspan="4">ESA</th> </tr> </thead> <tbody> <tr> <td>KNB 10 125</td><td>26</td> <td>KNC 10 125</td><td>27</td> <td>KN 127</td><td>28</td> <td colspan="2">KN 126</td><td>29</td> </tr> </tbody> </table>								HYPERTAC				ESA				KNB 10 125	26	KNC 10 125	27	KN 127	28	KN 126		29																																																																											
HYPERTAC				ESA																																																																																																
KNB 10 125	26	KNC 10 125	27	KN 127	28	KN 126		29																																																																																												
6 Locking type On right side	(see table 4, Locking type - On left side)																																																																																																			

* Please consult us

Contact Terminations

Plug

Receptacle

Male

Female

Female

Male

90° Through board solder

Ref: **10** (X=3) Ref : **MC & FC** - Ref: **11** (X=4) Ref : **ML & FL**

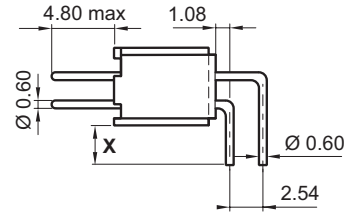
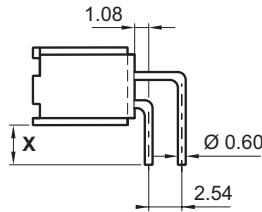
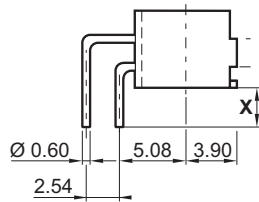
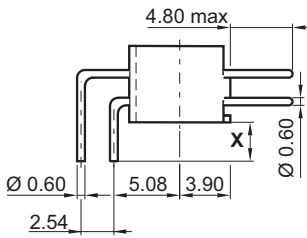

Crimp (AWG 28-26 & 24-22)

Ref: **20** Ref : **MR & FR**

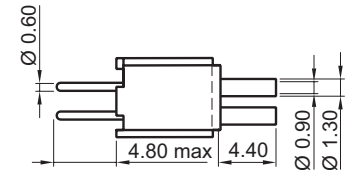
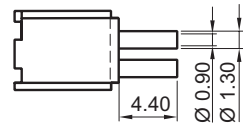
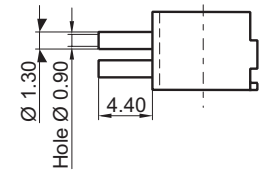
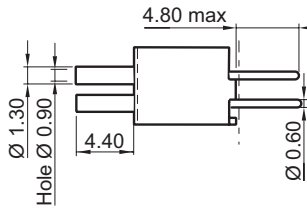

Crimp (AWG 28-26 & 24-22) & Crimp on sheath (Ø 1.45)

Ref: **21**

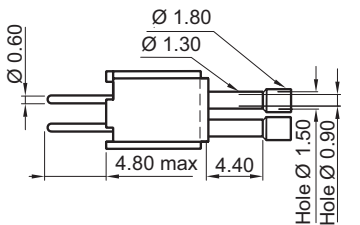
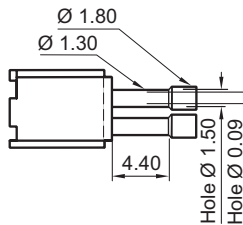
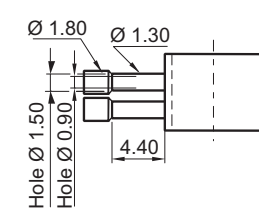
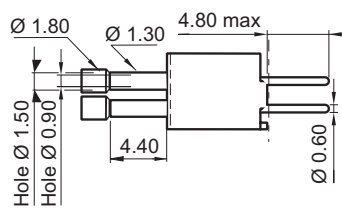

Straight through board solder

Ref: **30** Ref : **MD & FD** Ref **31**

See: 90° Through board solder

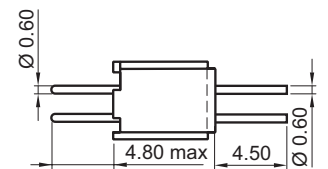
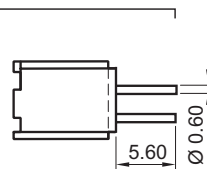
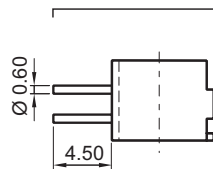
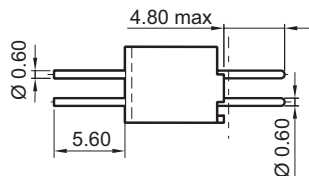

Contact Terminations

Plug

Receptacle

Male

Female

Female

Male

Solder bucket (AWG 22 max)

Ref: **40** Ref : **MS & FS**

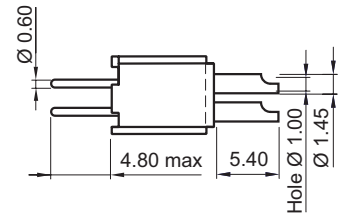
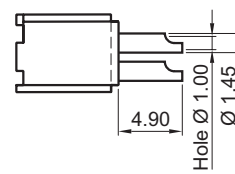
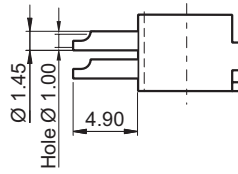
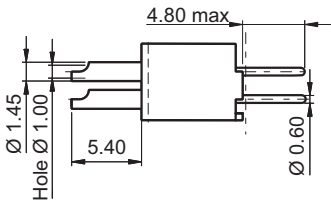

Wire wrap (3 wrapping levels)

Ref: **51** Ref : **MY & FY**

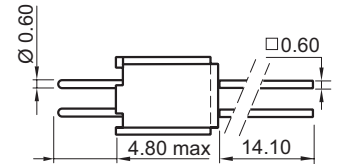
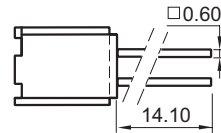
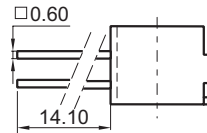
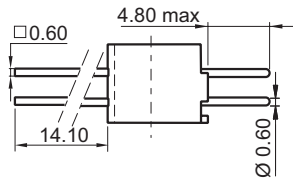

Saver (male-male)

Ref: **90**

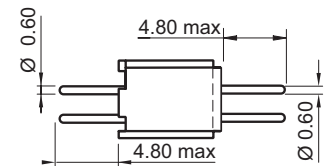
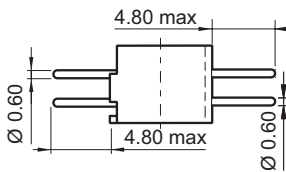

Saver (female-male)

Ref: **91** Ref : **FM**

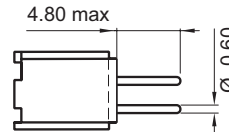
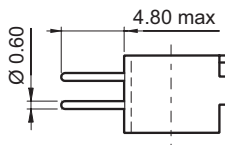

Connector Dimensions

Plug

17 to 65 contacts

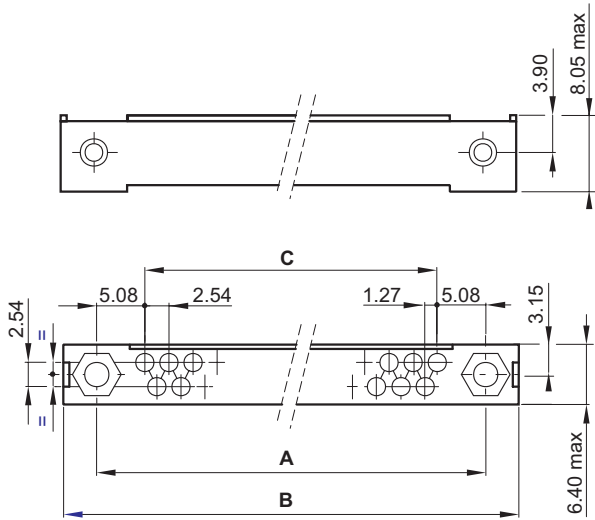

Receptacle

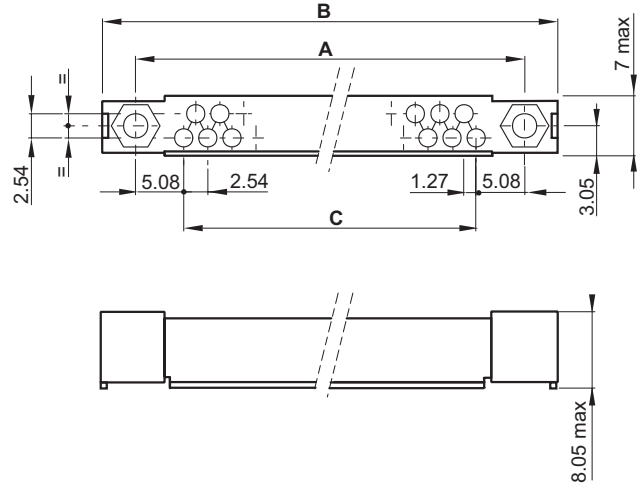

72 to 120 contacts

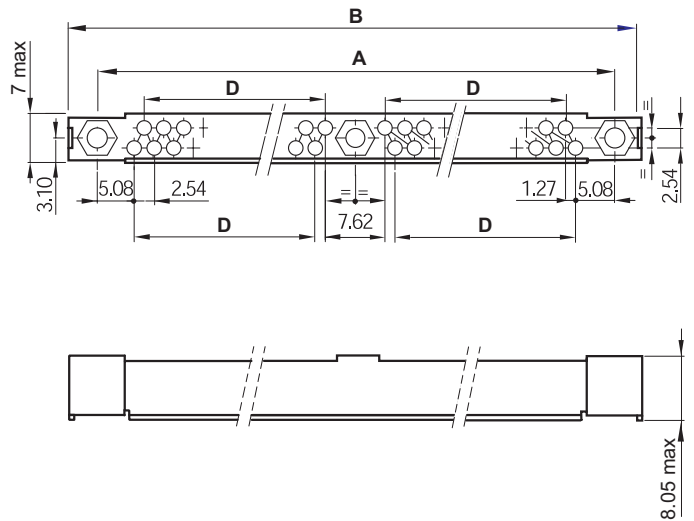
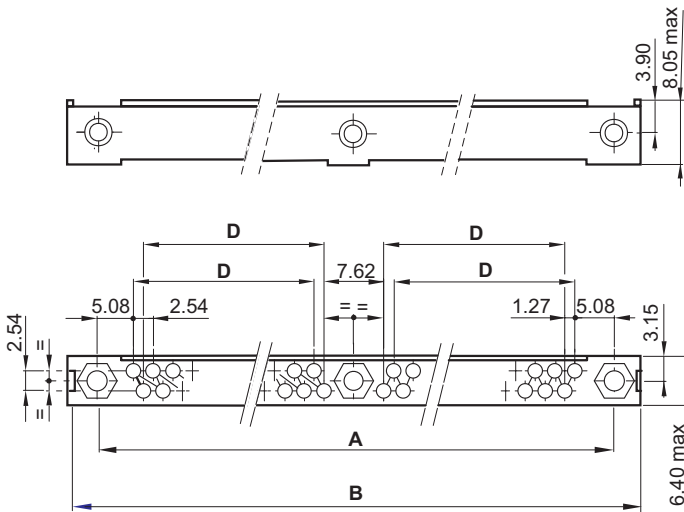

No. of contacts	17	29	41	53	65	72	84	96	120
A	30.48	45.72	60.96	76.20	91.44	106.68	121.92	137.16	167.64
B max	38.50	53.70	69.00	84.20	99.50	114.70	129.90	145.20	175.50
C	20.32	35.56	50.80	66.04	81.28	-	-	-	-
D	-	-	-	-	-	43.18	50.80	58.42	73.66

Guide Styles

Plug & Receptacle

Male

Polarized vertical mount

Ref: 111 Ref : 35

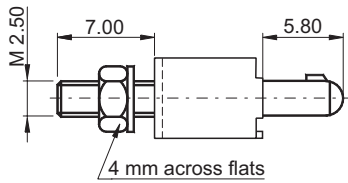

Polarized vertical float mount

Ref: 113 Ref : 55

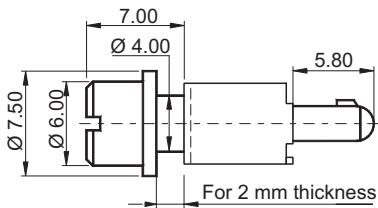

Unpolarized vertical mount

Ref: 127 Ref : 28

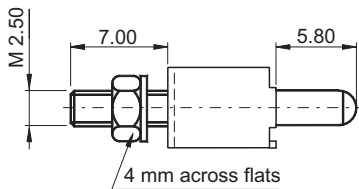

Unpolarized transverse mount

Ref: 131 Ref : 31

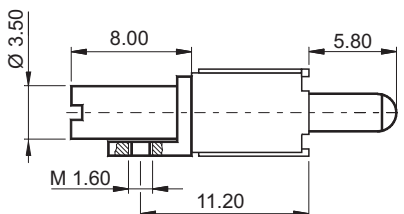

Female

Polarized vertical mount

Ref: 121 Ref : 36

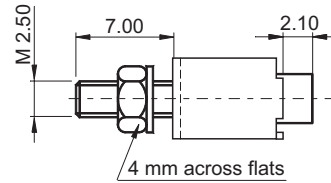

Polarized vertical float mount

Ref: 123 Ref : 54

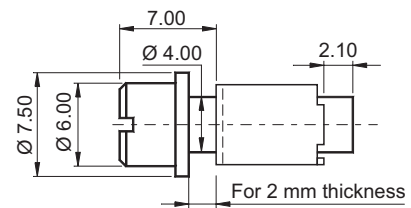

Polarized transverse mount

Ref: 124 Ref : 41

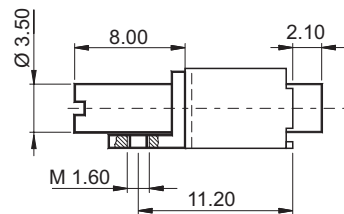

Unpolarized vertical mount

Ref: 126 Ref : 29

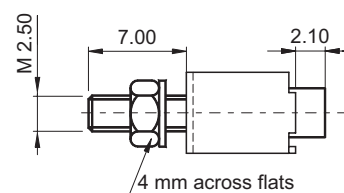

Guide Styles

Plug & Receptacle

Male

Polarized transverse mount

Ref: **145** Ref : 40

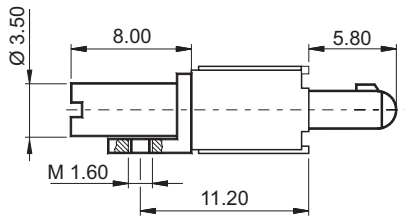

Female

All polarized vertical mount

Ref: **130**

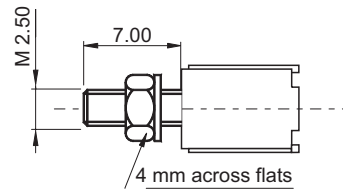

Unpolarized transverse mount

Ref: **132** Ref : 32

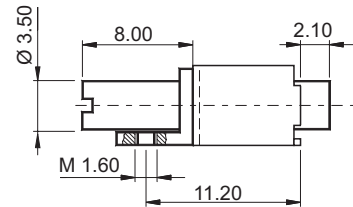

All polarized transverse mount

Ref: **133**

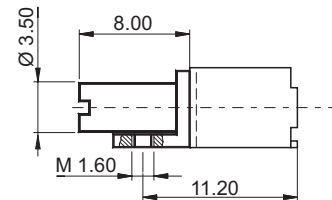

Guide Styles

Plug & Receptacle

Male

Power or mass transverse mount

Ref: **191**

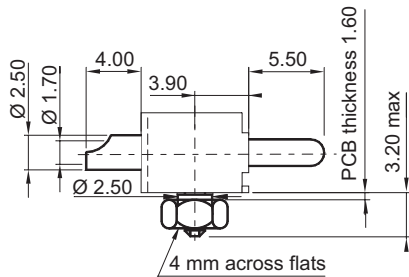

Female

Power or mass vertical mount

Ref: **190**

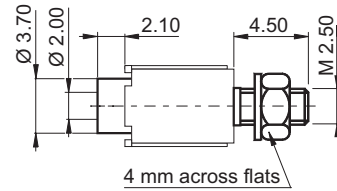

Male plug only

Polarized transverse mount

Ref: **10 110** Ref: **33** X=1.60 Y=3.20
 Ref: **11 110** Ref: **72** X=2.40 Y=4.90

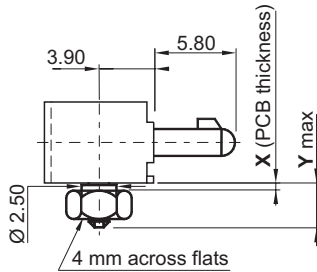

Unpolarized transverse mount

Ref: **10 125** Ref: **26** X=1.60 Y=3.20
 Ref: **11 125** Ref: **71** X=2.40 Y=4.90

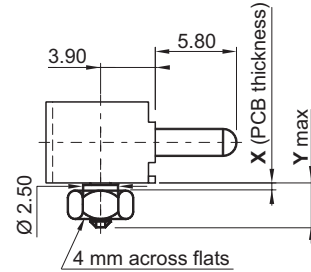

Locking Device Compatibility Chart

		R	P	R	P	R	P	R	P	R	P	R	P	R	P				
Compatible																Receptacle	Molding		
																Plug			
P																	290		
R																			
P																	231		
R																			
P																	211		
R																			
P																	207		
R																			
P																	205		
R																			
P																	203		
R																			
P																	201		
R																			
		Receptacle																	
		Plug																	
Molding				232		219		215		212		210		208		204		202	
																Male locking devices			
																		Female locking devices	

Male Locking Styles

Plug & Receptacle

Jack 1/4 turn lock, free connector

Ref: **201**

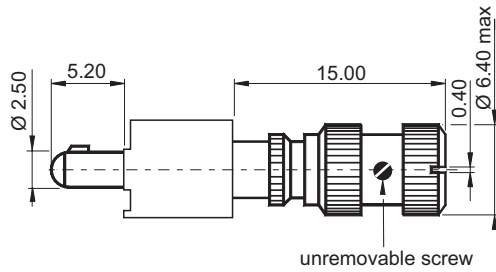

Jackscrew, free connector

Ref: **211** Ref : **51**

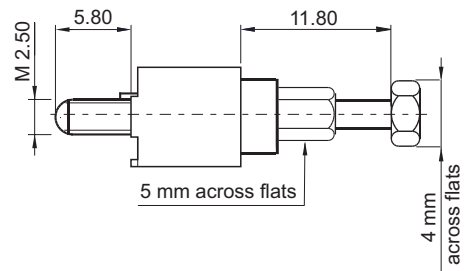

Jack 1/4 turn lock, transverse mount

Ref: **203** PCB thickness **1.60**

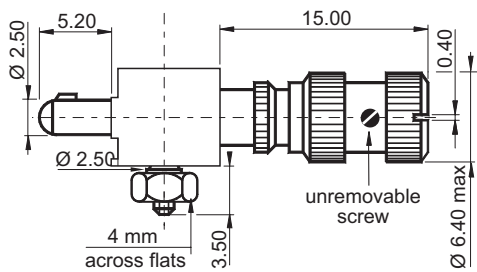

Jackscrew, vertical mount

Ref: **231** Ref : **46**

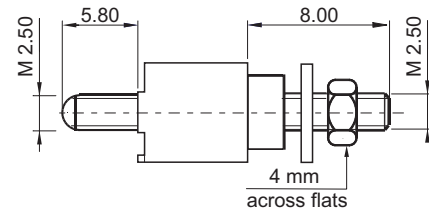

Jackscrew, free connector

Ref: **207** Ref : **47**

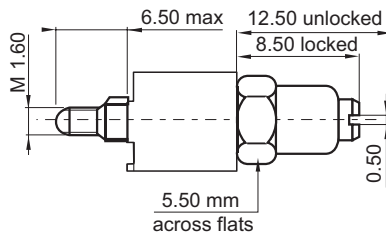

Jackscrew, vertical mount

Ref: **290** Ref : **81**

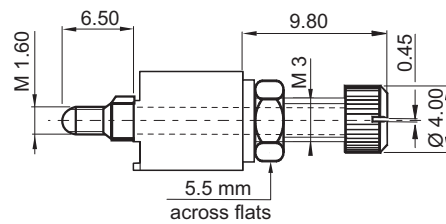

Female Locking Styles

Plug & Receptacle

Jack 1/4 turn lock, vertical mount

Ref: **202**

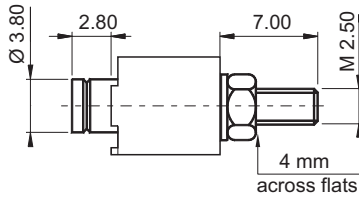

Jackscrew, transverse mount

Ref: **212** Ref : **52**

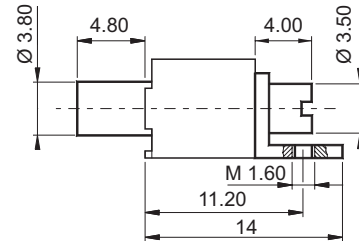

Jack 1/4 turn lock, transverse mount

Ref: **204**

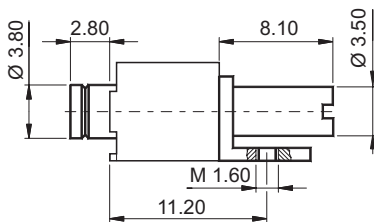

Jackscrew, vertical mount

Ref: **215** Ref : **53**

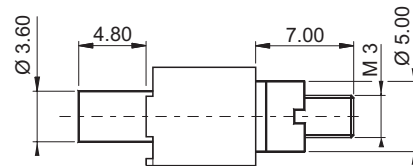

Jackscrew, transverse mount

Ref: **10 208** Ref : **48** PCB thickness 1.60
 Ref: **11 208** Ref : **79** PCB thickness 2.40

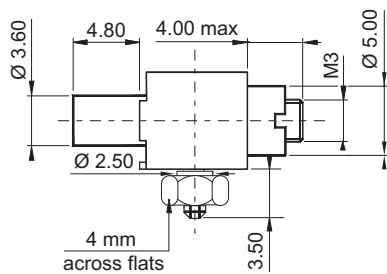

Jackscrew, vertical mount

Ref: **219** Ref : **80**

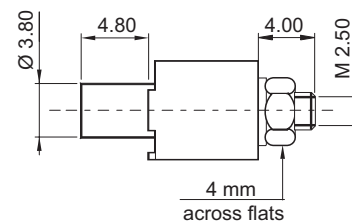

Jackscrew, free connector

Ref: **210** Ref : **50**

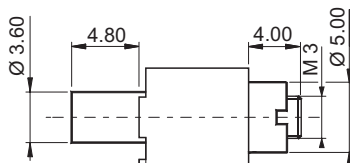

Rotating jackscrew, free connector

Ref: **232** Ref : **45**

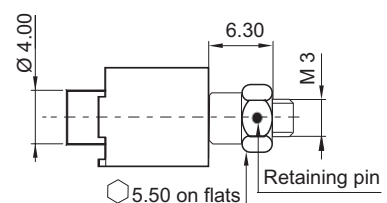

Mating Side Layout View

Plug

Receptacle

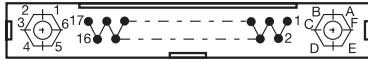

017

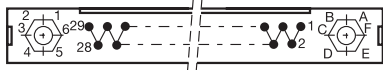
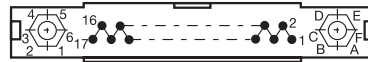

029

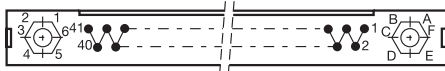
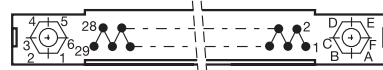

041

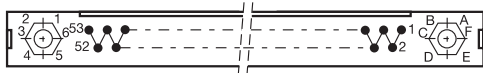
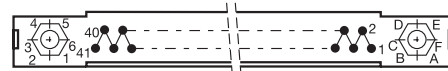

053

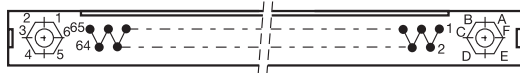
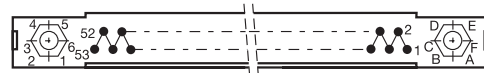

065

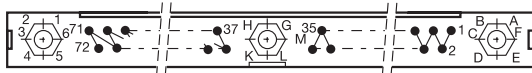
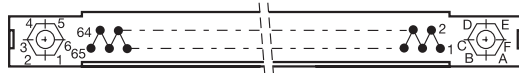

072

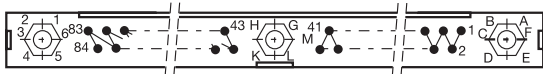

084

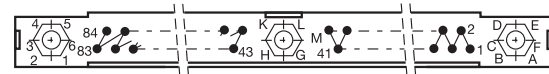

096

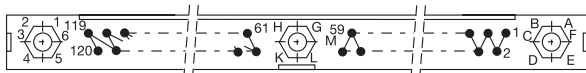
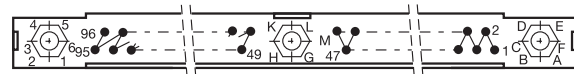

120

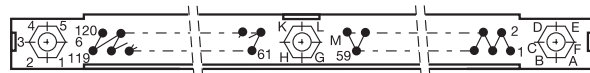

Panel Preparation Details

17 to 65 Contacts

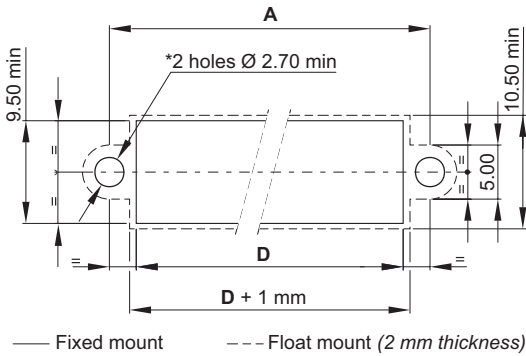

72 to 120 Contacts

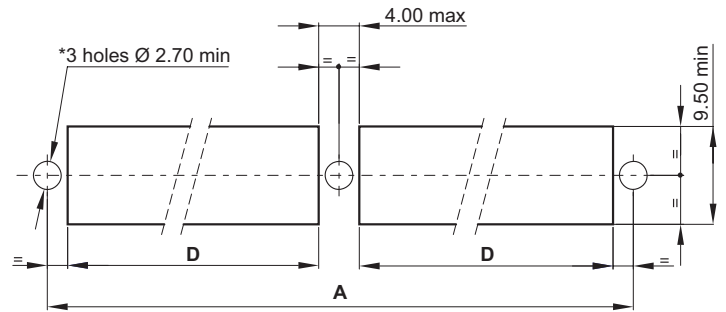

Panel: female or male, plug or receptacle, terminations 20 - 40 - 51
Guide styles: 111 - 121 - 126 - 127 - 130 - 190 (Fixed Mount) - 113 - 123 (Float Mount)
Locking styles: 202 - 215* - 219 - 231
 * for ref: 215, holes \varnothing 3.20 mm

No. of contacts	17	29	41	53	65	72	84	96	120
A	30.48	45.72	60.96	76.20	91.44	106.68	121.92	137.16	167.64
D	25.90	41.10	56.40	71.60	86.90	48.50	56.00	63.30	78.80

Board Preparation Details

Mother board

17 to 65 Contacts

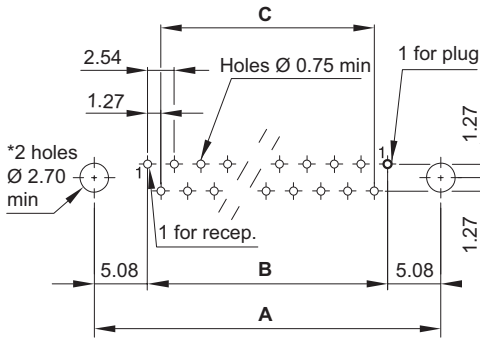

72 to 120 Contacts

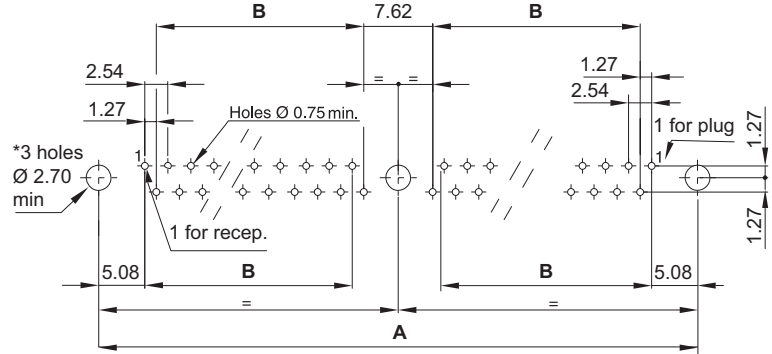

Mother Board: female or male, plug or receptacle, straight solder termination

Guide styles: 111 - 121 - 126 - 127 - 130 - 190 Locking styles: 202 - 215* - 219 - 231

* for ref: 215, holes Ø 3.20 mm

Daughter board

17 to 65 Contacts

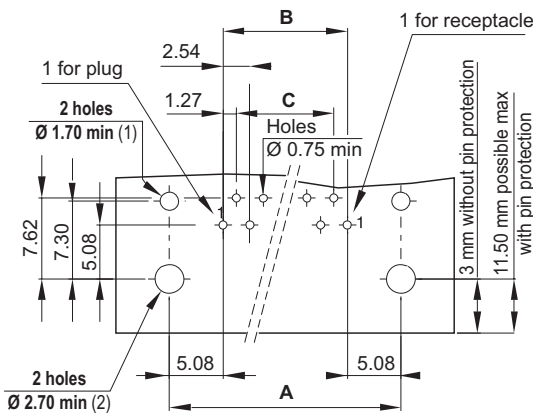

72 to 120 Contacts

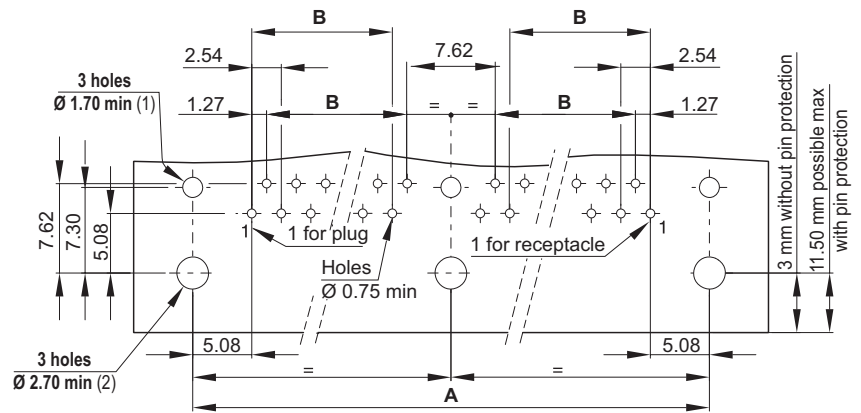

Daughter Board: female or male, plug or receptacle, 90° termination

(1) **Guide styles:** 124 - 131 - 132 - 133 - 145 Locking styles: 204 - 212

(2) **Guide styles:** 110 - 125 - 191 Locking styles: 203 - 208

No. of contacts	17	29	41	53	65	72	84	96	120
A	30.48	45.72	60.96	76.20	91.44	106.68	121.92	137.16	167.64
B	20.32	35.56	50.80	66.04	81.28	43.18	50.80	58.42	73.66
D	17.78	33.02	48.26	63.50	78.74	-	-	-	-

Technical Characteristics

Contact diameter	HYPERTAC® type Ø 0.60 mm rear removable
Number of contact	53
Pitch	2.54 mm between rows - 1.27 mm between quicuncial contacts
Rows	2

Materials & Platings

Contact	Brass or bronze
Molding	Glass fiber filled diallyl - Phtalate
Guides	Stainless steel or nickel plated brass
Pin body	0.25 µm gold / 1.27 µm Ni
Socket body	0.25 µm gold / 1.27 µm Ni on active area; 1.27 µm Ni on non active area
Socket wires	1 µm gold / 0.20 µm Ni

Electrical

Current rating (at 25°C)	3 A max.
Dielectric withstanding voltage	1200 Vrms
Contact resistance	≤8 mΩ
Insulation resistance	>104 MΩ (500 Vcc)

Mechanical

Mating & unmating cycle	5000
Guiding	By two outside guides (2 guiding styles) and one central guide (3 guiding styles)
Keying	By rotating of outside polarized guides (up to 36 keying)

Environmental

Temperature range	-55° C to 125° C
Conformity	NF C-UTE C 93-424

How To Order



1 Thermoplastic material	X																																																		
2 Molding polarity	<p>NF C-UTE C 93-424 MIL-C-55302 SPACE GRADE</p> <table border="1"> <tr><td>12</td><td>14</td><td>54</td><td>Female plug</td></tr> <tr><td>13</td><td>15</td><td>55</td><td>Male plug</td></tr> <tr><td>16</td><td>18</td><td>56</td><td>Tinned female plug*</td></tr> <tr><td>17</td><td>19</td><td>57</td><td>Tinned male plug*</td></tr> </table>	12	14	54	Female plug	13	15	55	Male plug	16	18	56	Tinned female plug*	17	19	57	Tinned male plug*	<p>NF C-UTE C 93-424 MIL-C-55302 SPACE GRADE</p> <table border="1"> <tr><td>1A</td><td>1C</td><td>5A</td><td>Tinned female plug**</td></tr> <tr><td>1B</td><td>1D</td><td>5B</td><td>Tinned male plug**</td></tr> <tr><td>22</td><td>24</td><td>44</td><td>Female receptacle</td></tr> <tr><td>23</td><td>25</td><td>45</td><td>Male receptacle</td></tr> </table>	1A	1C	5A	Tinned female plug**	1B	1D	5B	Tinned male plug**	22	24	44	Female receptacle	23	25	45	Male receptacle	<p>NF C-UTE C 93-424 MIL-C-55302 SPACE GRADE</p> <table border="1"> <tr><td>26</td><td>28</td><td>46</td><td>Tinned female receptacle*</td></tr> <tr><td>27</td><td>29</td><td>47</td><td>Tinned male receptacle*</td></tr> <tr><td>2A</td><td>2C</td><td>-</td><td>Tinned female receptacle**</td></tr> <tr><td>2B</td><td>2D</td><td>-</td><td>Tinned male receptacle**</td></tr> </table>	26	28	46	Tinned female receptacle*	27	29	47	Tinned male receptacle*	2A	2C	-	Tinned female receptacle**	2B	2D	-	Tinned male receptacle**
12	14	54	Female plug																																																
13	15	55	Male plug																																																
16	18	56	Tinned female plug*																																																
17	19	57	Tinned male plug*																																																
1A	1C	5A	Tinned female plug**																																																
1B	1D	5B	Tinned male plug**																																																
22	24	44	Female receptacle																																																
23	25	45	Male receptacle																																																
26	28	46	Tinned female receptacle*																																																
27	29	47	Tinned male receptacle*																																																
2A	2C	-	Tinned female receptacle**																																																
2B	2D	-	Tinned male receptacle**																																																
3 Termination styles	<table border="1"> <tr><td>10</td><td>Through board solder - 90° - length 3 mm</td></tr> <tr><td>11</td><td>Through board solder - 90° - length 4 mm</td></tr> <tr><td>12</td><td>Through board solder - 90° - length 5.1 mm, plug only</td></tr> </table>	10	Through board solder - 90° - length 3 mm	11	Through board solder - 90° - length 4 mm	12	Through board solder - 90° - length 5.1 mm, plug only	<table border="1"> <tr><td>13</td><td>Through board solder - 90° - length 2.3 mm, plug only</td></tr> <tr><td>14</td><td>Through board solder - 90° - length 8 mm, receptacle only</td></tr> </table>	13	Through board solder - 90° - length 2.3 mm, plug only	14	Through board solder - 90° - length 8 mm, receptacle only																																							
10	Through board solder - 90° - length 3 mm																																																		
11	Through board solder - 90° - length 4 mm																																																		
12	Through board solder - 90° - length 5.1 mm, plug only																																																		
13	Through board solder - 90° - length 2.3 mm, plug only																																																		
14	Through board solder - 90° - length 8 mm, receptacle only																																																		
4 Mounting hardware	<p>Guide Style***</p> <table border="1"> <tr><td>110</td><td>Male polarized, transverse mount, standard plug</td><td>131</td><td>Male unpolarized, transverse mount</td></tr> <tr><td>121</td><td>Female polarized, vertical mount</td><td>145</td><td>Male polarized, transverse mount on receptacle only</td></tr> <tr><td>124</td><td>Female polarized, transverse mount</td><td>191</td><td>Male power or mass contact, vertical mount</td></tr> <tr><td>125</td><td>Male unpolarized, transverse mount</td><td></td><td></td></tr> </table> <p>Locking Styles***</p> <table border="1"> <tr> <td>FEMALE RECEPTACLE</td> <td></td> <td>MALE PLUG</td> </tr> <tr> <td>204</td><td>1/4 turn, transverse mount</td> <td>218</td><td>Jackscrew, transverse mount</td> </tr> <tr> <td></td><td></td> <td>203</td><td>1/4 turn, transverse mount</td> </tr> </table>			110	Male polarized, transverse mount, standard plug	131	Male unpolarized, transverse mount	121	Female polarized, vertical mount	145	Male polarized, transverse mount on receptacle only	124	Female polarized, transverse mount	191	Male power or mass contact, vertical mount	125	Male unpolarized, transverse mount			FEMALE RECEPTACLE		MALE PLUG	204	1/4 turn, transverse mount	218	Jackscrew, transverse mount			203	1/4 turn, transverse mount																					
110	Male polarized, transverse mount, standard plug	131	Male unpolarized, transverse mount																																																
121	Female polarized, vertical mount	145	Male polarized, transverse mount on receptacle only																																																
124	Female polarized, transverse mount	191	Male power or mass contact, vertical mount																																																
125	Male unpolarized, transverse mount																																																		
FEMALE RECEPTACLE		MALE PLUG																																																	
204	1/4 turn, transverse mount	218	Jackscrew, transverse mount																																																
		203	1/4 turn, transverse mount																																																

* No RoHS compliant = 16 et 17

** RoHS Compliant = 1A et 1B

Connector Dimensions

Plug

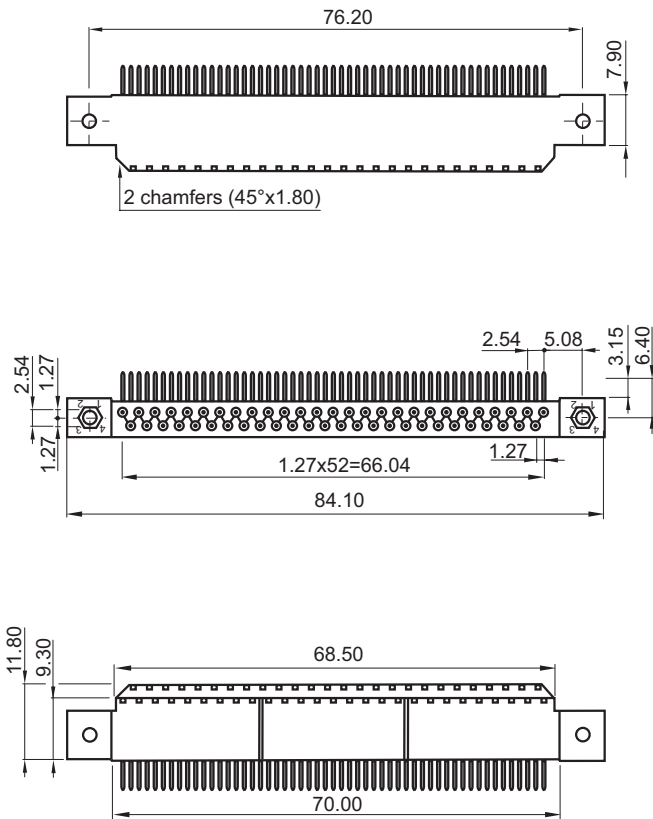

Receptacle

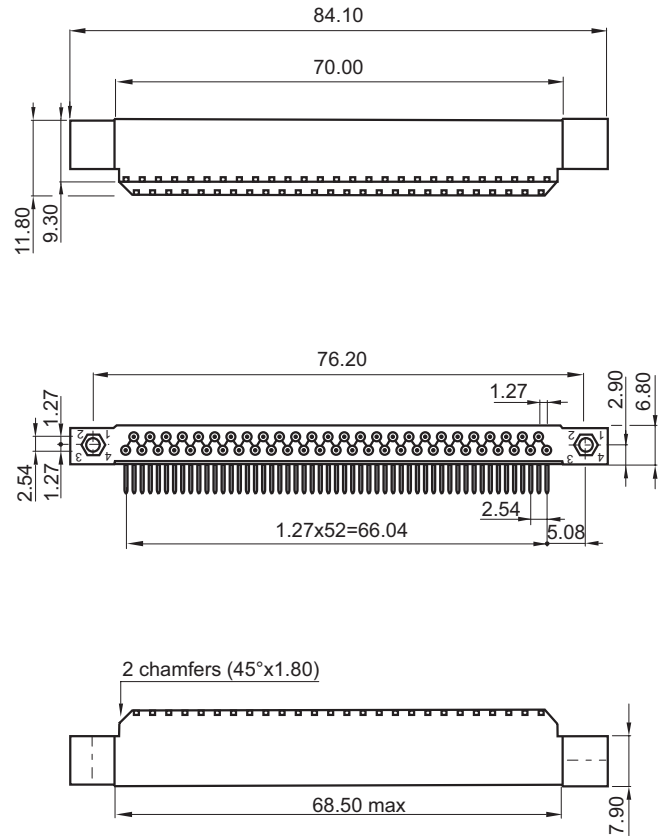

Technical Characteristics

Contact diameter	HYPERTAC® type Ø 0.60 mm rear removable
Number of contact	Up to 160
Pitch	2.54 mm between rows - 1.27 mm between quicuncial contacts
Rows	3

Materials & Platings

Contact	Brass or bronze	
Molding	Glass fiber filled diallyl - Phtalate	
Guides	Stainless steel or nickel plated brass	
	Standard	ESA
Pin body	0.25 µm gold / 1.27 µm Ni	1.27 µm gold / 1.27 µm Ni (min)
Socket body	0.25 µm gold / 1.27 µm Ni on active area 1.27 µm Ni on non active area	0.25 µm gold / 1.27 µm Ni (min)
Socket wires	1 µm gold / 0.20 µm Ni	1.27 µm gold / 0.20 µm Ni (min)

Electrical

Current grade rating (at 25°C)	Standard grade: 3 A max - ESA grade: 5 A max
Dielectric withstanding voltage	1200 Vrms
Contact resistance	≤8 mΩ
Insulation resistance	>104 MΩ (500 Vcc)

Mechanical

Mating & unmating cycle	5000
Guiding	By two outside guides (2 guiding styles) and one central guide (3 guiding styles)
Keying	By rotating of outside polarized guides (up to 36 keying)

Environmental

Temperature range	-55°C to 125°C
Conformity	MIL C 55302, ESA/ESCC3401/016 - 3401/017, NF C-UTE C 93-424

How To Order



1 Series																																					
2 Pitch or type	N 1.27 mm pitch, rear removable contacts																																				
3 Model	C 3 rows centered fixing D 3 rows uncentered fixing																																				
4 Number of contacts	KNC 062 080 098 160 KND 026 044 062 080 098 108 126 144																																				
5 Molding polarity	<table border="1" style="width: 100%; border-collapse: collapse;"> <thead> <tr> <th style="width: 33%; text-align: left;">NF C-UTE C 93-424 MIL-C-55302 ESA/ESCC 3401/01601B SPACE GRADE</th> <th style="width: 33%; text-align: left;">NF C-UTE C 93-424 MIL-C-55302 ESA/ESCC 3401/01601B SPACE GRADE</th> <th style="width: 33%; text-align: left;">NF C-UTE C 93-424 MIL-C-55302 ESA/ESCC 3401/01601B SPACE GRADE</th> </tr> </thead> <tbody> <tr> <td>12 14 54 54 Female plug</td> <td>1A 1C - 5A Tinned female plug**</td> <td>26 28 - 46 Tinned female receptacle*</td> </tr> <tr> <td>13 15 55 55 Male plug</td> <td>1B 1D - 5B Tinned male plug**</td> <td>27 29 - 47 Tinned male receptacle*</td> </tr> <tr> <td>16 18 - 56 Tinned female plug*</td> <td>22 24 44 44 Female receptacle</td> <td>2A 2C - - Tinned female receptacle**</td> </tr> <tr> <td>17 19 - 57 Tinned male plug*</td> <td>23 25 45 45 Male receptacle</td> <td>2B 2D - - Tinned male receptacle**</td> </tr> </tbody> </table>	NF C-UTE C 93-424 MIL-C-55302 ESA/ESCC 3401/01601B SPACE GRADE	NF C-UTE C 93-424 MIL-C-55302 ESA/ESCC 3401/01601B SPACE GRADE	NF C-UTE C 93-424 MIL-C-55302 ESA/ESCC 3401/01601B SPACE GRADE	12 14 54 54 Female plug	1A 1C - 5A Tinned female plug**	26 28 - 46 Tinned female receptacle*	13 15 55 55 Male plug	1B 1D - 5B Tinned male plug**	27 29 - 47 Tinned male receptacle*	16 18 - 56 Tinned female plug*	22 24 44 44 Female receptacle	2A 2C - - Tinned female receptacle**	17 19 - 57 Tinned male plug*	23 25 45 45 Male receptacle	2B 2D - - Tinned male receptacle**																					
NF C-UTE C 93-424 MIL-C-55302 ESA/ESCC 3401/01601B SPACE GRADE	NF C-UTE C 93-424 MIL-C-55302 ESA/ESCC 3401/01601B SPACE GRADE	NF C-UTE C 93-424 MIL-C-55302 ESA/ESCC 3401/01601B SPACE GRADE																																			
12 14 54 54 Female plug	1A 1C - 5A Tinned female plug**	26 28 - 46 Tinned female receptacle*																																			
13 15 55 55 Male plug	1B 1D - 5B Tinned male plug**	27 29 - 47 Tinned male receptacle*																																			
16 18 - 56 Tinned female plug*	22 24 44 44 Female receptacle	2A 2C - - Tinned female receptacle**																																			
17 19 - 57 Tinned male plug*	23 25 45 45 Male receptacle	2B 2D - - Tinned male receptacle**																																			
6 Termination styles	<table border="1" style="width: 100%; border-collapse: collapse;"> <tbody> <tr> <td>10 Through board solder - 90° - length 3 mm</td> <td>21 Double crimp</td> <td>51 Wire wrap (3 wrapping levels)</td> </tr> <tr> <td>11 Through board solder - 90° - length 4 mm</td> <td>30 Through board solder - straight</td> <td>91 Female - male</td> </tr> <tr> <td>20 Crimp</td> <td>40 Solder bucket</td> <td></td> </tr> </tbody> </table>	10 Through board solder - 90° - length 3 mm	21 Double crimp	51 Wire wrap (3 wrapping levels)	11 Through board solder - 90° - length 4 mm	30 Through board solder - straight	91 Female - male	20 Crimp	40 Solder bucket																												
10 Through board solder - 90° - length 3 mm	21 Double crimp	51 Wire wrap (3 wrapping levels)																																			
11 Through board solder - 90° - length 4 mm	30 Through board solder - straight	91 Female - male																																			
20 Crimp	40 Solder bucket																																				
7 Mounting hardware	<p>Guide Style (consult us for special guides)</p> <table border="1" style="width: 100%; border-collapse: collapse;"> <tbody> <tr> <td>110 Male polarized, transverse mount, standard plug</td> <td>145 Male polarized, transverse mount on receptacle only</td> <td>131 Male unpolarized, transverse mount</td> </tr> <tr> <td>111 Male polarized, vertical mount</td> <td>190 Female power or mass contact, vertical mount</td> <td>132 Female unpolarized, transverse mount</td> </tr> <tr> <td>113 Male polarized, float mount</td> <td>125 Male unpolarized, transverse mount</td> <td>133 Female all polarized, transverse mount</td> </tr> <tr> <td>121 Female polarized, vertical mount</td> <td>126 Female unpolarized, vertical mount</td> <td>191 Male power or mass contact, vertical mount</td> </tr> <tr> <td>123 Female polarized, float mount</td> <td>127 Male unpolarized, vertical mount</td> <td></td> </tr> <tr> <td>124 Female polarized, transverse mount</td> <td>130 Female unpolarized, vertical mount</td> <td></td> </tr> </tbody> </table> <p>Locking Styles</p> <table border="1" style="width: 100%; border-collapse: collapse;"> <thead> <tr> <th style="width: 50%;">MALE PLUG</th> <th style="width: 50%;">FEMALE RECEPTACLE</th> </tr> </thead> <tbody> <tr> <td>201 1/4 turn, free connector</td> <td>202 1/4 turn, vertical mount</td> </tr> <tr> <td>203 1/4 turn, transverse mount</td> <td>204 1/4 turn, transverse mount</td> </tr> <tr> <td>207 Jackscrew, free connector</td> <td>208 Jackscrew, transverse mount</td> </tr> <tr> <td>211 Jackscrew, free connector</td> <td>210 Jackscrew, free connector</td> </tr> <tr> <td>290 Jackscrew, vertical mount</td> <td>212 Jackscrew, transverse mount</td> </tr> <tr> <td></td> <td>215 Jackscrew, vertical mount</td> </tr> <tr> <td></td> <td>219 Jackscrew, vertical mount</td> </tr> <tr> <td></td> <td>232 Jackscrew, with operation button</td> </tr> </tbody> </table>	110 Male polarized, transverse mount, standard plug	145 Male polarized, transverse mount on receptacle only	131 Male unpolarized, transverse mount	111 Male polarized, vertical mount	190 Female power or mass contact, vertical mount	132 Female unpolarized, transverse mount	113 Male polarized, float mount	125 Male unpolarized, transverse mount	133 Female all polarized, transverse mount	121 Female polarized, vertical mount	126 Female unpolarized, vertical mount	191 Male power or mass contact, vertical mount	123 Female polarized, float mount	127 Male unpolarized, vertical mount		124 Female polarized, transverse mount	130 Female unpolarized, vertical mount		MALE PLUG	FEMALE RECEPTACLE	201 1/4 turn, free connector	202 1/4 turn, vertical mount	203 1/4 turn, transverse mount	204 1/4 turn, transverse mount	207 Jackscrew, free connector	208 Jackscrew, transverse mount	211 Jackscrew, free connector	210 Jackscrew, free connector	290 Jackscrew, vertical mount	212 Jackscrew, transverse mount		215 Jackscrew, vertical mount		219 Jackscrew, vertical mount		232 Jackscrew, with operation button
110 Male polarized, transverse mount, standard plug	145 Male polarized, transverse mount on receptacle only	131 Male unpolarized, transverse mount																																			
111 Male polarized, vertical mount	190 Female power or mass contact, vertical mount	132 Female unpolarized, transverse mount																																			
113 Male polarized, float mount	125 Male unpolarized, transverse mount	133 Female all polarized, transverse mount																																			
121 Female polarized, vertical mount	126 Female unpolarized, vertical mount	191 Male power or mass contact, vertical mount																																			
123 Female polarized, float mount	127 Male unpolarized, vertical mount																																				
124 Female polarized, transverse mount	130 Female unpolarized, vertical mount																																				
MALE PLUG	FEMALE RECEPTACLE																																				
201 1/4 turn, free connector	202 1/4 turn, vertical mount																																				
203 1/4 turn, transverse mount	204 1/4 turn, transverse mount																																				
207 Jackscrew, free connector	208 Jackscrew, transverse mount																																				
211 Jackscrew, free connector	210 Jackscrew, free connector																																				
290 Jackscrew, vertical mount	212 Jackscrew, transverse mount																																				
	215 Jackscrew, vertical mount																																				
	219 Jackscrew, vertical mount																																				
	232 Jackscrew, with operation button																																				

* For 90° & straight terminations (splicing on PCB)
 ** RoHS compliant for 90° & straight terminations (splicing on PCB)

Hypertac & ESA Correspondence Table

HYPERTAC **KNC**

34 01 016 01 B

1

2

3

4

5

6

<p>1 ESCC component number</p>																																																																																														
<p>2 Mounting</p>	<table border="1"> <thead> <tr> <th colspan="4">HYPERTAC</th> <th colspan="4">ESA</th> </tr> </thead> <tbody> <tr> <td>Plug KNB 017</td><td>01</td> <td>Plug KNB 096</td><td>08</td> <td>Receptacle KNB 053</td><td>16</td> <td>Plug KNB 072</td><td>56</td> <td>Plug KNC 098</td><td>62</td> </tr> <tr> <td>Plug KNB 029</td><td>02</td> <td>Plug KNB 120</td><td>10</td> <td>Receptacle KNB 065</td><td>17</td> <td>Receptacle KNB 072</td><td>57</td> <td>Receptacle KNC 098</td><td>63</td> </tr> <tr> <td>Plug KNB 041</td><td>03</td> <td>Plug KNC 160</td><td>12</td> <td>Receptacle KNB 084</td><td>19</td> <td>Plug KNC 062</td><td>58</td> <td></td><td></td> </tr> <tr> <td>Plug KNB 053</td><td>04</td> <td>Receptacle KNB 017</td><td>13</td> <td>Receptacle KNB 096</td><td>20</td> <td>Receptacle KNC 062</td><td>59</td> <td></td><td></td> </tr> <tr> <td>Plug KNB 065</td><td>05</td> <td>Receptacle KNB 029</td><td>14</td> <td>Receptacle KNB 120</td><td>22</td> <td>Plug KNC 080</td><td>60</td> <td></td><td></td> </tr> <tr> <td>Plug KNB 084</td><td>07</td> <td>Receptacle KNB 041</td><td>15</td> <td>Receptacle KNC 160</td><td>24</td> <td>Receptacle KNC 080</td><td>61</td> <td></td><td></td> </tr> </tbody> </table> <table border="1"> <thead> <tr> <th colspan="4">REMINDER SPATIAL P.P.P. (Party Polarity Protection)</th> <th colspan="2">EXAMPLE</th> </tr> </thead> <tbody> <tr> <td>Female receptacle</td><td>44</td> <td>Plug female</td><td>54</td> <td colspan="2">KNC 062 44 30 113</td> </tr> <tr> <td>Male receptacle</td><td>45</td> <td>Plug male</td><td>55</td> <td colspan="2">P.P.P. </td> </tr> </tbody> </table>								HYPERTAC				ESA				Plug KNB 017	01	Plug KNB 096	08	Receptacle KNB 053	16	Plug KNB 072	56	Plug KNC 098	62	Plug KNB 029	02	Plug KNB 120	10	Receptacle KNB 065	17	Receptacle KNB 072	57	Receptacle KNC 098	63	Plug KNB 041	03	Plug KNC 160	12	Receptacle KNB 084	19	Plug KNC 062	58			Plug KNB 053	04	Receptacle KNB 017	13	Receptacle KNB 096	20	Receptacle KNC 062	59			Plug KNB 065	05	Receptacle KNB 029	14	Receptacle KNB 120	22	Plug KNC 080	60			Plug KNB 084	07	Receptacle KNB 041	15	Receptacle KNC 160	24	Receptacle KNC 080	61			REMINDER SPATIAL P.P.P. (Party Polarity Protection)				EXAMPLE		Female receptacle	44	Plug female	54	KNC 062 44 30 113		Male receptacle	45	Plug male	55	P.P.P.	
HYPERTAC				ESA																																																																																										
Plug KNB 017	01	Plug KNB 096	08	Receptacle KNB 053	16	Plug KNB 072	56	Plug KNC 098	62																																																																																					
Plug KNB 029	02	Plug KNB 120	10	Receptacle KNB 065	17	Receptacle KNB 072	57	Receptacle KNC 098	63																																																																																					
Plug KNB 041	03	Plug KNC 160	12	Receptacle KNB 084	19	Plug KNC 062	58																																																																																							
Plug KNB 053	04	Receptacle KNB 017	13	Receptacle KNB 096	20	Receptacle KNC 062	59																																																																																							
Plug KNB 065	05	Receptacle KNB 029	14	Receptacle KNB 120	22	Plug KNC 080	60																																																																																							
Plug KNB 084	07	Receptacle KNB 041	15	Receptacle KNC 160	24	Receptacle KNC 080	61																																																																																							
REMINDER SPATIAL P.P.P. (Party Polarity Protection)				EXAMPLE																																																																																										
Female receptacle	44	Plug female	54	KNC 062 44 30 113																																																																																										
Male receptacle	45	Plug male	55	P.P.P.																																																																																										
<p>3 Termination style</p>	<table border="1"> <thead> <tr> <th colspan="4">HYPERTAC</th> <th colspan="4">ESA</th> </tr> </thead> <tbody> <tr> <td>Bent male 10</td><td>MC</td> <td>Solder bucket male 40</td><td>MS</td> <td>Crimp female 20</td><td>FR</td> <td colspan="2">Female-male 91</td><td>FM</td> </tr> <tr> <td>Bent long male 11</td><td>ML</td> <td>Mini-wrapping male 51</td><td>MY</td> <td>Straight female 30</td><td>FD</td> <td colspan="3"></td> </tr> <tr> <td>Crimp male 20</td><td>MR</td> <td>Bent female 10</td><td>FC</td> <td>Solder bucket female 40</td><td>FS</td> <td colspan="3"></td> </tr> <tr> <td>Straight male 30</td><td>MD</td> <td>Bent long female 11</td><td>FL</td> <td>Mini-wrapping female 51</td><td>FY</td> <td colspan="3"></td> </tr> </tbody> </table>								HYPERTAC				ESA				Bent male 10	MC	Solder bucket male 40	MS	Crimp female 20	FR	Female-male 91		FM	Bent long male 11	ML	Mini-wrapping male 51	MY	Straight female 30	FD				Crimp male 20	MR	Bent female 10	FC	Solder bucket female 40	FS				Straight male 30	MD	Bent long female 11	FL	Mini-wrapping female 51	FY																																													
HYPERTAC				ESA																																																																																										
Bent male 10	MC	Solder bucket male 40	MS	Crimp female 20	FR	Female-male 91		FM																																																																																						
Bent long male 11	ML	Mini-wrapping male 51	MY	Straight female 30	FD																																																																																									
Crimp male 20	MR	Bent female 10	FC	Solder bucket female 40	FS																																																																																									
Straight male 30	MD	Bent long female 11	FL	Mini-wrapping female 51	FY																																																																																									
<p>4 Locking type On left side</p>	<table border="1"> <thead> <tr> <th colspan="4">HYPERTAC</th> <th colspan="4">ESA</th> </tr> </thead> <tbody> <tr> <td>Guideless connector</td><td>00</td> <td>KNB 145</td><td>40</td> <td>KNC 10 209</td><td>49</td> <td>KNB 11 125</td><td>71</td> <td>KNB 11 208</td><td>79</td> </tr> <tr> <td>KNB 131</td><td>31</td> <td>KNB 124</td><td>41</td> <td>KN 210</td><td>50</td> <td>KNB 11 110</td><td>72</td> <td>KN 219</td><td>80</td> </tr> <tr> <td>KNB 132</td><td>32</td> <td>KNC 10 230</td><td>43</td> <td>KN 211</td><td>51</td> <td>KNB 10 230</td><td>73</td> <td>KN 290*</td><td>81</td> </tr> <tr> <td>KNB 10 110</td><td>33</td> <td>KN 232</td><td>45</td> <td>KNB 212</td><td>52</td> <td>KNC 124</td><td>74</td> <td></td><td></td> </tr> <tr> <td>KNC 10 110</td><td>34</td> <td>KN 231</td><td>46</td> <td>KN 215</td><td>53</td> <td>KNC 132</td><td>75</td> <td></td><td></td> </tr> <tr> <td>KN 111</td><td>35</td> <td>KN 207</td><td>47</td> <td>KN 123</td><td>54</td> <td>KNC 11 110</td><td>76</td> <td></td><td></td> </tr> <tr> <td>KN 121</td><td>36</td> <td>KNB 10 208</td><td>48</td> <td>KN 113</td><td>55</td> <td>KNC 11 125</td><td>77</td> <td></td><td></td> </tr> </tbody> </table>								HYPERTAC				ESA				Guideless connector	00	KNB 145	40	KNC 10 209	49	KNB 11 125	71	KNB 11 208	79	KNB 131	31	KNB 124	41	KN 210	50	KNB 11 110	72	KN 219	80	KNB 132	32	KNC 10 230	43	KN 211	51	KNB 10 230	73	KN 290*	81	KNB 10 110	33	KN 232	45	KNB 212	52	KNC 124	74			KNC 10 110	34	KN 231	46	KN 215	53	KNC 132	75			KN 111	35	KN 207	47	KN 123	54	KNC 11 110	76			KN 121	36	KNB 10 208	48	KN 113	55	KNC 11 125	77										
HYPERTAC				ESA																																																																																										
Guideless connector	00	KNB 145	40	KNC 10 209	49	KNB 11 125	71	KNB 11 208	79																																																																																					
KNB 131	31	KNB 124	41	KN 210	50	KNB 11 110	72	KN 219	80																																																																																					
KNB 132	32	KNC 10 230	43	KN 211	51	KNB 10 230	73	KN 290*	81																																																																																					
KNB 10 110	33	KN 232	45	KNB 212	52	KNC 124	74																																																																																							
KNC 10 110	34	KN 231	46	KN 215	53	KNC 132	75																																																																																							
KN 111	35	KN 207	47	KN 123	54	KNC 11 110	76																																																																																							
KN 121	36	KNB 10 208	48	KN 113	55	KNC 11 125	77																																																																																							
<p>5 Locking type In center</p>	<p>00 For 2 guide connectors</p> <p>-- For 3 guide connectors (see table 4, Locking type - On left side)</p> <table border="1"> <thead> <tr> <th colspan="4">HYPERTAC</th> <th colspan="4">ESA</th> </tr> </thead> <tbody> <tr> <td>KNB 10 125</td><td>26</td> <td>KNC 10 125</td><td>27</td> <td>KN 127</td><td>28</td> <td>KN 126</td><td>29</td> <td colspan="2"></td> </tr> </tbody> </table>								HYPERTAC				ESA				KNB 10 125	26	KNC 10 125	27	KN 127	28	KN 126	29																																																																						
HYPERTAC				ESA																																																																																										
KNB 10 125	26	KNC 10 125	27	KN 127	28	KN 126	29																																																																																							
<p>6 Locking type On right side</p>	<p>(see table 4, Locking type - On left side)</p>																																																																																													

* Please consult us

Contact Terminations

Plug

Receptacle

Male

Female

Female

Male

90° Through board solder

Ref: **10** (X=3) Ref : **MC & FC** - Ref: **11** (X=4) Ref : **ML & FL**

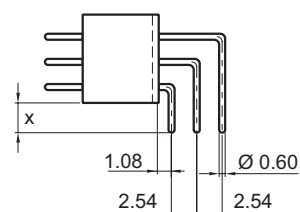
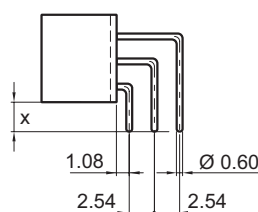
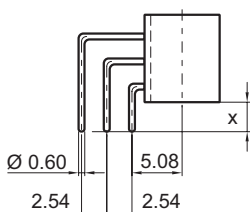
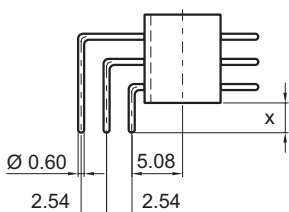

Crimp (AWG 28-22)

Ref: **20** Ref : **MR & FR**

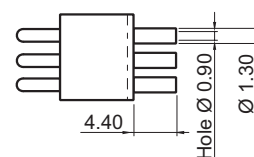
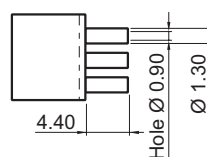
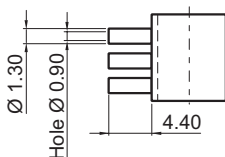
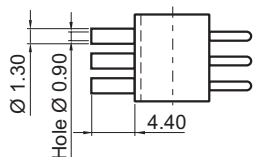

Crimp (AWG 28-22)

Ref: **21**

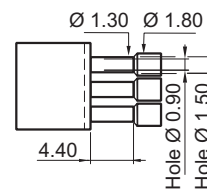
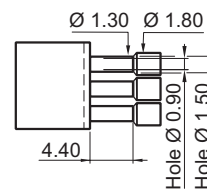
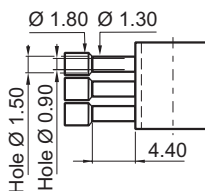
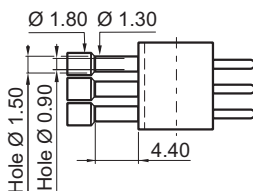

Straight through board solder

Ref: **30** Ref : **MD & FD**

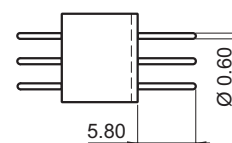
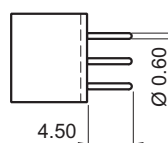
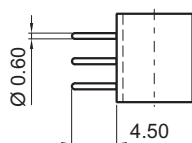
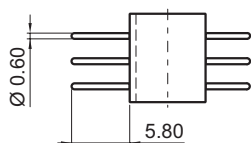

Contact Terminations

Plug

Receptacle

Male

Female

Female

Male

Solder bucket (AWG 22 max)

Ref: **40** Ref: **MS & FS**

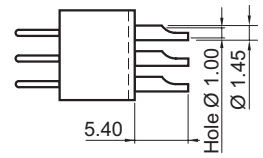
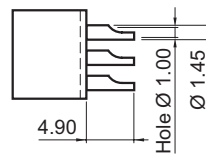
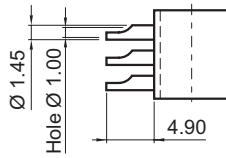
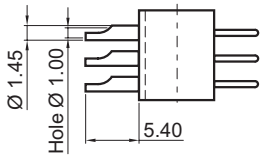

Wire wrap (3 wrapping levels)

Ref: **51** Ref: **MY & FY**

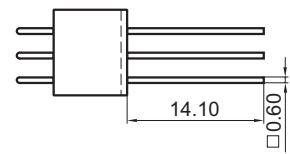
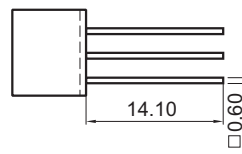
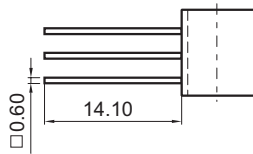
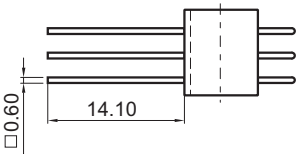

Saver (male-male)

Ref: **90**

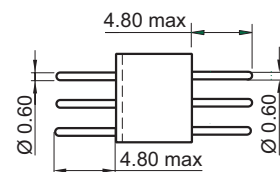
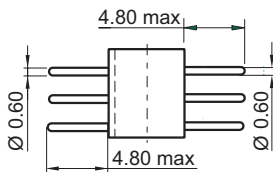

Saver (female-male)

Ref: **91** Ref: **FM**

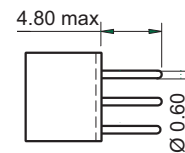
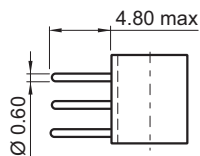

Dimensions

Plug

Receptacle

26 to 98 contacts

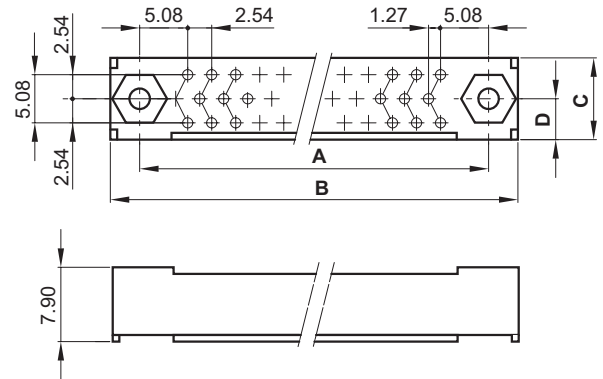
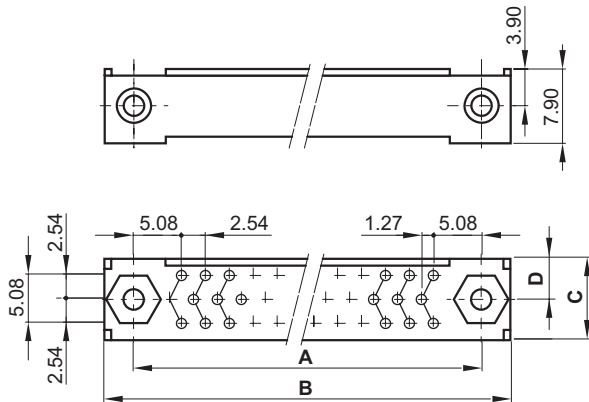

108 to 160 contacts

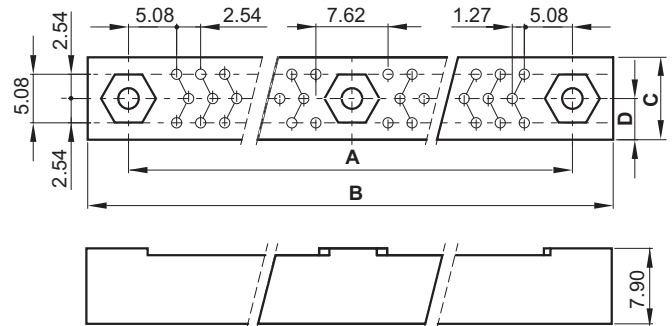
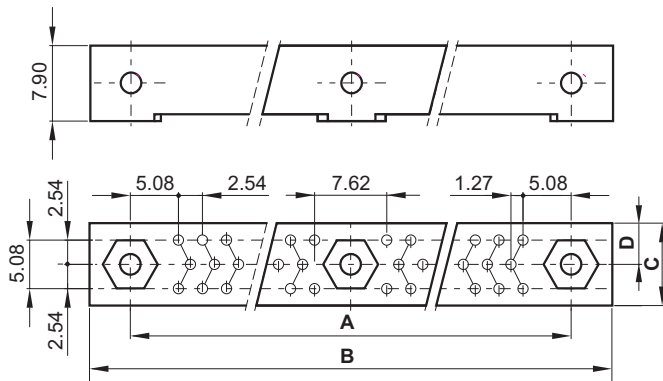

		No. of contacts	26	44	62	80	98	108	126	144	160
KNC	Plug & Receptacle	A	-	-	60.96	76.20	91.44	-	-	-	149.86
		B max	-	-	69.00	84.20	99.50	-	-	-	158.00
	Plug	C max	-	-	9.45	9.45	9.45	-	-	-	9.30
		D	-	-	4.42	4.42	4.42	-	-	-	4.70
	Receptacle	C max	-	-	9.30	9.30	9.30	-	-	-	9.30
		D	-	-	4.17	4.17	4.17	-	-	-	4.70
KND	Plug & Receptacle	A	30.48	45.72	60.96	76.20	91.44	106.68	121.92	137.16	-
		B max	38.50	53.70	69.00	84.20	99.50	114.70	129.90	145.20	-
	Plug	C min	8.95	8.95	8.95	8.95	8.95	8.95	8.95	8.95	-
		C max	9.55	9.55	9.55	9.55	9.55	9.55	9.55	9.55	-
		D	3.15	3.15	3.15	3.15	3.15	3.15	3.15	3.15	-
	Receptacle	C max	9.35	9.35	9.35	9.35	9.35	9.35	9.35	9.35	-
		D	3.10	3.10	3.10	3.10	3.10	3.10	3.10	3.10	-

Guide Styles

Plug & Receptacle

Male

Polarized vertical mount

Ref: **111** Ref : **35**

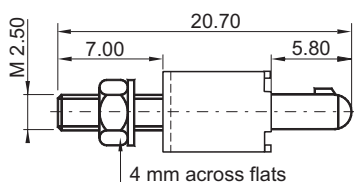

Female

Polarized vertical float mount

Ref: **123** Ref : **54**

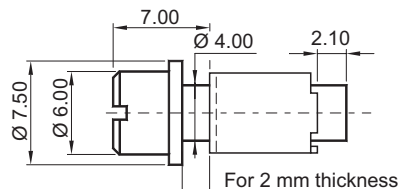

Polarized vertical float mount

Ref: **113** Ref : **55**

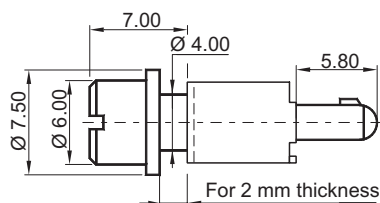

Polarized transverse mount

Ref: **124** Ref : **74**

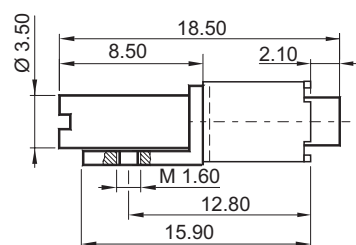

Unpolarized vertical mount

Ref: **127** Ref : **28**

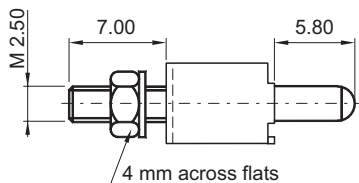

Unpolarized vertical mount

Ref: **126** Ref : **29**

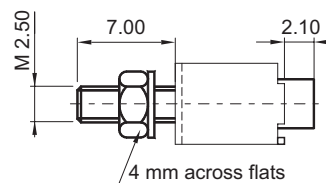

Unpolarized transverse mount

Ref: **131**

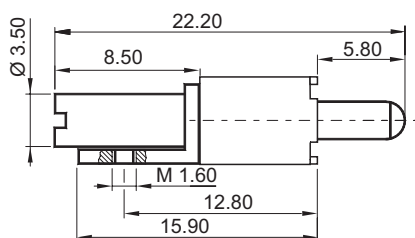

All polarized vertical mount

Ref: **130**

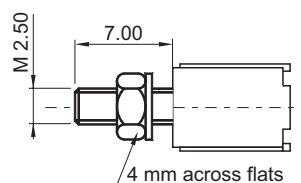

Guide Styles

Plug & Receptacle

Male

Polarized transverse mount

Ref: **145**

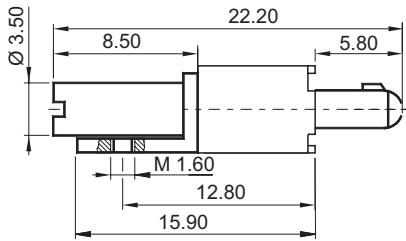

Female

Unpolarized transverse mount

Ref: **132** Ref: **75**

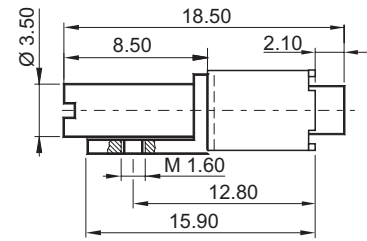

Polarized vertical mount

Ref: **121** Ref: **36**

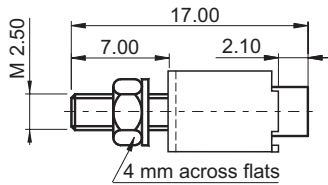

All polarized transverse mount

Ref: **133**

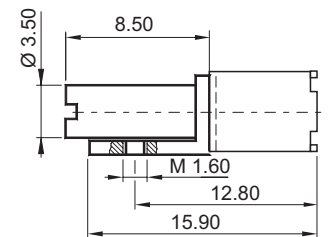

Guide Styles

Plug & Receptacle

Male

Power or mass vertical mount

Ref: **191** PCB thickness **1.60**

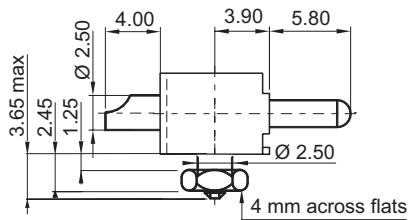

Female

Power or mass vertical mount

Ref: **190**

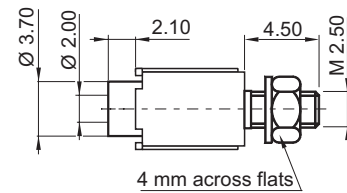

Male plug only

Polarized transverse mount

Ref: **10 110** Ref : **34** PCB thickness **1.60**

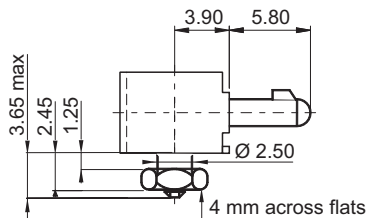

Unpolarized transverse mount

Ref: **10 125** Ref : **27** PCB thickness **1.60**

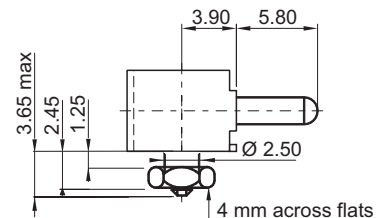

Locking Devices Compatibility Chart

		R	P	R	P	R	P	R	P	R	P	R	P	R	P
Compatible															
												Receptacle	Molding		
												Plug			
P															
R															
P															
R															
P															
R															
P															
R															
P															
R															
P															
R															
												Male locking devices			
												Female locking devices			
Receptacle															
Plug															
Molding															
		232	219	215	212	210	208	204	202						

Male Locking Styles

Plug & Receptacle

Jack 1/4 turn lock, free connector

Ref: **201**

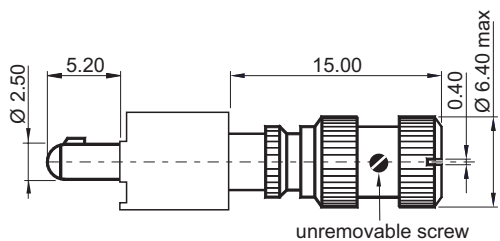

Jackscrew, free connector

Ref: **211** Ref : **51**

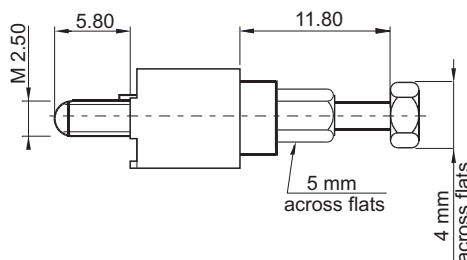

Jack 1/4 turn lock, transverse mount

Ref: **206**

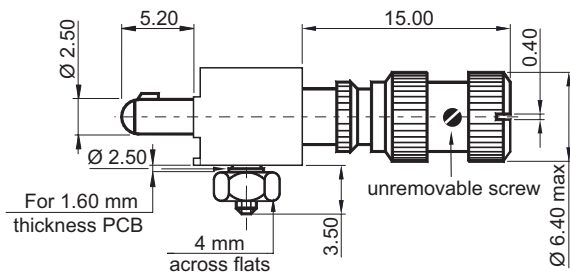

Jackscrew, vertical mount

Ref: **231** Ref : **46**

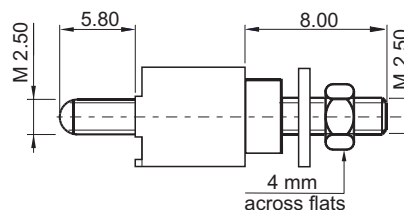

Jackscrew, free connector

Ref: **207** Ref : **47**

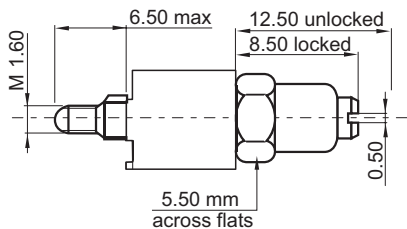

Jackscrew, vertical mount

Ref: **290** Ref : **81**

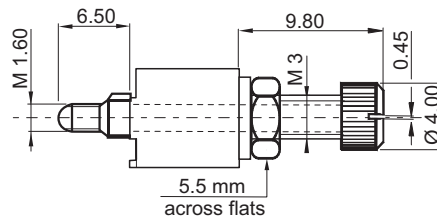

Female Locking Styles

Plug & Receptacle

Jack 1/4 turn lock, vertical mount

Ref: **202**

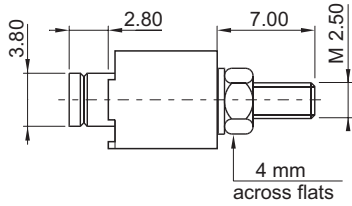

Jackscrew, transverse mount

Ref: **212**

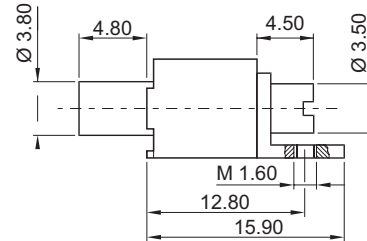

Jackscrew, transverse mount

Ref: **10 209** Ref: **49** PCB thickness 1.60

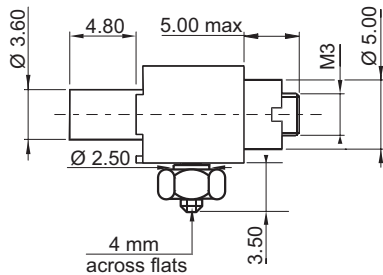

Jackscrew, vertical mount

Ref: **215** Ref: **53**

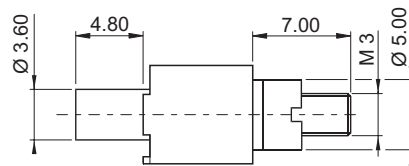

Jackscrew, free connector

Ref: **210** Ref: **50**

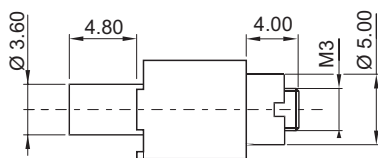

Jackscrew, vertical mount

Ref: **219** Ref: **80**

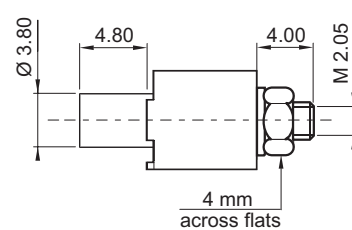

Rotating jackscrew

Ref: **232**

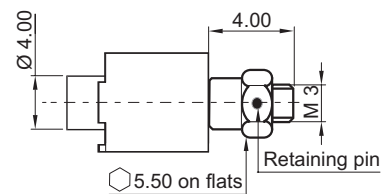

Receptacle Mating Side Layout View

26 to 98 contacts

108 to 160 contacts

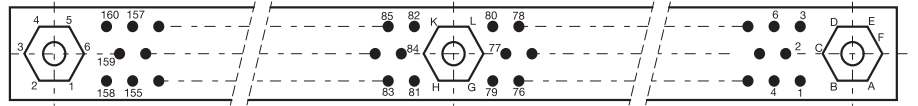
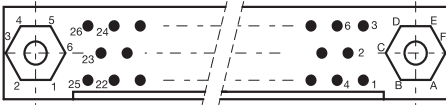

Panel Preparation Details

26 to 98 contacts

108 to 160 contacts

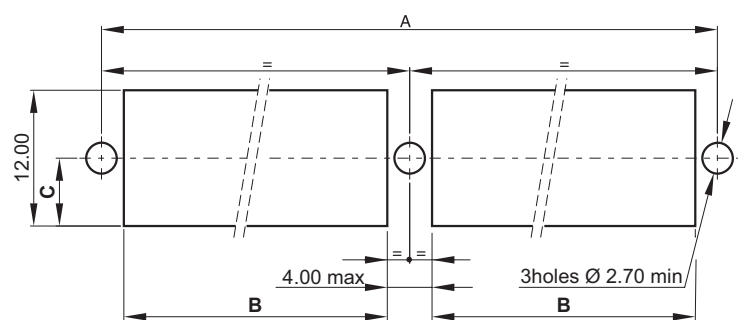
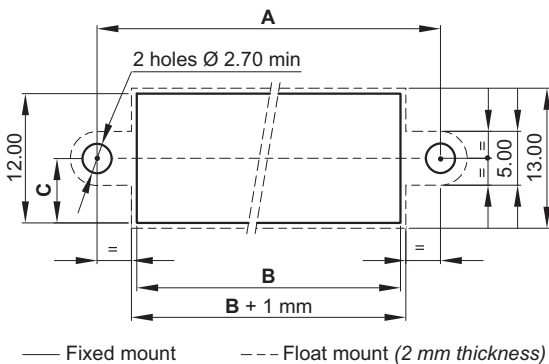

Panel: female or male, plug or receptacle

Terminations: 40 - 51

Guide styles: 111 - 121 (*Fixed Mount*)

Guide styles: 113 - 123 - 202 (*Float Mount*)

No. of contacts	26	44	62	80	98	108	126	144	160
A	30.48	45.72	60.96	76.20	91.44	106.68	121.92	137.16	149.86
B min	25.90	41.10	56.40	71.60	86.90	48.50	56.00	63.60	69.95
C (KNC)	-	-	6.00	6.00	6.00	-	-	-	6.00
C (KND)	4.73	4.73	4.73	4.73	4.73	4.73	4.73	4.73	-

Board Preparation Details

Mother board

26 to 98 Contacts

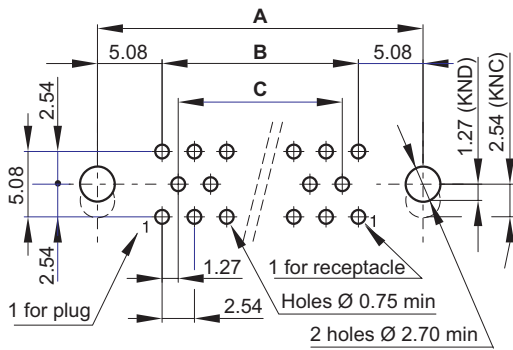

108 to 160 Contacts

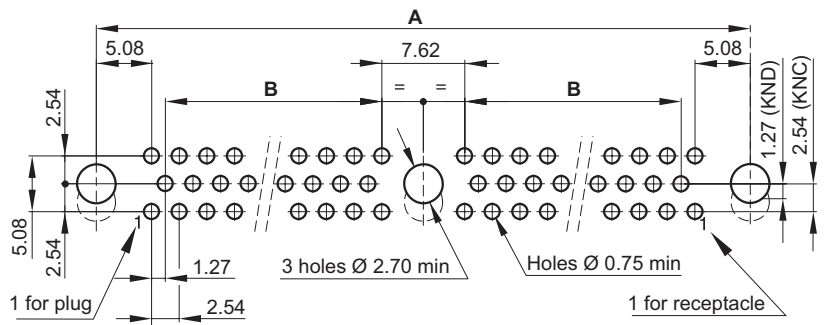

Mother Board: female or male, plug or receptacle, straight solder termination
Guide styles: 111 - 121- 202

Daughter board

26 to 98 Contacts

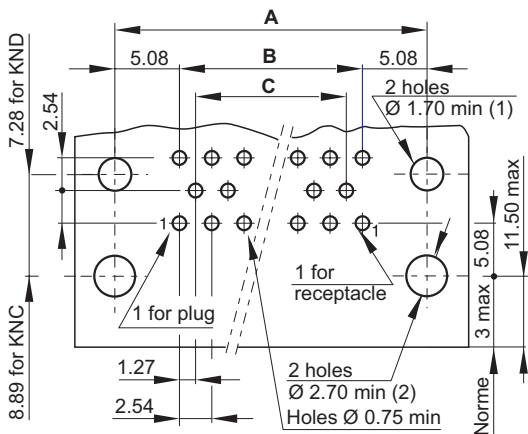

108 to 160 Contacts

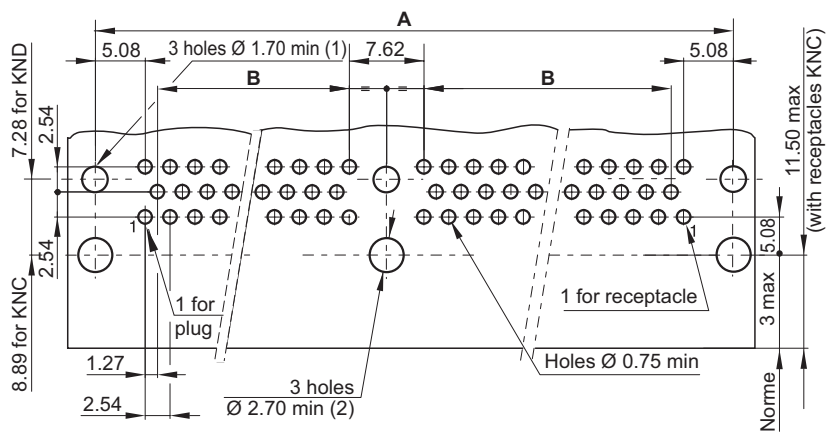

Daughter Board: female or male, plug or receptacle, 90° termination
 (1) **Guide styles:** 124 (2) **Guide styles:** 110 - 206

No. of contacts	26	44	62	80	98	108	126	144	160
A	30.48	45.72	60.96	76.20	91.44	106.68	121.92	137.16	149.86
B	20.32	35.56	50.80	66.04	81.28	43.18	50.80	58.42	64.77
C	17.78	33.02	48.26	63.50	78.74	-	-	-	-

Contacts

Male

Crimp terminations AWG 22-28 (0.079 - 0.34 mm²)

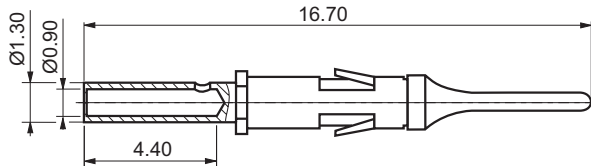

Reference	Part number
KN- ---13 20 ---	006 042 1- 20R OG
KN- ---55 20 --- MR	006 042 1- 20P OF 3401 017 004B

Female

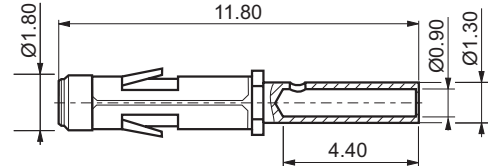

Reference	Part number
KN- ---22 20 ---	006 042 2- 20R GO
KN- ---44 20 --- FR	006 042 2- 20P J9 3401 017 015B

Crimp terminations AWG 22-28 (0.079 - 0.34 mm²) & Sheath Ø1.45

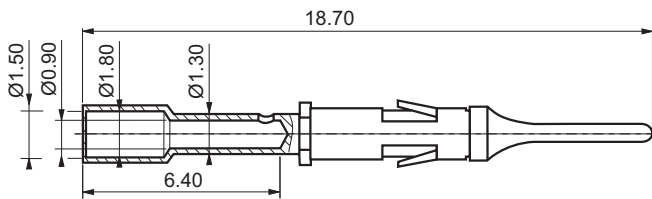

Reference	Part number
KN- ---13 20 ---	006 063 1- 21R OG
KN- ---55 20 ---	006 063 1- 20R OF

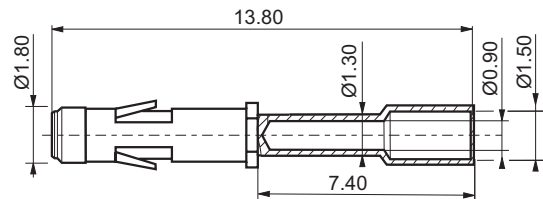

Reference	Part number
KN- ---22 20 ---	006 063 2- 21R GO
KN- ---44 20 ---	006 063 2- 21R J3

Tools and accessories

Crimp tool & Positioner



Ref: S_102
(M22520/2.01)



Contact part number	Crimp tool	AWG	Wire cross section	Positioner	Tool turret	Selector position
006 042 1- 20R OG 006 042 2- 20R GO	ASTRO TOOL M22520/2.01	28	0.079	SS-0060000001		3
		26	0.14			4
		24	0.20			4
		22	0.34			5
	DANIELS M22520/2.01	28	0.079	SS-0060000001		3
		26	0.14			4
		24	0.20			4
		22	0.34			5

006 063 1- 21R OG 006 063 2- 21R GO	2 operations	ASTRO TOOL M22520/2.01	28	0.079	SS-0060000001		3	
			26	0.14			4	
			24	0.20			4	
			22	0.34			5	
		1 st crimp (lead)	DANIELS M22520/2.01	28	0.079	SS-0060000001		3
				26	0.14			4
				24	0.20			4
				22	0.34			5
	2 nd crimp (sheath)	ASTRO TOOL M22520/2.01	28	0.079	SS-0060000002		*	
			26	0.14			6	
			24	0.20			7	
			22	0.34			7	
		DANIELS M22520/2.01	28	0.079	SS-0060000002		*	
			26	0.14			6	
			24	0.20			7	
			22	0.34			7	

	1 operation	52007	28	0.079		SP717	2
			26	0.14			3
			24	0.20			4
			22	0.34			4

Insertion

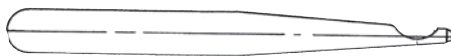

SM-0060000001

Extraction

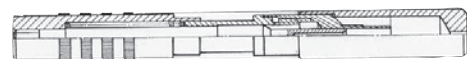

SD-0060000006

Alignment Combs

for 90° through board termination

2 fixing points
3 fixing points

HPF107/B
SP. 006 00 00 004

Screwdriver for m3 nut

208 locking devices
215 locking devices

S_075

Accessories

Antistatic Pin Protector

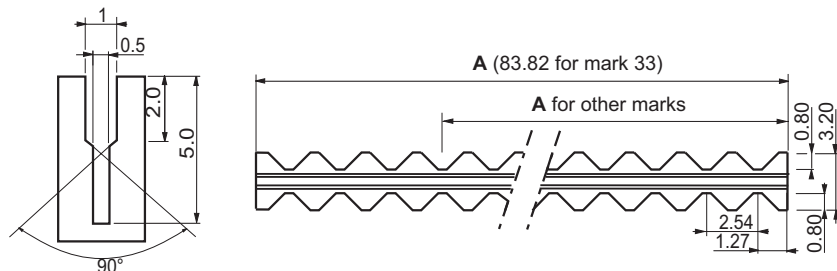

Ordering information
KNB - - - - 314
 ↑
 Ref

Use	A	Ref	Use	A	Ref
KNB 017	24.13	009	KNB 096	62.23	024
KND 026			KND 144		
KNB 029 KND 044	39.37	015	KNB 053	69.85	027
			KNC 080 & 160		
			KND 080		
KNB 072 KND 108	46.99	018	KNB 120	77.47	030
KNB 041 & 084	54.61	021	KNB 065	83.82	033
KNC 062			KNC 098		
KND 062 & 126			KND 098		

Note: Each part number contains only one header.
 To equip fully the connector, you have to order 2, 3, 4 or 6 identical headers.
 Header can fit on contacts or be positioned between rows.

Accessories

Pin Protector (*extruded polypropylene*)

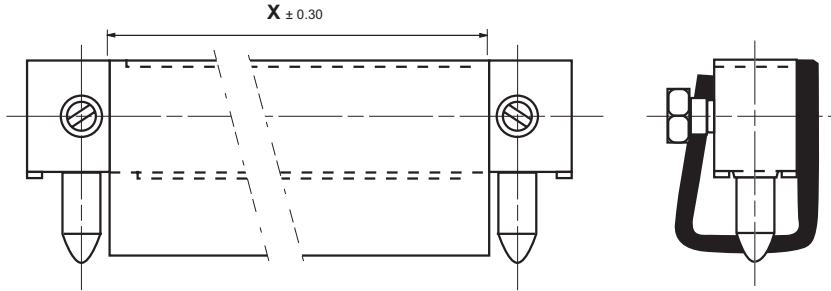

Ordering information

K N - - - - 308
 B, C or D Number of positions

KNB	017	029	041	053	065	072	084	096	120
X ± 0.30	25.50	40.70	56	71.20	86.50	48.40	56	63.60	78.80
Qty	1	1	1	1	1	2	2	2	2

KNC	062	080	098	119	160
X ± 0.30	66	81.20	96.40	114.20	155.00
Qty	1	1	1	1	1

KND	026	044	108	126	144
X ± 0.30	35.50	50.70	111.70	127.00	142.20
Qty	1	1	1	1	1

Disclaimer

All of the information included in this catalogue is believed to be accurate at the time of printing. It is recommended, however, that users should independently evaluate the suitability of each product for their intended application and be sure that each product is properly installed, used and maintained to achieve desired results.

Smiths Interconnect makes no warranties as to the accuracy or completeness of the information, and disclaims any liability regarding its use.

Smiths Interconnect reserves the right to modify design and specifications, in order to improve quality, keep pace with technological development or meet specific production requirements.

No reproduction or use without express permission of editorial and pictorial content, in any manner.

Product Portfolio

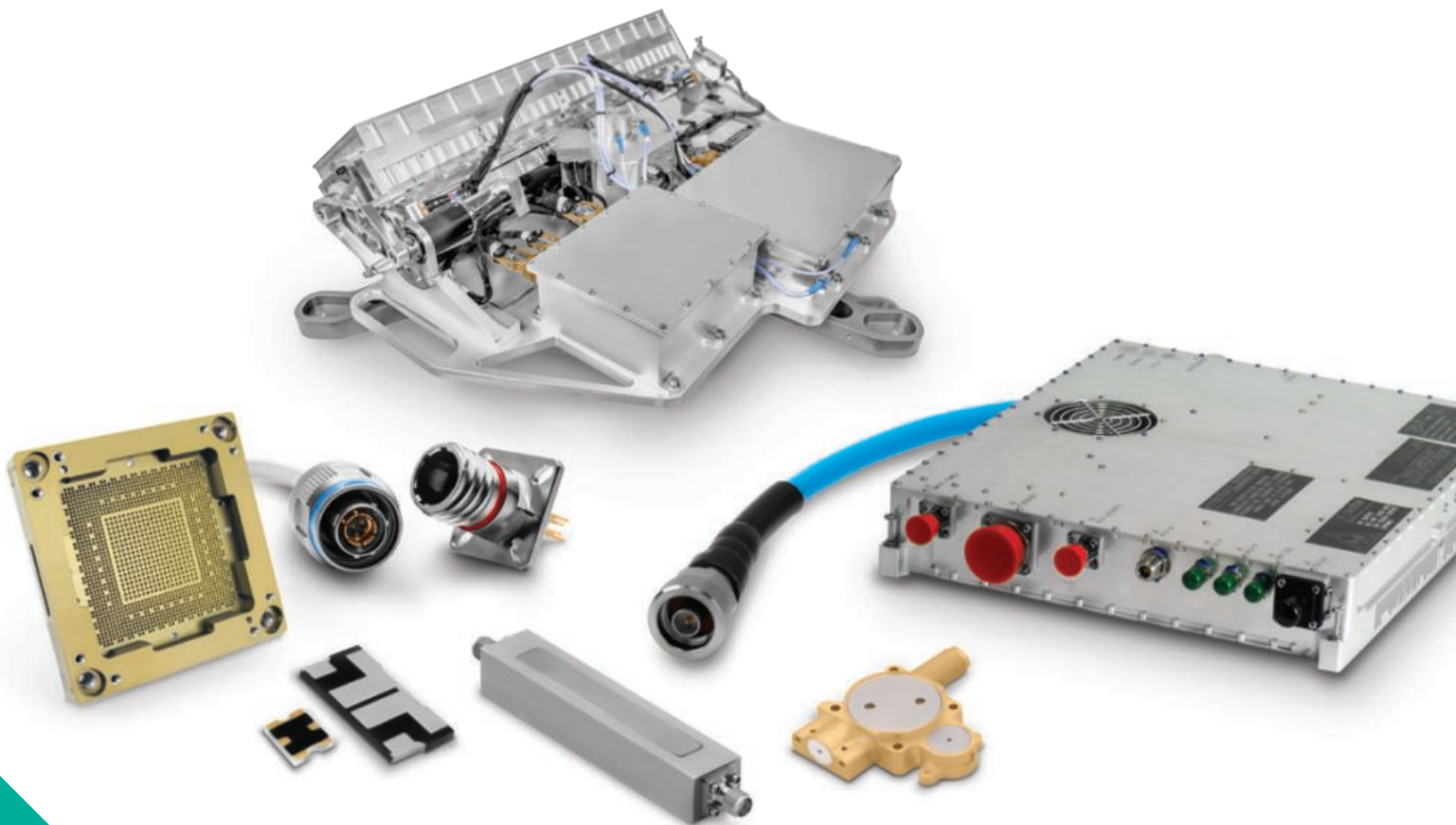

- Antenna Systems
- Cable Assemblies
- Connector Solutions
- Ferrite Components & Assemblies
- RF Filter Components & Assemblies
- Integrated Microwave Assemblies
- Millimeter-Wave Solutions
- RF Components
- Test Sockets and WLCSP Probe Heads
- Time & Frequency Systems

Worldwide Support

Connectors

Americas

Sales

connectors.uscsr@smithsinterconnect.com

Technical Support

connectors.ustechsupport@smithsinterconnect.com

Europe

Sales

connectors.emeacsr@smithsinterconnect.com

Technical Support

connectors.emeatechsupport@smithsinterconnect.com

Asia

Sales

asiacsr@smithsinterconnect.com

Technical Support

asiatechsupport@smithsinterconnect.com

Fiber Optics & RF Components

Americas

Sales

focom.uscsr@smithsinterconnect.com

Technical Support

focom.techsupport@smithsinterconnect.com

Europe

Sales

focom.emeacsr@smithsinterconnect.com

Technical Support

focom.techsupport@smithsinterconnect.com

Asia

Sales

focom.asiacsr@smithsinterconnect.com

Technical Support

focom.techsupport@smithsinterconnect.com

Semiconductor Test

Americas

Sales

semi.uscsr@smithsinterconnect.com

Technical Support

semi.techsupport@smithsinterconnect.com

Europe

Sales

semi.emeacsr@smithsinterconnect.com

Technical Support

semi.techsupport@smithsinterconnect.com

Asia

Sales

semi.asiacsr@smithsinterconnect.com

Technical Support

semi.techsupport@smithsinterconnect.com

RF/MW Subsystems

Americas, Europe & Asia

Sales

subsystems.csr@smithsinterconnect.com

Technical Support

subsystems.techsupport@smithsinterconnect.com

Connecting Global Markets