

TS06 Series

ATTENUATOR CHIP DC-20GHZ

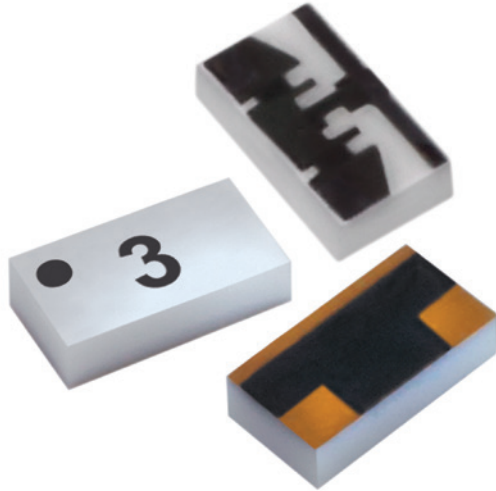

Smiths Interconnect is the world leader in chip attenuators offering the widest selection of products from DC through Q band. Chip components are offered on Alumina, Aluminum Nitride, Beryllium Oxide, and CVD Diamond for a wide range of applications. Backed by proven performance and significant heritage, Smiths Interconnect is the leader in high reliability components.

The TS06 platform offers best in class performance from DC-20 GHz in a small package size. Rated for DC-20 GHz with excellent broadband response, the TS06 series of products has a wide range of applications. It is constructed on an Alumina substrate with rugged thin film terminations and passivated Tantalum Nitride resistive elements. The product also includes a protective coating for added protection from various environmental conditions. Multiple attenuation values and surface finishes are available for RoHS and tin lead solder applications.

TS06 Series Chip Attenuators offers best in class performance from DC-20 GHz in a small package size.

Features and Benefits

- Small Footprint
- Multiple Terminal Finishes
- Broad Frequency Range
- Low VSWR
- Wide Range of Attenuation Values
- Tight Attenuation Tolerance

Applications

- Amplifier Circuits
- Transmit/Receive Modules
- Up/Down Converters
- Instrumentation
- Satellite Communications
- Radar
- Broadcast

Technical Characteristics

Mounting Configuration Options	Planar
--------------------------------	--------

Electrical

Nominal Impedance	50 ohms					
Frequency Range	DC -20 GHz					
Attenuation Values Available	0-12, 15 & 20 dB in 1 dB Increments					
Attenuation Accuracy	ATTENUATION ACCURACY (dB)					
	Attenuation Value (dB)	DC-10 GHz		10-20 GHz		
	0	Continuity Only				
	1-9	± 0.50		± 0.50		
	10-20	± 0.75		± 1.00		
Input Power CW	INPUT POWER (CW)					
	dB	Watts	dB	Watts	dB	Watts
	0-1	3.0	2-3	1.0	4-20	0.5
Peak Power	10X CW power based on 1 µs pulse width @ 1% Duty Cycle					
VSWR	DC-10GHz 1.25:1 Max, 10-20GHz 1.35:1 Max					

Environmental

Operating Temperature	-55°C to +150°C
Storage Temperature	-65°C to +150°C
Temperature Coefficient	± 200 PPM/°C Max
Moisture Sensitivity Level	MSL 1 - Unlimited

Mechanical

Substrate Material	Alumina (Al ₂ O ₃) 96%
Resistive Film	Thin Film, Tantalum Nitride
Terminal Material	Thin Film, Solderable Gold over Nickel
Protective Coating	Silicon Nitride
Finish Options	Blank
	-F
	-S
	Solder Plated (Sn60/Pb40)
	Silver Plated (RoHS Compliant)
	Pretinned (Sn60/Pb40)

Marking

Unit Marking	Orientation dot and dB Value
--------------	------------------------------

Quality Assurance

	Sample visual and mechanical inspection - 1.0 AQL per mechanical drawing requirements. Periodic electrical inspection performed for commercial grade products. High reliability tested products are available per MIL-PRF-55342.
--	----------------------------------------------------------------------------------------------------------------------------------------------------------------------------------------------------------------------------------------

Packaging

Standard Packaging	Tape and Reel or Waffle Pack
--------------------	------------------------------

Power Derating Curve

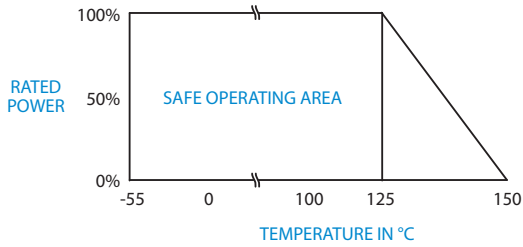

Typical Data

TS06XX Series Attenuation

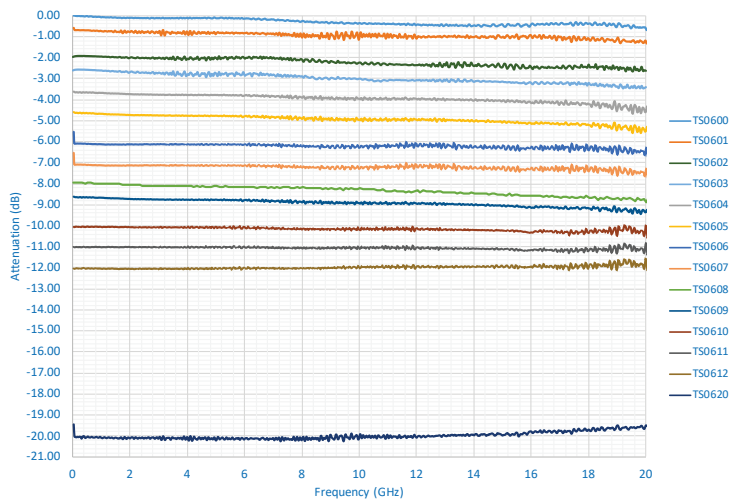

Mechanical

TS06XX - Planar Option

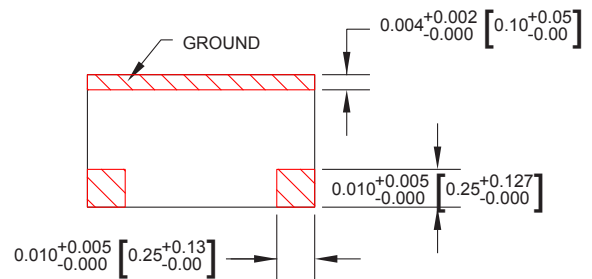
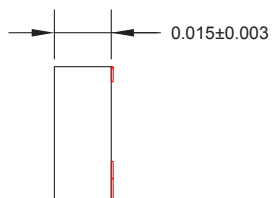
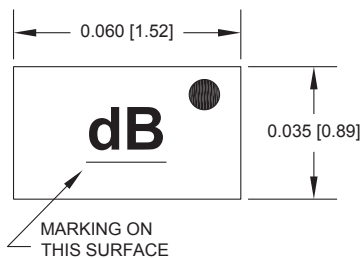

Unless otherwise specified, tolerance: X.XXX = ±0.005"

Suggested Mounting Footprint

Part Number	Inches						Millimeters					
	A	B	C	D	S	W	A	B	C	D	S	W
TS06xxF	0.018	0.018	0.033	0.020	0.016	0.068	0.46	0.46	0.84	0.51	0.41	1.73

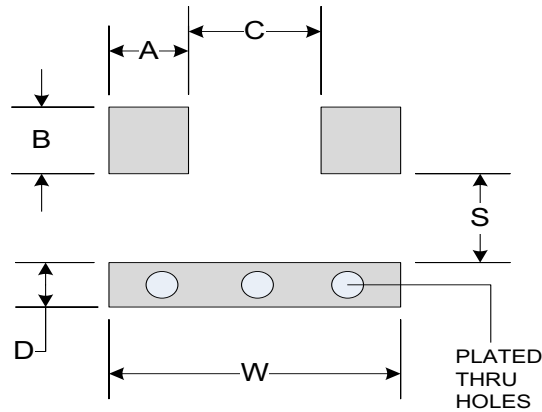

How To Order

Specify Model Number: **TS06XXX**

	T S O 6				
	1		2		3
1 Series Name	T S O 6 Series				
2 Attenuation Value	0 0 00 dB through 12.0 dB	1 5 15.0 dB	2 0 20.0 dB		
3 Terminal Finish	Standard	S Pretinning	F RoHS		

Global Support

Americas

- Costa Mesa, CA
+1 714 371 1100
info.us@smithsinterconnect.com
- Milpitas, CA
+1 408 957 9607 x-1125
info.us@smithsinterconnect.com
- Stuart, FL
+1 772 286 9300
info.us@smithsinterconnect.com
- Kirkland, QC, Canada
+1 514 842 5179
info.us@smithsinterconnect.com
- Hudson, MA
+1 978 568 0451
info.us@smithsinterconnect.com
- Northampton, MA
+1 413 582 9620
info.northampton@smithsinterconnectinc.com
- Tampa, FL
+ 1 813 901 7200
info.tampa@smithsinterconnectinc.com
- Kansas City, KS
+1 913 342 5544
info.us@smithsinterconnect.com
- Salisbury, MD
+1 800 780 2169
info.us@smithsinterconnect.com
- Thousand Oaks, CA
+1 805 267 0100
info.thousandoaks@smithsinterconnectinc.com

Europe

- Deggendorf, Germany
+49 991 250 120
info.de@smithsinterconnect.com
- Genova, Italy
+39 0 10 60361
info.it@smithsinterconnect.com
- Dundee, UK
+44 1382 427 200
info.dundee@smithsinterconnect.com
- Rouen, France
+33 2 32 96 91 76
info.fr@smithsinterconnect.com
- Elstree, UK
+44 20 8236 2400
info.uk@smithsinterconnect.com

Asia

- Bangalore, India
+91 080 4241 0529
info.in@smithsinterconnect.com
- Singapore
+65 6846 1655
info.asia@smithsinterconnect.com
- Mianyang, China
+86 816 231 5566
HSICSR@hf-smiths.com
- Suzhou, China
+86 512 6273 1188
info.asia@smithsinterconnect.com
- Shanghai, China
+86 21 3318 4650
info.asia@smithsinterconnect.com

more > [smithsinterconnect.com](https://www.smithsinterconnect.com) | [in](#) [twitter](#) [youtube](#)