

LHS | LHZ | LHT Series

Rack & Panel Blind Mating Modular Connectors NF F 61-032



Hypertac® Hyperboloid Technology

Smiths Interconnect offers an extensive range of superior contact technologies suitable for standard and custom solutions. Hypertac® (HYPERboloid conTACT) is the original superior performing hyperboloid contact technology designed for use in all applications and in harsh and demanding environments where high reliability and safety are critical. The inherent electrical and mechanical characteristics of the Hypertac hyperboloid contact ensures unrivalled performance in terms of reliability, number of mating cycles, low contact force and minimal contact resistance. The shape of the contact sleeve is formed by hyperbolically arranged contact wires, which align themselves elastically as contact lines around the pin, providing a number of linear contact paths.

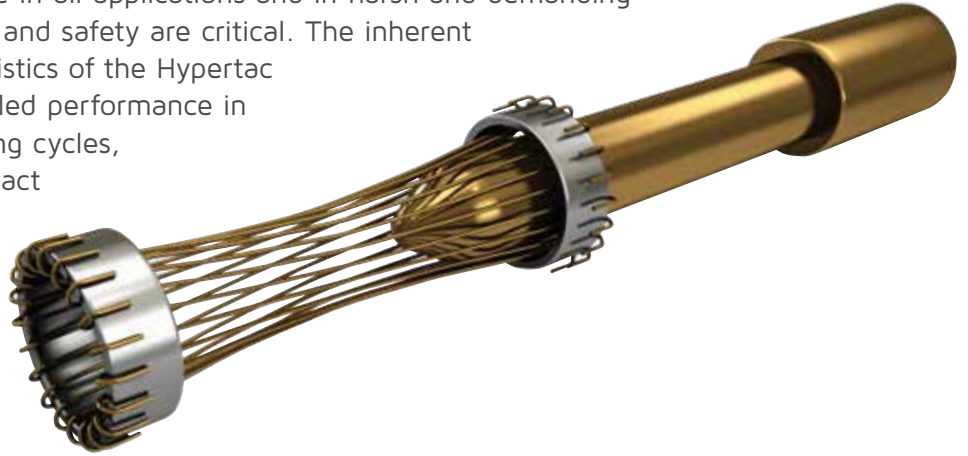

Features

Benefits

Low insertion/extraction forces

The angle of the socket wires allows tight control of the pin insertion and extraction forces. The spring wires are smoothly deflected to make line contact with the pin.

High density interconnect systems

Significant reductions in size and weight of sub-system designs. No additional hardware is required to overcome mating and un-mating forces.

Long contact life

The smooth and light wiping action minimizes wear on the contact surfaces. Contacts perform up to 100,000 insertion/extraction cycles with minimal degradation in performance.

Low cost of ownership

The Hypertac contact technology will surpass most product requirements, thus eliminating the burden and cost of having to replace the connector or the entire subsystem.

Lower contact resistance

The design provides a far greater contact area and the wiping action of the wires insures a clean and polished contact surface. Our contact technology has about half the resistance of conventional contact designs.

Low power consumption

The lower contact resistance of our technology results in a lower voltage drop across the connector reducing the power consumption and heat generation within the system.

Higher current ratings

The design parameters of the contact (e.g., the number, diameter and angle of the wires) may be modified for any requirement. The number of wires can be increased so the contact area is distributed over a larger surface. Thus, the high current carried by each wire because of its intimate line contact, can be multiplied many times.

Maximum contact performance

The lower contact resistance of the Hypertac contact reduces heat build-up; therefore Hypertac contacts are able to handle far greater current in smaller contact assemblies without the detrimental effects of high temperature.

Immunity to shock & vibration

The low mass and resultant low inertia of the wires enable them to follow the most abrupt or extreme excursions of the pin without loss of contact. The contact area extends 360° around the pin and is uniform over its entire length. The 3 dimensional symmetry of the Hypertac contact design guarantees electrical continuity in all circumstances.

Reliability under harsh environments

Harsh environmental conditions require connectors that will sustain their electrical integrity even under the most demanding conditions such as shock and vibration. The Hypertac contact provides unmatched stability in demanding environments when failure is not an option.

Contents

LHS Series

Product description	2
How to order.....	3
Technical characteristics	4
Plug & Receptacle dimensions.....	5
Mounting example	6
Contacts.....	7
Modules	9
Layouts in compliance with NF F 61-032.....	11
Variant layouts	12
Panel cut out	14
Tools	15

LHZ Series

Product description	17
Technical characteristics.....	18
Mounting example	19
Contacts.....	20
Connector layouts with High Speed contacts	21
Tools	24
Rack and panel connector incorporating antenna link	25
Connector configurations.....	26
Technical characteristics.....	27

LHT Series

Technical characteristics.....	28
Plug & Receptacle dimensions.....	29
Receptacle panel cut out.....	32
Tools	32

LHS Series

Coax or Power & Signal only



Smiths Interconnect LHS Series is a flat floating connector mixing power, signal and coaxial contacts. The LHS connectors have been designed to meet the most demanding requirements of the rail transportation industry and is qualified according to SNCF standards. They are ideal for rack & panel, cable and program applications.

The LHS connector range provides a quick and easy connection/disconnection and the float mounting enables to compensate mechanical misalignment up to 1.25mm during blind mating, ensuring an excellent signal integrity. The 14 units of 5.5m pitches allow a high contact density up to 70 signal contacts.

Made with the superior Hypertac® hyperboloid technology, these connectors offer excellent reliability, even under high levels of shock and vibration and maintain life cycle up to 500 mating cycles for a low cost of ownership.

**Railways
approved
flat mount
connectors**

Features & Benefits

Superior Design

- Flat float mount connector
- Guiding pins, ideal for blind mating
- Interchangeable male and female modules
- Rack/panel applications, (norm XPF61-005)
- Compliant with NF F 61-032 standards

Enhanced Functionality

- Easy cabling mounting, cabling process designed with R&D teams of main rolling stock manufacturers
- Designed for the use of standard existing crimp and positioner tools Hypertac® Hyperboloid Contact System
- Reduced cost of ownership through unrivalled contact performance and reliability
- Shock and vibration proofed
- High density up to 70 signal contacts
- Mixed power, signal and coaxial contacts

How To Order



1 Series	L [fixed]
2 Model	H [fixed]
3 Marked Frame*	S [fixed]
4 Layout <i>(Consult the factory)</i> Layouts included L/RH Layouts included L/ZH	<p>Normalized 1 0 2 1 0 4 1 0 8 1 2 0 1 3 0 1 4 7</p> <p>Other 1 0 1 to 1 - -</p> <p>Normalized 3 0 2 3 2 0</p> <p>Other 3 0 1 to 3 - -</p>
5 Part - Polarity	<p>0 1 Plug delivered without contact (except coaxial contacts)</p> <p>0 2 Receptacle delivered without contact (except coaxial contacts)</p>
6 Termination styles	<p>0 0 Without signal contact (and with solder coaxial)</p> <p>2 0 Without signal contact (and with crimp coaxial)</p>
7 Pitch Number	1 4 [fixed]

Only normalized layouts are marked with NF F 61-032

Note:
Signal contacts must be ordered separately (see page 7 and 8 for part number)

Technical Characteristics

Materials & Finishes

Frame	Inox Soft Steel
Side flange	Polycarbonate
Insulator	Polycarbonate
Pin & Socket body	Brass (Au/Ni plated)
Socket wires	Copper alloy (Au/Ni plated)
Floating eyelets	Brass (Ni plated)

Environmental

Temperature range	-40 °C to +100 °C
Fire classification	Exigence 2 following NF F 16-102
Salt spray test	96 hours
Acid withstanding	Following NF F 61-032 par. 11.4.6
Vibration Withstanding	5 g /25 to 250 Hz
Insulator mechanical resistance	1000 N
Max torque for auto threading screws	75 Ncm

Electrical

Contact Ø	1.50	2.50	3.50
Creepage distance	1.85 mm	2.25 mm	4.05 mm
Clearance distance	≈ 1.25 mm	≈ 3.4 mm	≈ 5.40 mm
Working current	8 A	16 A	25 A
Insulation resistance	≥ 5.10 ³ MΩ	≥ 5.10 ³ MΩ	≥ 5.10 ³ MΩ
Contact resistance	≤ 2.50 mΩ	≤ 1.00 mΩ	≤ 0.80 mΩ
Dielectric withstanding voltage	1500 Vrms	2000 Vrms	3000 Vrms
Voltage rating	110 V	220 V	220 V
Contact holding back in the module	40 N	50 N	70 N
Max male contact mass	1.10 g	2.90 g	4.90 g
Max female contact mass	0.70 g	1.60 g	2.70 g
IF/SF* (max value)	1.60 N	9.00 N	10.00 N

* IF/SF: insertion and separation force according to NF F 61-032

Plug & Receptacle Dimensions

Receptacle

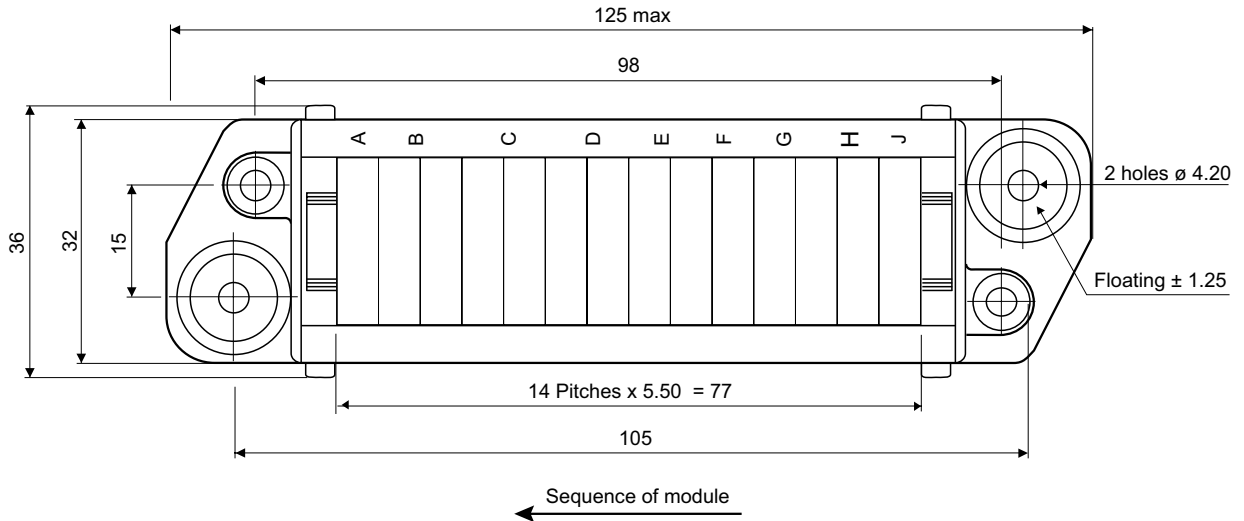

Plug

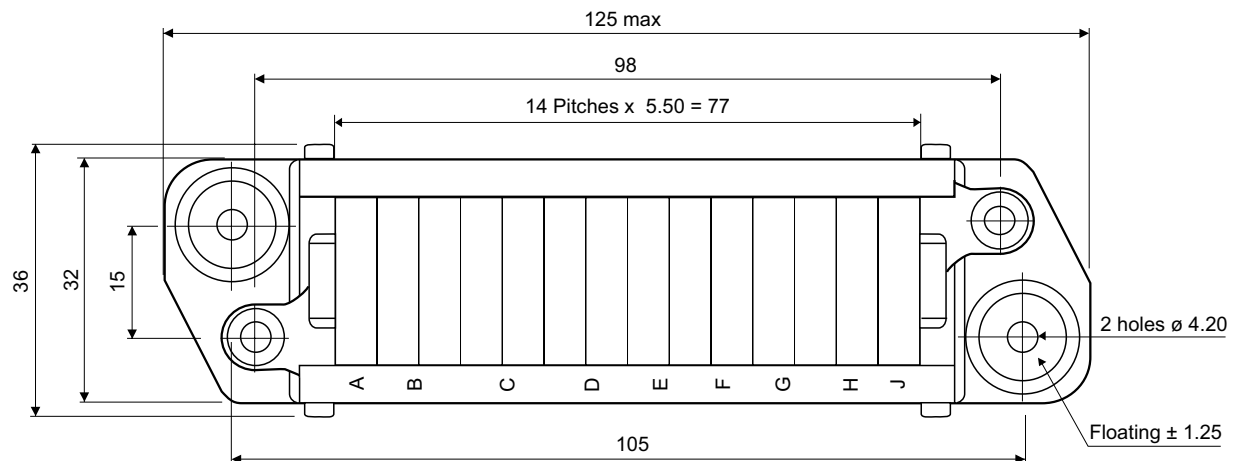
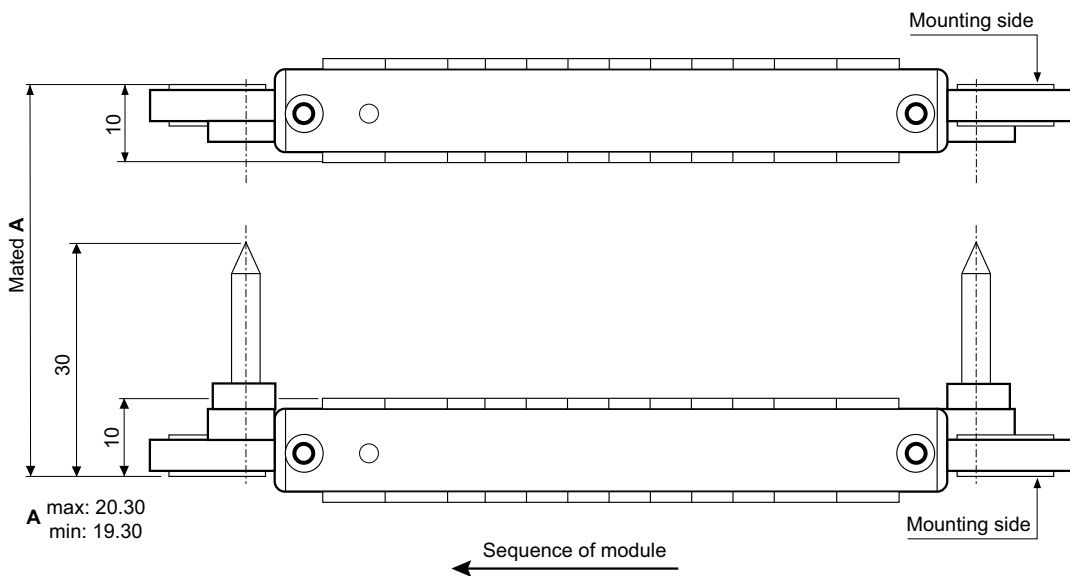

Dimensions are in mm

Mounting Example *(with L/RHA, L/SH, L/UH modules)*

Receptacle cabling side view

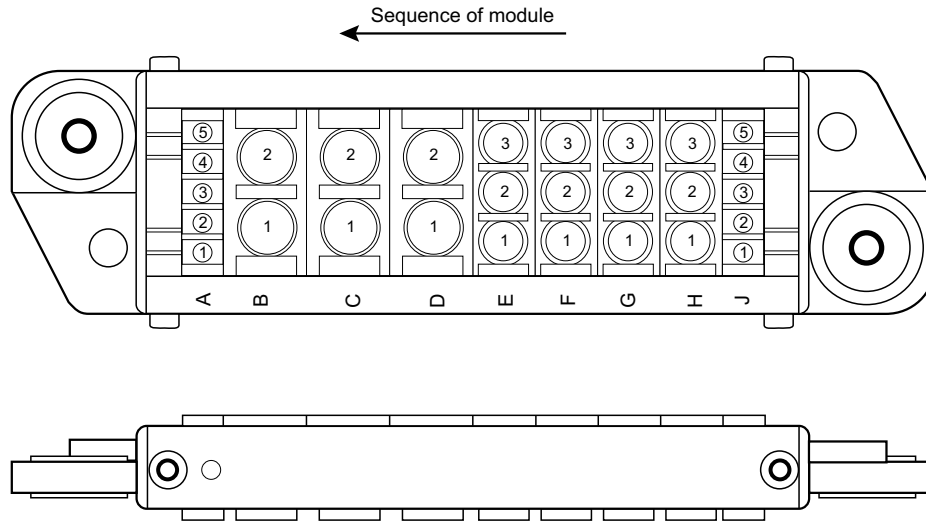

Plug cabling side view

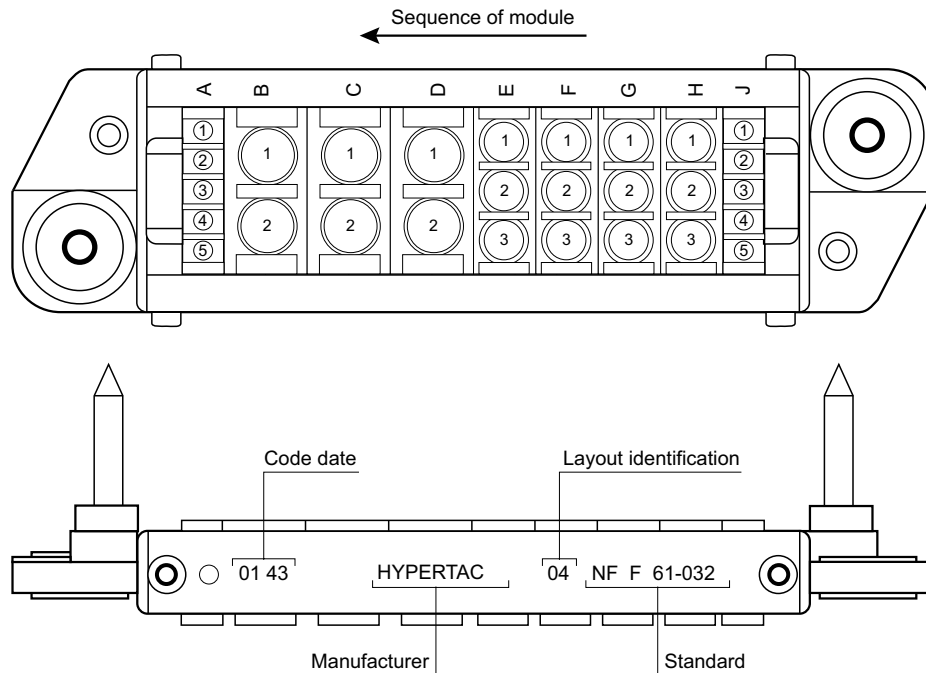

Contacts *(Crimp terminations)*

Male

Female

Ø 1.50 Contacts AWG 26-24-22-20-18-16-14

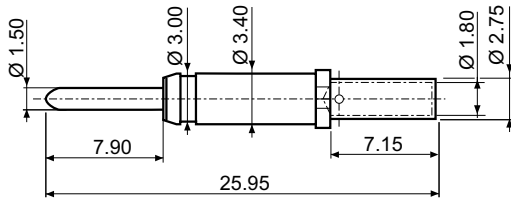

Ref: 015 076 1- 20- OG

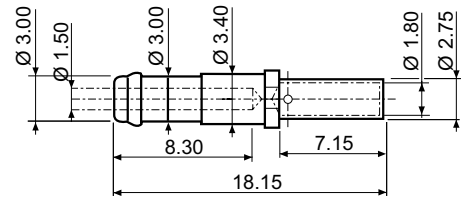

Ref: 015 068 2- 20- G1

Ø 2.50 Contacts*

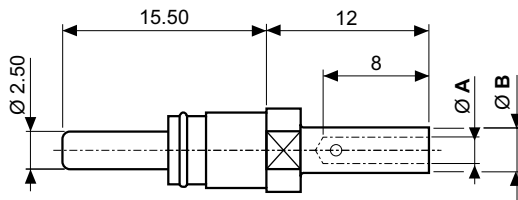

Ref: 025 018 1- 22- OG
Ref: 025 020 1- 23- OG

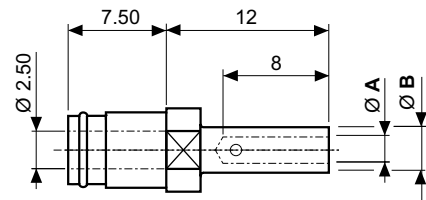

Ref: 025 017 2- 22- G1
Ref: 025 020 2- 23- G1

Ø 3.50 Contacts*

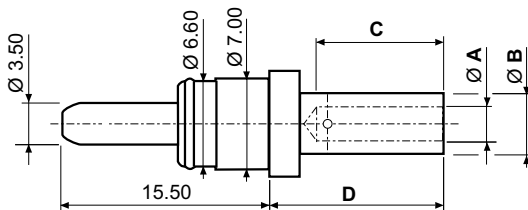

Ref: 035 011 1- 24- OG
Ref: 035 012 1- 25- OG
Ref: 035 013 1- 26- OG
Ref: 035 025 1- 23- OG

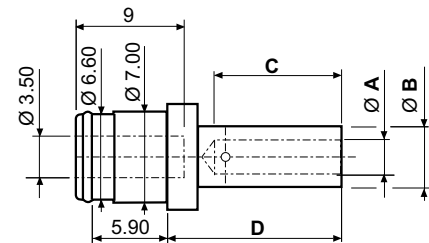

Ref: 035 011 2- 24- G1
Ref: 035 012 2- 25- G1
Ref: 035 013 2- 26- G1
Ref: 035 030 2- 23- G1

Reference	Ø A	Ø B	C	D	AWG*
Ø 2.50					
025 018 1- 22- OG 025 017 2- 22- G1	1.95	3.10	-	-	16-14
025 020 1- 23- OG 025 020 2- 23- G1	1.50	3.10	-	-	22-20-18-16
Ø 3.50					
035 011 1- 24- OG 035 011 2- 24- G1	2.10	4.10	8	12	14-13
035 012 1- 25- OG 035 012 2- 25- G1	1.95	3.10	8	12	16-14
035 013 1- 26- OG 035 013 2- 26- G1	1.50	3.10	8	12	22-17
035 025 1- 23- OG 035 030 2- 23- G1	4.55	5.65	9.50	14	8

Dimensions are in mm

Contacts

Male

Female

Ø 1.50 Contacts - Wire Wrap Termination

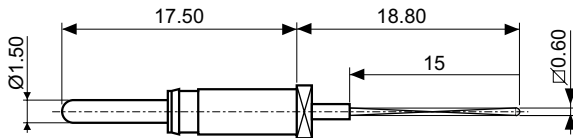

Ref: 015 113 1- 51- OG

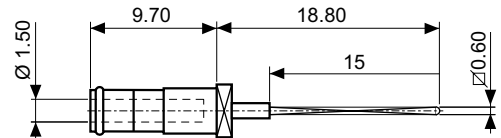

Ref: 015 113 2- 51- G1

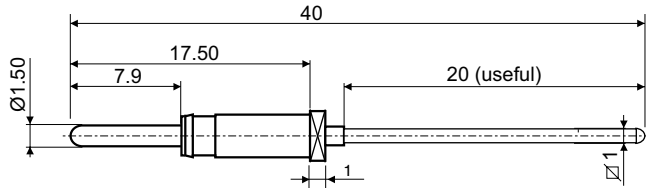

Ref: 015 115 1- 56- OG

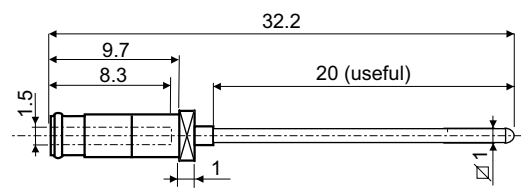

Ref: 015 115 2- 56- G1

Ø 1.50 Contacts - Post Termination

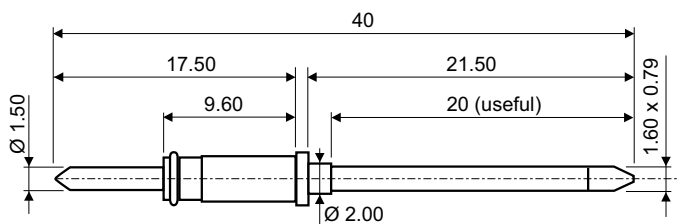

Ref: 015 086 1- 62- OG

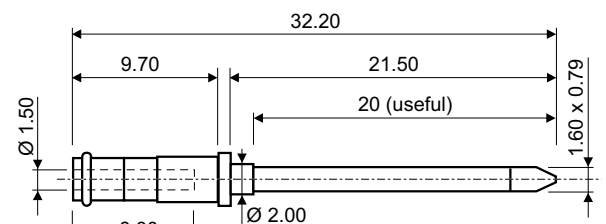

Ref: 015 086 2- 62- G1

Coaxial Contacts

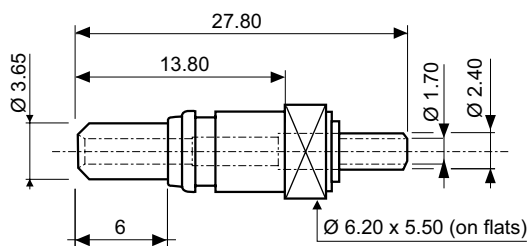

Ref: 037 003 1- XB- U1

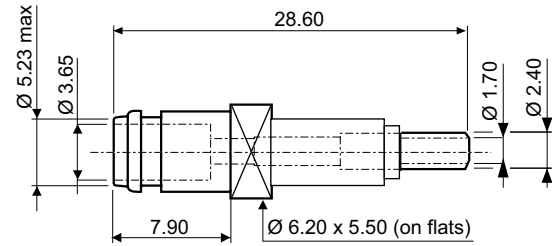

Ref: 037 003 2- XB- U1

Technical Characteristics

Impedance	Cable KX22A (RG316): 50 Ω	cable RG179B/U: 75 Ω
Current rating	3 A	
Contact resistance	Internal ≤ 10 mΩ	External ≤ 0.8 mΩ
Insulation resistance	> 5.10 ³ MΩ (500 VDC)	
Temperature range	-40° C +100° C	
Contact life cycle	> 5000	
Standing wave ratio up to	1.2 (500 MHz)	

Dimensions are in mm

Modules

5 x Ø 1.50

L/RH

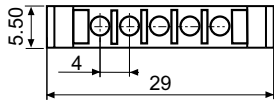
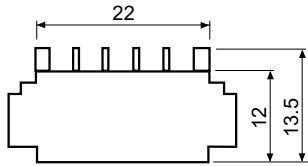

Ref: L-- 515 00 00 RHA

L/ZH

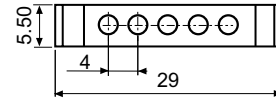
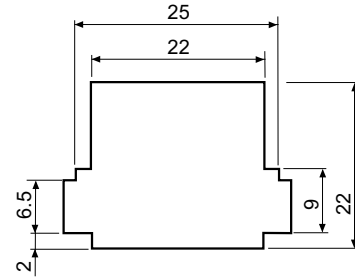

Ref: L -- 515 00 00 ZHA

3 x Ø 2.50

L/SH

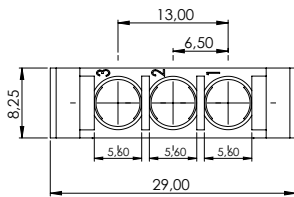
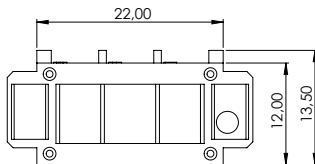

Ref: L-- 325 00 00 SH

2 x Ø 3.50

L/UH

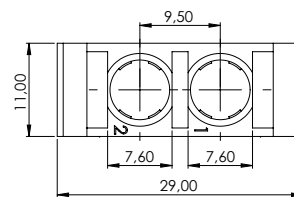
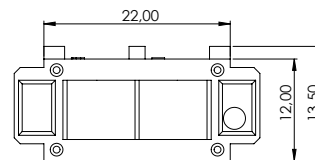

Ref: L-- 235 00 00 UH

Modules Equipped with Contacts for KX15 Coax Cable

L/VM

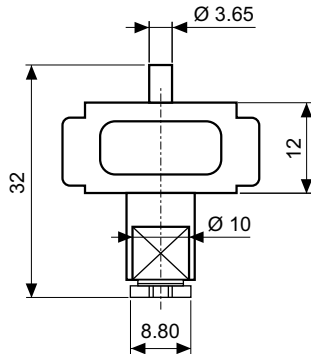

Solder termination Ref: L-- 1CX 11 40 VM
Crimp termination Ref: L-- 1CX 11 20 VPM

L/VF

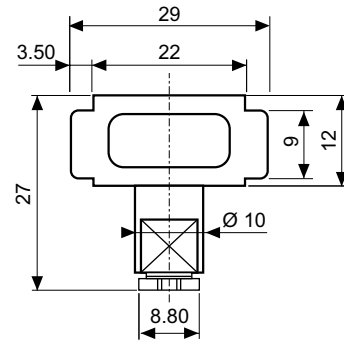

Solder termination Ref: L -- 1CX 20 40 VF
Crimp termination Ref: L -- 1CX 20 20 VPF

Technical Characteristics

Impedance	50 Ω	
Current rating	2 A	
Contact resistance	Internal ≤ 10 m Ω	External ≤ 1 m Ω
Insulation resistance	$> 5 \cdot 10^3$ M Ω (500 VDC)	
Dielectric withstanding voltage	Internal 1000 Vrms	External 4800 Vrms
Temperature range	-40° C +100° C	
Module pitches number	4 as 22 mm	
Recommended cable	KX15	

Layouts in Compliance with NF F 61-032

Ø 1.50 Contacts with L/RH Modules

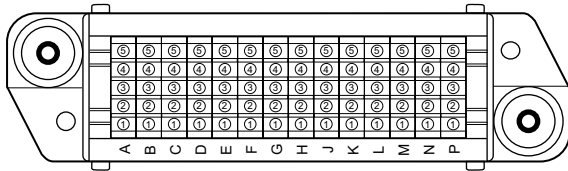

Ref: 02/102 14 modules L/RH

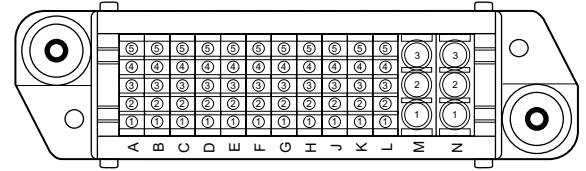

Ref: 20/120 11 modules L/RH
2 modules L/SH

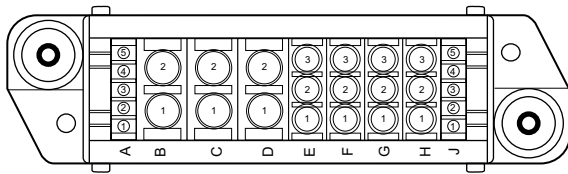

Ref: 04/104 2 modules L/RH
4 modules L/SH
3 modules L/UH

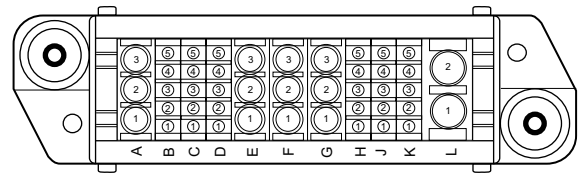

Ref: 30/130 6 modules L/RH
4 modules L/SH
1 module L/UH

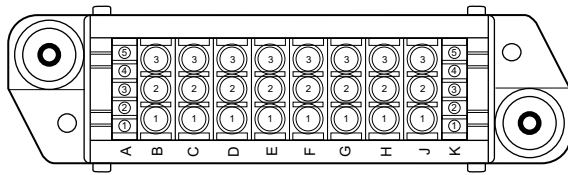

Ref: 08/108 2 modules L/RH
8 modules L/SH

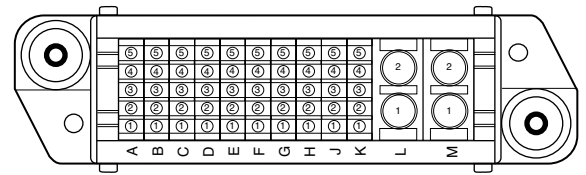

Ref: 47/147 10 modules L/RH
2 modules L/UH

Ø 1.50 Contacts with L/ZH Modules

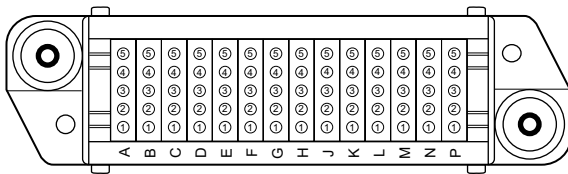

Ref: 202/302 14 modules L/ZH

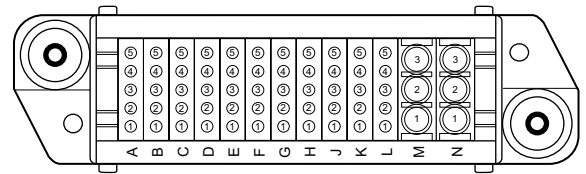

Ref: 220/320 11 modules L/ZH
2 modules L/SH

Note: only receptacle layouts are represented termination side view

Variant Layouts

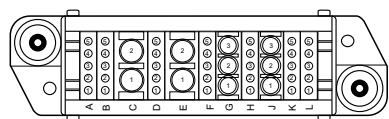

Ref: 201/301 7 modules L/ZH
2 modules L/SH
2 modules L/UH

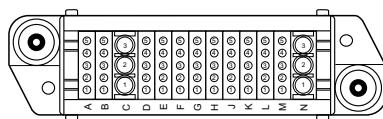

Ref: 209/309 11 modules L/ZH
2 modules L/SH

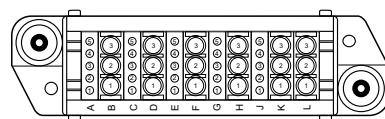

Ref: 217/317 5 modules L/ZH
6 modules L/SH

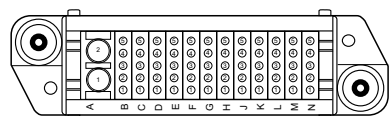

Ref: 203/303 12 modules L/ZH
1 module L/UH

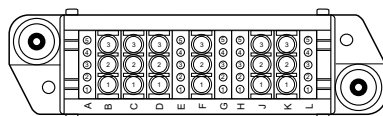

Ref: 210/310 5 modules L/ZH
6 modules L/SH

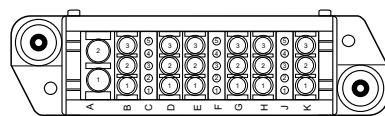

Ref: 219/319 3 modules L/ZH
6 modules L/SH
1 module L/UH

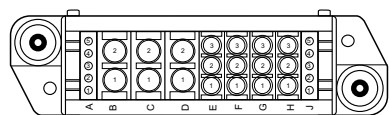

Ref: 204/304 2 modules L/ZH
4 modules L/SH
3 modules L/UH

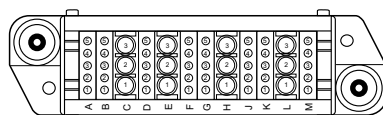

Ref: 211/311 8 modules L/ZH
4 modules L/SH

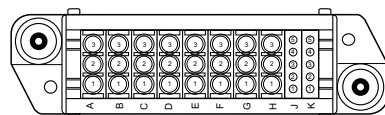

Ref: 222/322 2 modules L/ZH
8 modules L/SH

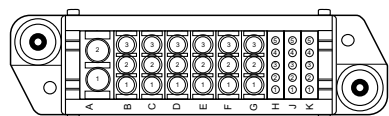

Ref: 205/305 3 modules L/ZH
6 modules L/SH
1 module L/UH

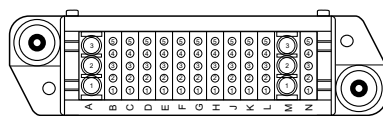

Ref: 212/312 11 modules L/ZH
2 modules L/SH

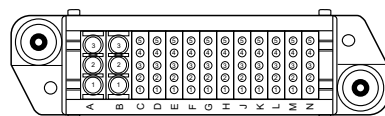

Ref: 223/323 11 modules L/ZH
2 modules L/SH

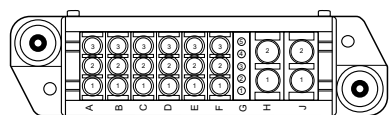

Ref: 206/306 1 modules L/ZH
6 modules L/SH
2 modules L/UH

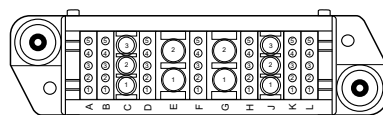

Ref: 213/313 7 modules L/ZH
2 modules L/SH
2 modules L/UH

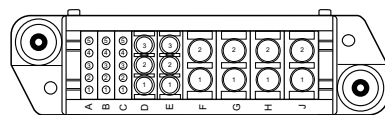

Ref: 224/324 3 modules L/ZH
2 modules L/SH
4 modules L/UH

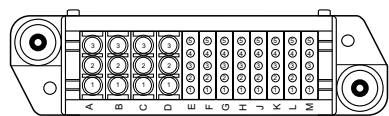

Ref: 207/307 8 modules L/ZH
4 modules L/SH

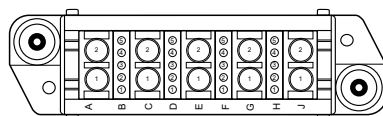

Ref: 215/315 4 modules L/ZH
5 modules L/UH

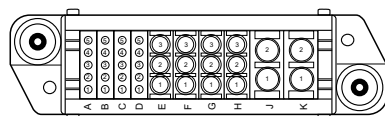

Ref: 225/325 4 modules L/ZH
4 modules L/SH
2 modules L/UH

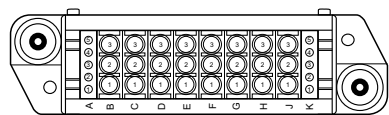

Ref: 208/308 2 modules L/ZH
8 modules L/SH

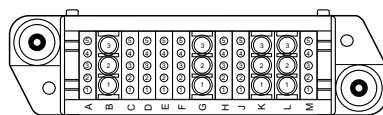

Ref: 216/316 8 modules L/ZH
4 modules L/SH

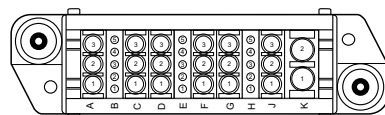

Ref: 226/326 3 modules L/ZH
6 modules L/SH
1 module L/UH

Note: only receptacle layouts are represented termination side view

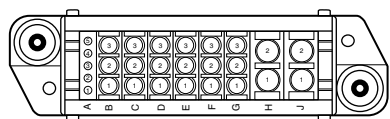

Ref: 227/327 1 module L/ZH
6 modules L/SH
2 modules L/UH

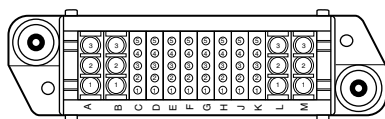

Ref: 235/335 8 modules L/ZH
4 modules L/SH

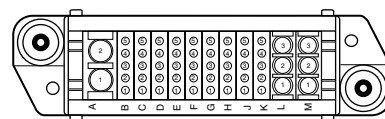

Ref: 242/342 9 modules L/ZH
2 modules L/SH
1 module L/UH

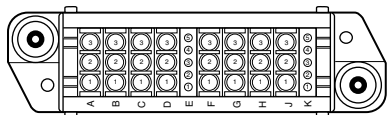

Ref: 229/329 2 modules L/ZH
8 modules L/SH

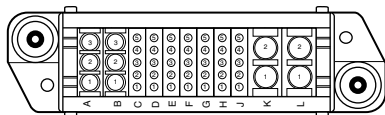

Ref: 236/336 7 modules L/ZH
2 modules L/SH
2 modules L/UH

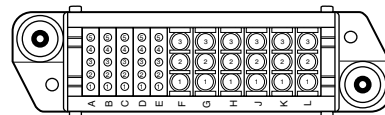

Ref: 243/343 5 modules L/ZH
6 modules L/SH

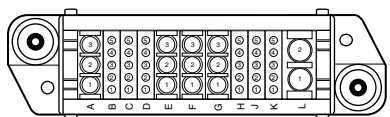

Ref: 230/330 6 modules L/ZH
4 modules L/SH
1 module L/UH

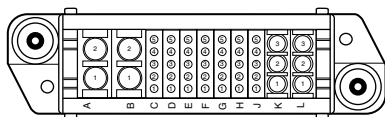

Ref: 237/337 7 modules L/ZH
2 modules L/SH
2 modules L/UH

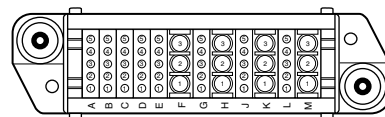

Ref: 245/345 8 modules L/ZH
4 modules L/SH

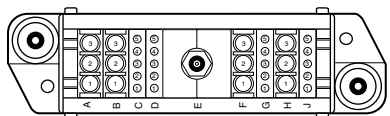

Ref: 231/331 4 modules L/ZH
4 modules L/SH
1 module L/V-

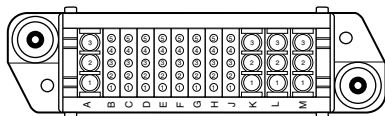

Ref: 238/338 8 modules L/ZH
4 modules L/SH

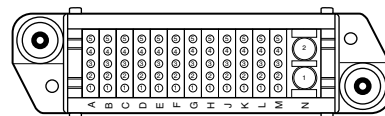

Ref: 246/346 12 modules L/ZH
1 modules L/UH

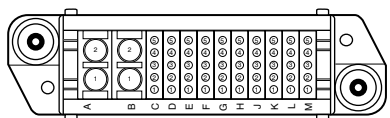

Ref: 232/332 10 modules L/ZH
2 modules L/UH

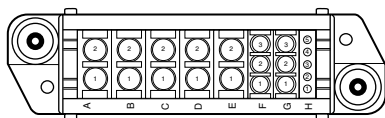

Ref: 239/339 1 module L/ZH
2 modules L/SH
5 modules L/UH

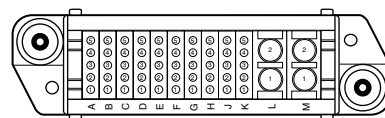

Ref: 247/347 10 modules L/ZH
2 modules L/UH

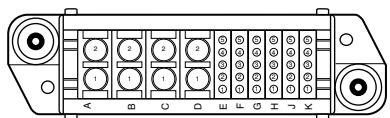

Ref: 233/333 6 modules L/ZH
4 modules L/UH

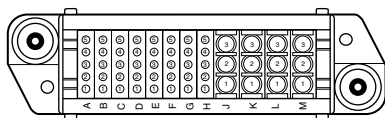

Ref: 240/340 8 modules L/ZH
4 modules L/SH

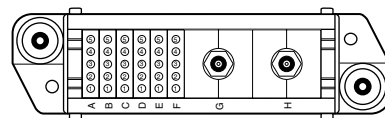

Ref: 250/350 6 modules L/ZH
2 modules L/V-

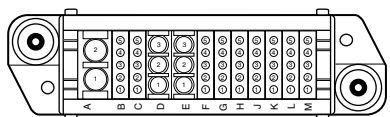

Ref: 234/334 9 modules L/ZH
2modules L/SH
1 module L/UH

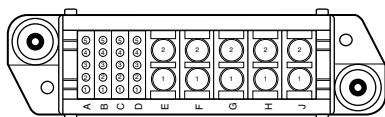

Ref: 241/341 4 modules L/ZH
5 modules L/SH

Note: only receptacle layouts are represented termination side view. Contact us for specific contact layouts

Panel Cut Out

Receptacle Panel Cut Out

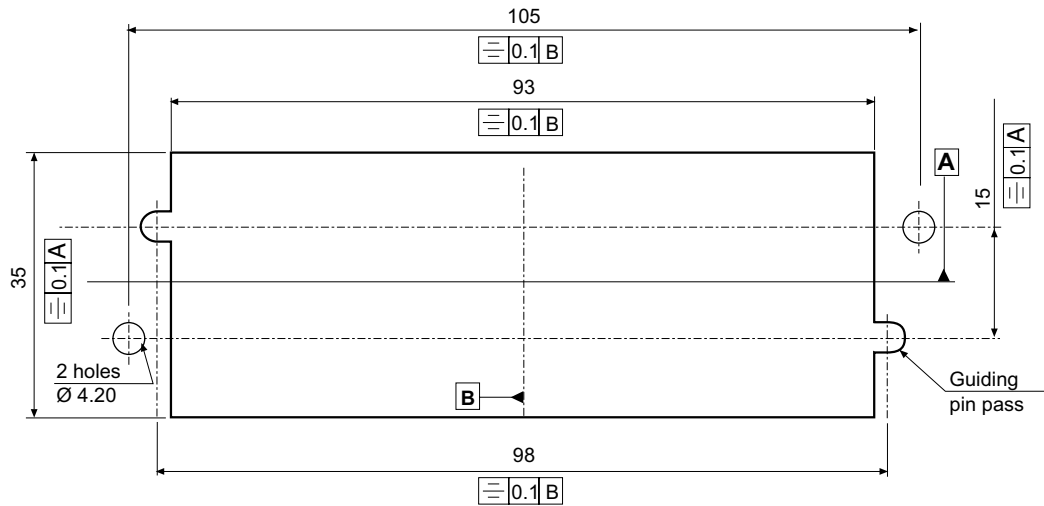

Plug Panel Cut Out

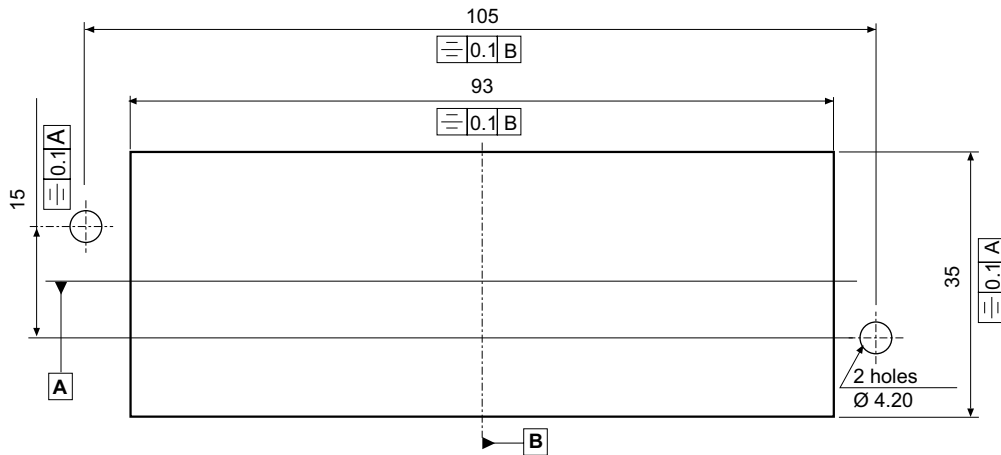

Tools

Crimping

Contact Part number	Crimp tool	AWG	Wire cross section	Positioner	Tool turret	Selector position
015 068 2- 20- G1 015 076 1- 20- OG	ASTRO TOOL TGV 101	24 22 20 18 16 14	0.22 0.34 0.60 0.93 1.34 1.91		ASTRO TOOL TGV 202 red	2 3 4 5 6 7
	DANIELS FT8	24 22 20 18 16 14	0.22 0.34 0.60 0.93 1.34 1.91		DANIELS SH 463 Red	2 3 4 5 6 7
025 018 1- 22- OG 025 017 2- 22- G1	ASTRO TOOL TGV 101	16 15 15 14 14	1.34 1.50 1.82 1.91 2.00		ASTRO TOOL TGV 202 blue	6 6 7 7 7
	DANIELS FT8	16 15 15 14 14	1.34 1.50 1.82 1.91 2.00		DANIELS SH 463 blue	6 6 7 7 7
025 020 1- 23- OG 025 020 2- 23- G1	ASTRO TOOL TGV 101	22 20 18 18 16	0.34 0.60 0.93 1.00 1.34		ASTRO TOOL TGV 202 blue	5 6 6 6 6
	DANIELS FT8	22 20 18 18 16	0.34 0.60 0.93 1.00 1.34		DANIELS SH 463 blue	5 6 6 6 6
035 011 1- 24- OG 035 011 2- 24- G1	DANIELS M317	14 14 13	1.91 2.00 2.50		DANIELS TP 805	3 3 4
	ASTRO TOOL TGV 515	14 14 13	1.91 2.00 2.50	Without	ASTRO TOOL TGV 503	3 3 4
035 012 1- 25- OG 035 012 2- 25- G1	DANIELS M317	16 15 14 14	1.34 1.50 1.91 2.00		DANIELS TP 805	2 2 3 3
	ASTRO TOOL TGV 515	16 15 14 14	1.34 1.50 1.91 2.00	Without	ASTRO TOOL TGV 503	2 2 3 3
035 013 1- 26- OG 035 013 2- 26- G1	DANIELS M317	22 20 18 18	0.38 0.60 0.93 1.00		DANIELS TP 805	1 1 2 2
	ASTRO TOOL TGV 515	22 20 18 18	0.38 0.60 0.93 1.00	Without	ASTRO TOOL TGV 503	1 1 2 2
035 025 1- 23- OG 035 030 2- 23- G1	DANIELS M300 BT	8	8.98		M22520/1,05	4

Insertion and Extraction Tools

	Males	Females		
Contact Ø	Part number	Part number	Insertion tool	Extracting tool
1.50	015 076 1-20-OG	015 068 2-20-G1	S_059 ⁽¹⁾ S_051 SM-0150000002 ⁽²⁾ SM-0150000003 ⁽³⁾ SME-0150000000 ⁽⁴⁾	S__ 051 S__ 072 S__ 083
2.50	025 018 1-22-OG 025 020 1-23-OG	025 017 2-22-G1 025 020 2-23-G1	SE-0250000001	S__ 078 S__ 083
3.50	035 011 1-24-OG 035 012 1-25-OG 035 013 1-26-OG 035 025 1-23-OG	035 011 2-24-G1 035 012 2-25-G1 035 013 2-26-G1 035 030 2-23-G1	SE-0350000001	S__ 083 ⁽⁵⁾

(1) straight tool

(2) unwedge tool

(3) bent tool

(4) straight, unwedge and bent tools kit

(5) tool for Ø 1.50, 2.50 and 3.50 contacts

LHZ Series

Mixed power, signal, coaxial and high speed contacts



Smiths Interconnect LHZ Series is a flat floating connector mixing power, signal, coaxial and high speed contacts, designed especially for the transmission of Ethernet high-speed signals required in harsh environment railway applications.

High speed contacts are available in Twinax, Triax and Quadrax versions. The inner contact uses the Hypertac® hyperboloid technology and offers excellent reliability, even under high levels of shock and vibration.

The contact system meets the requirements of Ethernet Class F (CAT 7). It is compliant with IEE802.3 and achieves more than 1.2 GHz. Cables of an impedance of 100, 120 and 150, and of sizes from 6.5 mm to 13 mm diameter can be used.

**Designed for
the transmission
of Ethernet
high-speed signals**

Features & Benefits

Superior Design

- Technology designed especially for the transmission of Ethernet high-speed signals required in harsh environment railway applications.
- Design combining the benefits of the hyperboloid technology with a ruggedised shell housing.
- Modular design; Twinax, Triax and Quadrax versions
- Performances meeting the evolutions of the railway industry requirements: signal frequencies of more than 1.2 GHz

Hypertac® Hyperboloid Contact System

- Reduced cost of ownership through unrivalled contact performance and reliability
- Shock and vibration proofed: use of the 1.02mm hyperboloid socket contact
- Mixed power, signal, coaxial and high speed contacts

Enhanced Functionality

- Ruggedised connector: 1 million balancing cycles testing
- Easy cabling mounting: cabling process designed with R&D teams of the main rolling stock manufacturers. Cables used 100, 120 or 150 Ω
- Male and female modules are interchangeable
Design for use of standard existing tools: crimp tool and positioner

Technical Characteristics

Electrical

Current rating	7.5 A
Contact resistance	< 3.5 mΩ
Withstanding voltage	2000 V

Mechanical

Contact rotation	70daN.cm
Contact retention	>250N
Contact pull	>250N
Mating cycles	>500 cycles

Environmental

Dry heat	1000H at 100° C (standard value: 96H)
Temperature range	-55° C at +100° C, 5 cycles
Salt spray	96H (5% NaCl)
Damped heat	56 days (40° C 90/95% HR)
Fire and Smoke	According to NF F 16-101, NF F 16-102

Mounting Example with B/HD

Male

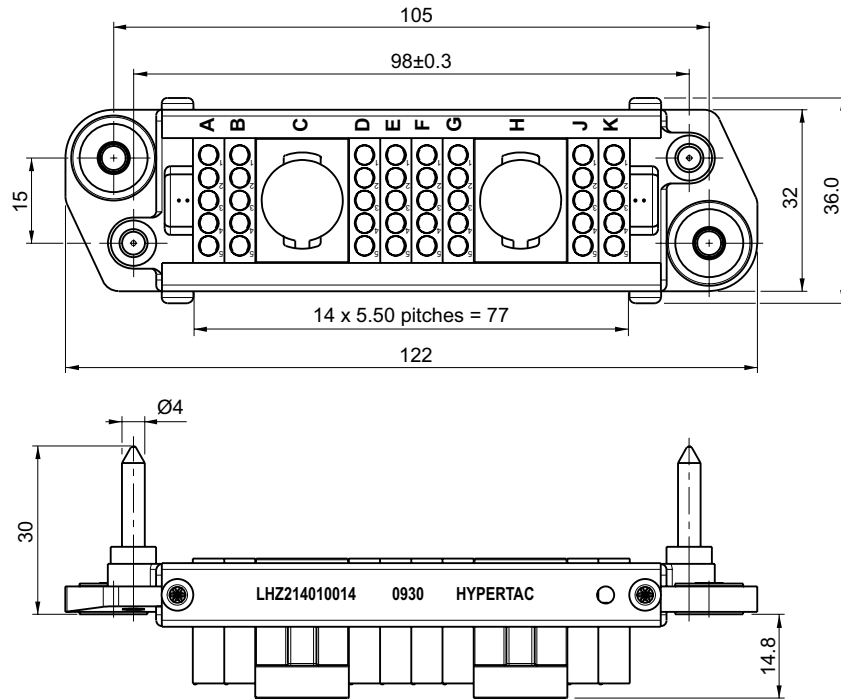

Female

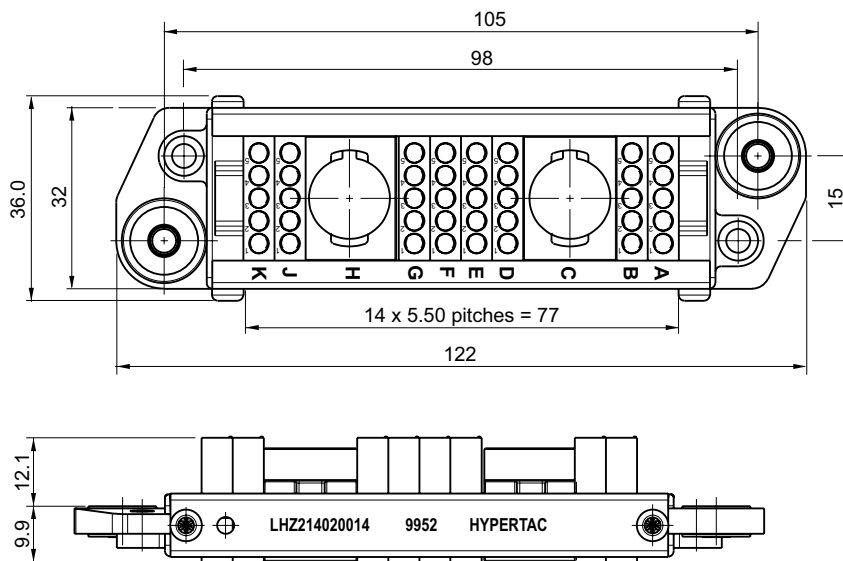

Contacts

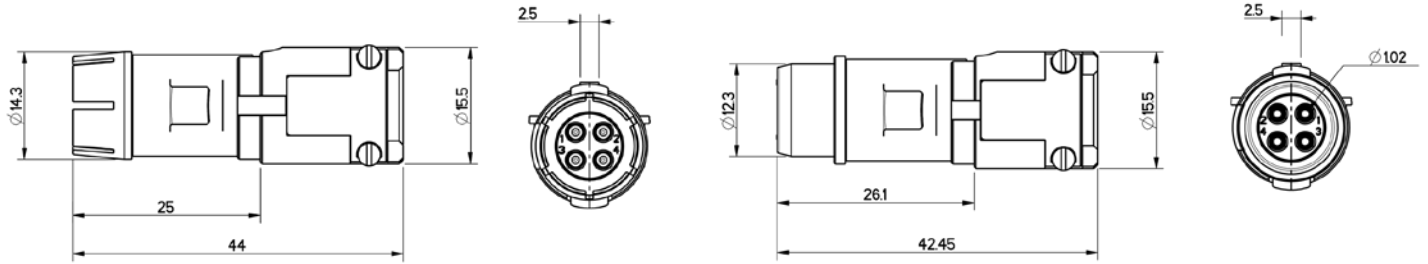

Male	Female
Ref: 123 012 1- QAR 01	Ref: 123 012 2- QAR 01
Ref: 123 010 1- QAR 01 (SNCF qualified)	Ref: 123 010 2- QAR 01 (SNCF qualified)

Modules

Plug

Receptacle

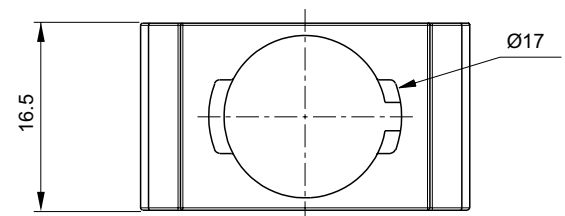
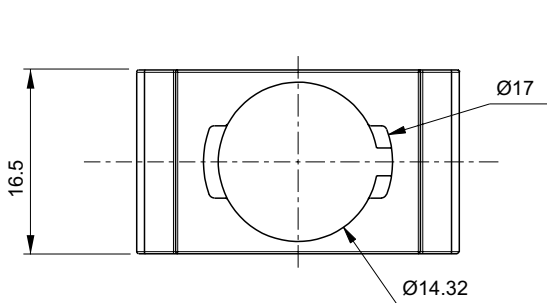
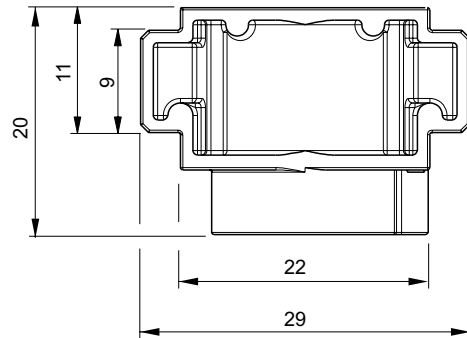
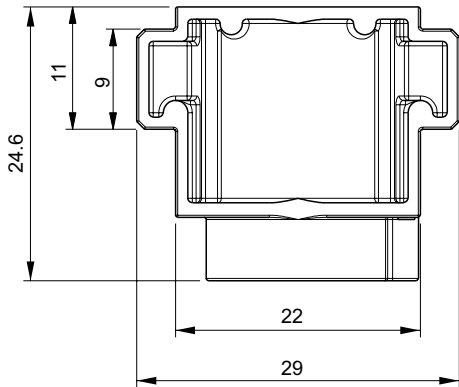

Note: For other configurations, please contact us
 Dimensions are in mm

LHZ Connector Layout

with high speed contacts

Receptacles

Can be mating with

Plugs

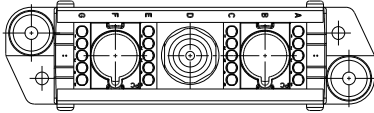

Part number

Female receptacle: LHZ 203 02 00 14

Modules

4 x ZHA
2 x HDFH
1 x VLF

Coaxial contact with crimp connection for cable KX4

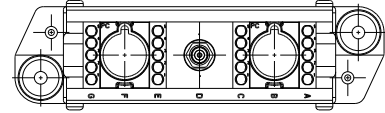

Part number

Male plug: LHZ 202 01 00 14

Modules

4 x ZHA
2 x HDMH
1 x 1VM

Coaxial contact with solder connection for cable KX15

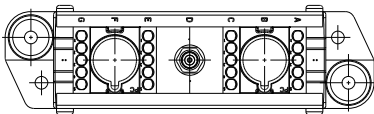

Part number

Female receptacle: LHZ 213 02 00 14

Modules

4 x ZHA
2 x HDFH
1 x VF

Coaxial contact with solder connection for cable KX15

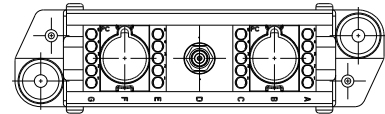

Part number

Male plug: LHZ 202 01 00 14

Modules

4 x ZHA
2 x HDMH
1 x 1VM

Coaxial contact with solder connection for cable KX15

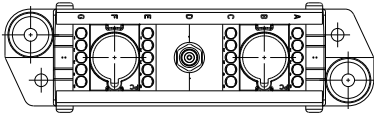

Part number

Female receptacle: LHZ 217 02 00 14

Modules

4 x ZHA
2 x HDFH
1 x VPF

Coaxial contact with crimp connection for cable KX15

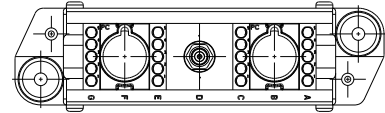

Part number

Male plug: LHZ 202 01 00 14

Modules

4 x ZHA
2 x HDMH
1 x 1VM

Coaxial contact with solder connection for cable KX15

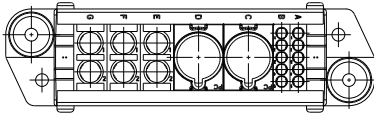

Part number

Female receptacle: LHZ 206 02 00 14

Modules

2 x ZHA
2 x HDFH
3 x UH

Coaxial contact with crimp connection for cable KX15

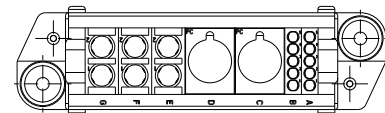

Part number

Male plug: LHZ 206 01 00 14

Modules

2 x ZHA
2 x HDMH
3 x UH

Coaxial contact with solder connection for cable KX15

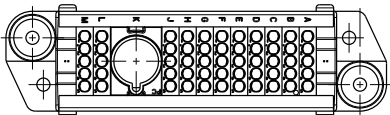

Part number

Female receptacle: LHZ 209 02 00 14

Modules

11 x ZHA
1 x HDFH

Male receptacle: LHZ 208 02 00 14

11 x ZHA
1 x HDMH

Coaxial contact with crimp connection for cable KX4

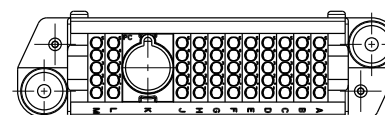

Part number

Male plug: LHZ 208 01 00 14

Modules

11 x ZHA
1 x HDMH

Female plug: LHZ 209 01 00 14

11 x ZHA
1 x HDFH

Coaxial contact with crimp connection for cable KX4

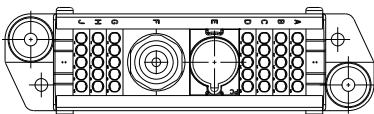

Part number

Female receptacle: LHZ 212 02 00 14

Modules

7 x ZHA
1 x HDFH
1 x VLF

Coaxial contact with crimp connection for cable KX4

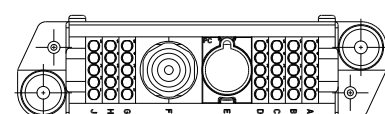

Part number

Male plug: LHZ 211 01 00 14

Modules

7 x ZHA
1 x HDMH
1 x VLM

Coaxial contact with crimp connection for cable KX4

Note: Signal contacts must be ordered separately see page 7 and 8

Receptacles

Can be mating with

Plugs

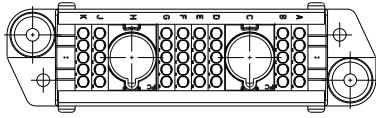

Part number

Female receptacle: LHZ 214 02 00 14

Modules

8 x ZHA
2 x HDFH

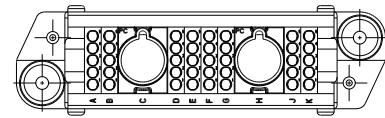

Part number

Male plug: LHZ 214 01 00 14

Modules

8 x ZHA
2 x HDMH

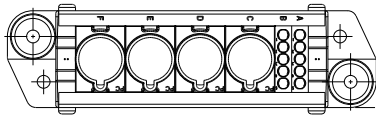

Part number

Female receptacle: LHZ 216 02 00 14

Modules

2 x ZHA
4 x HDFH

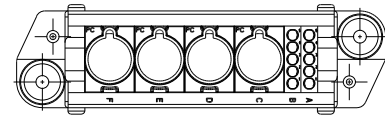

Part number

Male plug: LHZ 215 01 00 14

Modules

2 x ZHA
4 x HDMH

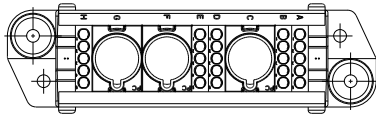

Part number

Female receptacle: LHZ 219 02 00 14

Modules

5 x ZHA
3 x HDFH

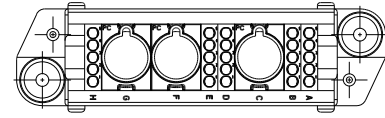

Part number

Male plug: LHZ 218 01 00 14

Modules

5 x ZHA
3 x HDMH

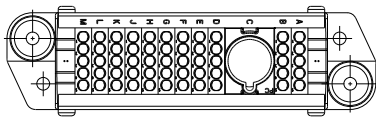

Part number

Female receptacle: LHZ 221 02 00 14

Modules

11 x ZHA
1 x HDFH

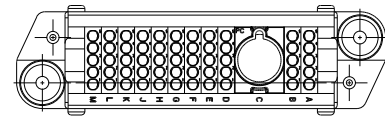

Part number

Male plug: LHZ 220 01 00 14

Modules

11 x ZHA
1 x HDMH

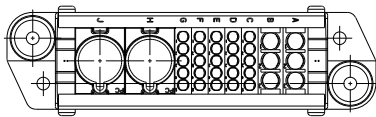

Part number

Female receptacle: LHZ 225 02 00 14

Modules

5 x ZHA
2 x HDFH
2 x SH

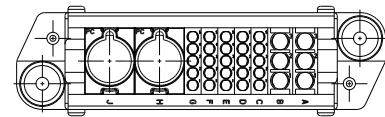

Part number

Male plug: LHZ 225 01 00 14

Modules

5 x ZHA
2 x HDMH
2 x SH

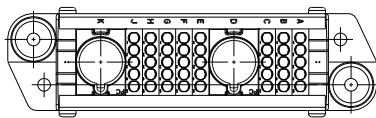

Part number

Female receptacle: LHZ 226 02 00 14

Modules

8 x ZHA
2 x HDFH

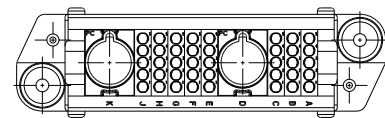

Part number

Male plug: LHZ 226 01 00 14

Modules

8 x ZHA
2 x HDMH

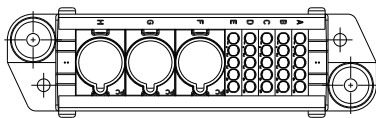

Part number

Female receptacle: LHZ 231 02 00 14

Modules

5 x ZHA
3 x HDFH

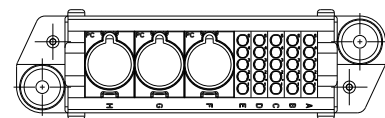

Part number

Male plug: LHZ 231 01 00 14

Modules

5 x ZHA
3 x HDMH

Note: Signal contacts must be ordered separately see page 7 and 8

Receptacles

Can be mating with

Plugs

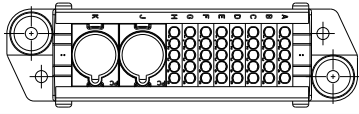

Part number

Female receptacle: LHZ 232 02 00 14

Modules

8 x ZHA
2 x HDFH

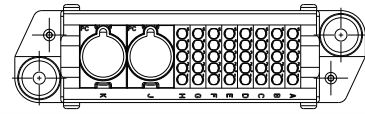

Part number

Male plug: LHZ 232 01 00 14

Modules

8 x ZHA
2 x HDMH

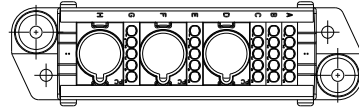

Part number

Female receptacle: LHZ 236 02 00 14

Modules

5 x ZHA
3 x HDFH

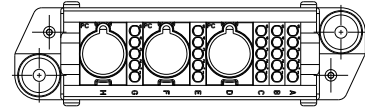

Part number

Male plug: LHZ 235 01 00 14

Modules

5 x ZHA
3 x HDMH

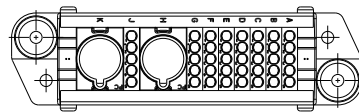

Part number

Female receptacle: LHZ 238 02 00 14

Modules

8 x ZHA
2 x HDFH

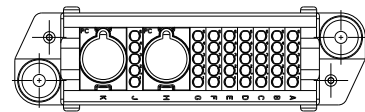

Part number

Male plug: LHZ 237 01 00 14

Modules

8 x ZHA
2 x HDMH

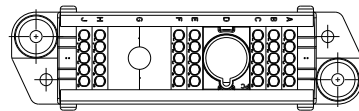

Part number

Female receptacle: LHZ 240 02 00 14

Modules

7 x ZHA
1 x HDFH
1 x VH

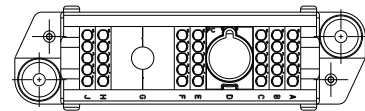

Part number

Male plug: LHZ 239 01 00 14

Modules

7 x ZHA
1 x HDMH
1 x VH

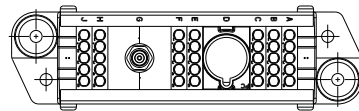

Part number

Female receptacle: LHZ 242 02 00 14

Modules

7 x ZHA
1 x HDFH
1 x VF

Coaxial contact with solder connection for cable KX15

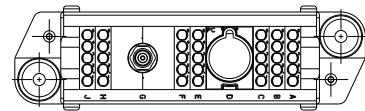

Part number

Male plug: LHZ 241 01 00 14

Modules

7 x ZHA
1 x HDMH
1 x VM

Coaxial contact with solder connection for cable KX15

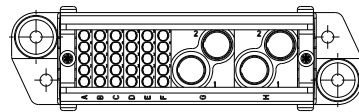

Part number

Female receptacle: LHZ 601 02 00 14

Delivered with the accessorie

Modules

6 x ZHA
2 x 2Twinax
L_183

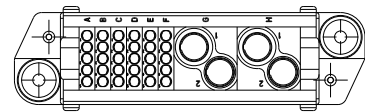

Part number

Male plug: LHZ 601 01 00 14

Modules

6 x ZHA
2 x 2Twinax

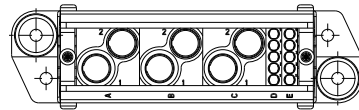

Part number

Female receptacle: LHZ 602 02 00 14

Delivered with the accessorie

Modules

2 x ZHA
3 x 2Twinax
L_183

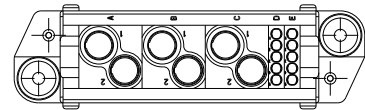

Part number

Male plug: LHZ 602 01 00 14

Modules

2 x ZHA
3 x 2Twinax

Example with L_183

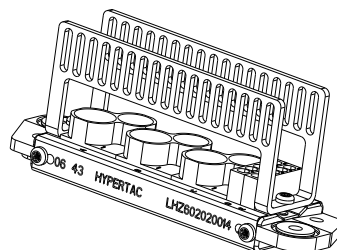

Note: Signal contacts must be ordered separately see page 7 and 8

Tools

Contacts		Crimping Tool			Tools	
Arrangement	Part number	Crimping Tool	Tool turret	Position & Wire Section	Insertion	Extraction
P01 & A01	123 012 1- QAR 01	Astro-tool TGV 101	TGV 210	S.055	S.132	
		Daniels FT8	TP 945			
P02	123 012 2- QAR 01	Astro-tool TGV 101	TGV 210			
		Daniels FT8	TP 945			

LHZ Series

Rack & Panel connector incorporating antenna link for GPS or ERTMS transmissions

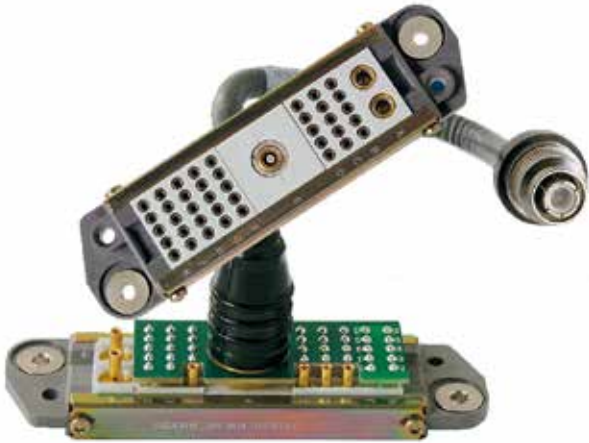

**PCB embedded
within the connector**

The European Rail Traffic Management System (ERTMS) was originated by the European Community (EC) to create a unique Automatic Train Control and railways management system to enable interoperability throughout the European rail network. ERTMS is the combination of the new control-command system ETCS (European Train Control System) and the new GSM-R radio system for voice and data communication. The ERTMS project has been set up to ensure safe operation of the trains in the network and to deal with the traffic and infrastructure management issues enabling the optimisation of the capacity of the lines and the utilisation of the fleet. The ERTMS project involves six major suppliers in seven countries (UK, France, Spain, the Netherlands, Germany, Switzerland and Italy).

The project and solution itself represented a number of challenges as it needed to be retro-fitted to a wide variety of existing rolling stock and a unique identifier, used in conjunction with GPS tracking, was to be included. To meet these needs, Smiths Interconnect created the Nuloc custom connector. This uses Hyperboloid contact technology to achieve low contact resistance and robust electrical connection.

The device implements the identification function by integrating a recognition code on a printed circuit embedded within the connector receptacle. This code is programmed during the final manufacturing phase. The ERTMS interconnection system also integrates a coaxial cable assembly to link to the GPS/GSM-R antenna and each cable assembly must be dimensioned to the locomotive type. This is also done during the manufacturing process according to instructions specific to each order.

Like all connectors targeted for rail applications, strict governmental, EC and customer-specified standards exist, all of which must be met if not exceeded. These standards, such as the French NF F 61-030, mean connectors must have the appropriate plating and materials to withstand salt-spray, humidity and industrial gas tests.

Technical Characteristics

Materials and Platings

Frame	Soft steel (Zinc coated)
Side flange	Polycarbonate
Insulator	Polycarbonate
Pin & socket body	Brass (Au/Ni plated)
Socket wires	Copper alloy (Au/Ni plated)
Floating eyelets	Brass (Ni plated)

Environmental & Mechanical

Temperature range	-40° C to +100° C
Fire classification	Level 2 following NF F 16-102
Salt spray test	96 hours
Acid withstanding	Following NF F 61-032 par. 11.4.6
Vibration withstanding	5g / 25 to 250 Hz
Insulator mechanical resistance	1000 N

Electrical

Contact	Ø 1.50	Ø 2.50	Ø 3.50
Creepage distance	1.85 mm	2.25 mm	4.05 mm
Clearance distance	1.25 mm	3.40 mm	5.40 mm
Working current	8 A	16 A	25 A
Insulation resistance	≥ 5.10 ³ MΩ		
Contact resistance	≤ 2.50 mΩ	≤ 1.00 mΩ	≤ 0.80 mΩ
Dielectric withstanding voltage	1500 Vrms	2000 Vrms	3000 Vrms
Voltage rating	110 V	220 V	220 V
Contact retention	40 N	50 N	70 N
Maxi male contact mass	1.10 g	2.90 g	4.90 g
Maxi female contact mass	0.70 g	1.60 g	2.70 g
IF/SF* (max value)	1.60 N	9.00 N	10.00 N
Coaxial contact	Ø 3.65		
Nominal impedance	50 Ω		
Frequency range	1.5 Hz		
RF transmission loss	0.05db at 1 HHz - 0.06db at 1.5 GHz		

*IF/SF: insertion and separation force according to NF F 61-032

Antenna cable assembly receptacle connector

Cable & contact technical characteristics

Impedance

Impedance	50 Ω
-----------	-------------

Cable 1/4' mechanical characteristics

Zero halogen	
External diameter	6.40 mm
Static bending radius	25 mm mini
Dynamic bending radius	45 mm mini
Max pull force	500 N
α @ 1500 MHz	24db/100m

Transmissions losses

	1.0 GHz	1.5 GHz
Hypertac coaxial contact	0.05db	0.06db
Coaxial cable	19db/100m	24db/100m
TNC contact	-	0.06db
N contact	0.05db	-

Cable assembly transmission loss: versus length

Length	1.0 GHz	1.5 GHz
0.25m	0.15db	0.18db
0.50m	0.2db	0.24db
0.75m	0.25db	0.30db
1m	0.29db	0.36db
1.25m	0.34db	0.42db
1.50m	0.39db	0.48db
1.75m	0.44db	0.54db
2m	0.48db	0.60db
2.25m	0.53db	0.66db
2.50m	0.58db	0.72db
2.75m	0.63db	0.78db
3m	0.67db	0.84db
3.25m	0.72db	0.90db
3.50m	0.77db	0.96db
3.75m	0.82db	1.02db
4m	0.86db	1.08db
4.25m	0.91db	1.14db
4.50m	0.96db	1.20db
4.75m	1.01db	1.26db
5m	1.05db	1.32db

LHT Series

With plate inserts for safe wire protection

Technical Characteristics

Electrical

Contact Ø	1.50 mm
Creepage distance	1.85 mm
Clearance distance	≈ 1.25 mm
Connector current rating	8 A @ 50°C
Insulation resistance	≥ 5 x 10 ³ MΩ
Contact resistance	≤ 2.50 mΩ
Dielectric withstanding voltage	1500 Vrms
Voltage rating	110 V
Contact retention	40 N
Floating eyelets	Brass (Ni plated)

Environmental

Temperature range	-40 to +100°C
Life cycles	> 500
Fire classification	Exigence 2 following NFF 16-102
Salt spray test	96 hours
Acid withstanding	Following NFF 61-032 par. 11.4.6
Vibration withstanding	5 g / 25 to 250 Hz
Insulator mechanical resistance	1000 N
Max torque for auto threading screws	75 Ncm

Plug and Receptacle Dimensions

Connectors equipped with 13 ZHA modules and 7 plate inserts

Receptacle

Part number: LHT 112 02 00 14

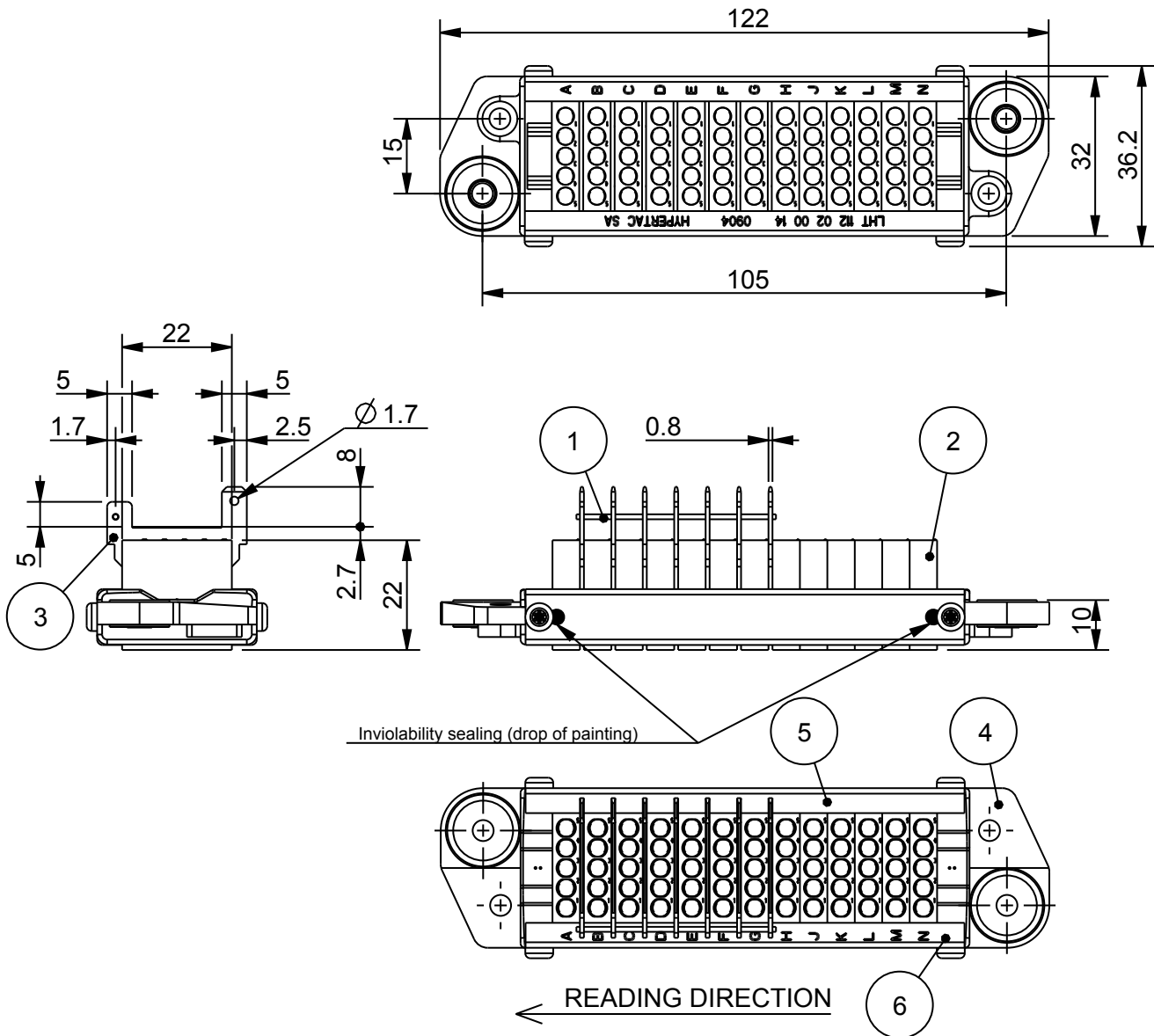

Number	Part descriptions
1	Copper wire \varnothing 1mm
2	Module L/ZHA
3	Female plate insert
4	Tailpiece
5	Rail
6	Labeled rail

Note: Signal contacts must be ordered separately see page 7
Dimensions are in mm

Pug

Part number: LHT 111 01 00 14

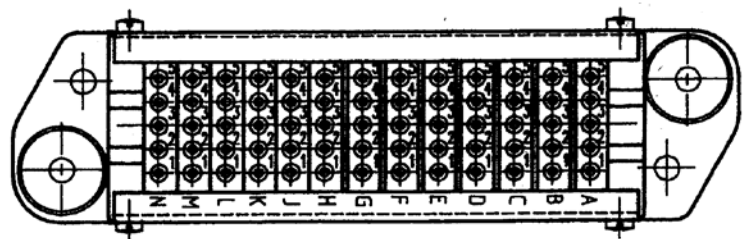
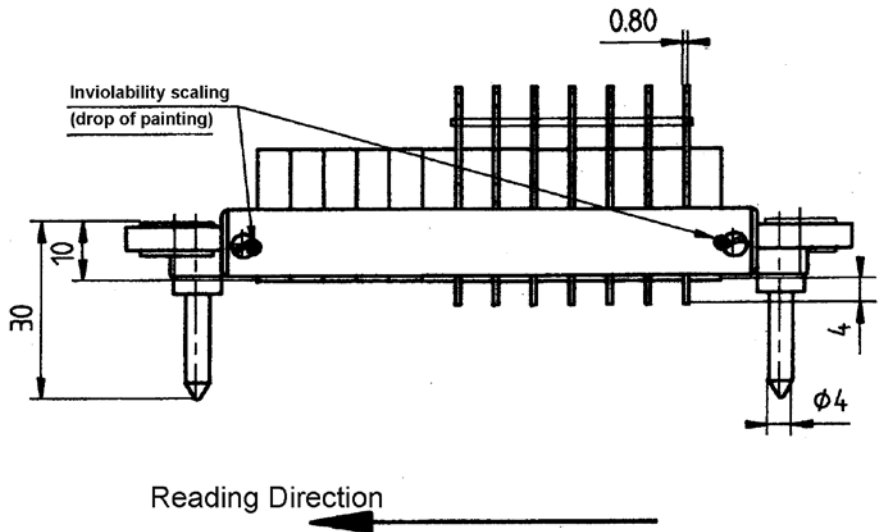
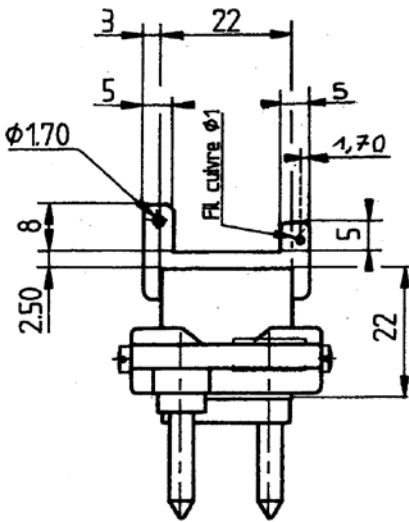
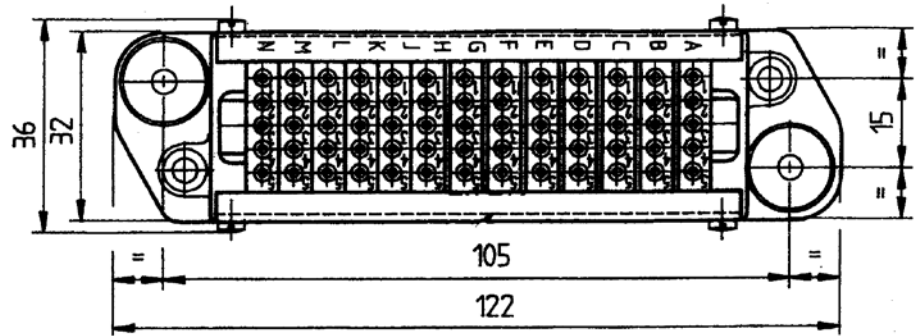

Note: Signal contacts must be ordered separately see page 7
Dimensions are in mm

Panel Cut Out

Receptacle Panel Cut Out

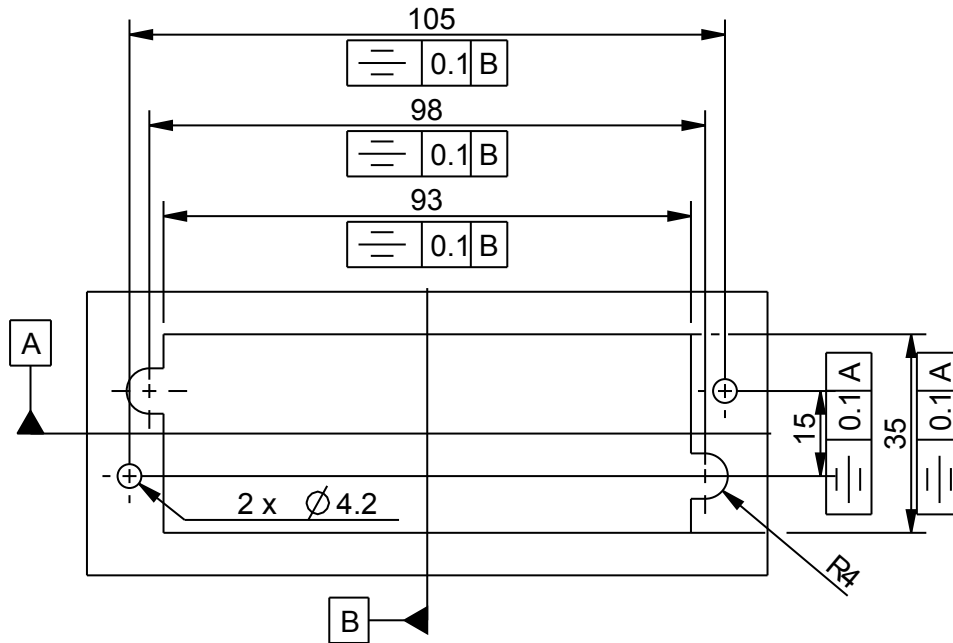

Dimensions are in mm

Tooling

Contact Part number	Crimp tool	AWG	Wire cross section (mm ²)	Positioner	Tool turret	Selector position	Mounting Insertion	Dismantling Extraction
015 068 2- 20-G1	Astro-tool TGV 101	22	0.34	Without	COJACK TGV 202 red	3	S_051	S_051
		20	0.60			4		
		18	0.93			5	or	or
		16	1.34			6		
		14	1.91			7	S_074	S_072

Disclaimer

All of the information included in this catalogue is believed to be accurate at the time of printing. It is recommended, however, that users should independently evaluate the suitability of each product for their intended application and be sure that each product is properly installed, used and maintained to achieve desired results.

Smiths Interconnect makes no warranties as to the accuracy or completeness of the information, and disclaims any liability regarding its use.

Smiths Interconnect reserves the right to modify design and specifications, in order to improve quality, keep pace with technological development or meet specific production requirements.

No reproduction or use without express permission of editorial and pictorial content, in any manner.

Product Portfolio



- Antenna Systems
- Cable Assemblies
- Connector Solutions
- Ferrite Components & Assemblies
- RF Filter Components & Assemblies
- Integrated Microwave Assemblies
- Millimeter-Wave Solutions
- RF Components
- Test Sockets and WLCSP Probe Heads
- Time & Frequency Systems

Worldwide Support

Connectors

Americas

Sales

connectors.uscsr@smithsinterconnect.com

Technical Support

connectors.ustechsupport@smithsinterconnect.com

Europe

Sales

connectors.emeacsr@smithsinterconnect.com

Technical Support

connectors.emeatechsupport@smithsinterconnect.com

Asia

Sales

asiacsr@smithsinterconnect.com

Technical Support

asiatechsupport@smithsinterconnect.com

Fiber Optics & RF Components

Americas

Sales

focom.uscsr@smithsinterconnect.com

Technical Support

focom.techsupport@smithsinterconnect.com

Europe

Sales

focom.emeacsr@smithsinterconnect.com

Technical Support

focom.techsupport@smithsinterconnect.com

Asia

Sales

focom.asiacsr@smithsinterconnect.com

Technical Support

focom.techsupport@smithsinterconnect.com

Semiconductor Test

Americas

Sales

semi.uscsr@smithsinterconnect.com

Technical Support

semi.techsupport@smithsinterconnect.com

Europe

Sales

semi.emeacsr@smithsinterconnect.com

Technical Support

semi.techsupport@smithsinterconnect.com

Asia

Sales

semi.asiacsr@smithsinterconnect.com

Technical Support

semi.techsupport@smithsinterconnect.com

RF/MW Subsystems

Americas, Europe & Asia

Sales

subsystems.csr@smithsinterconnect.com

Technical Support

subsystems.techsupport@smithsinterconnect.com

Connecting Global Markets

more > [smithsinterconnect.com](https://www.smithsinterconnect.com)

