

# EZiCoax

One-Piece Coax for Interposer Solutions

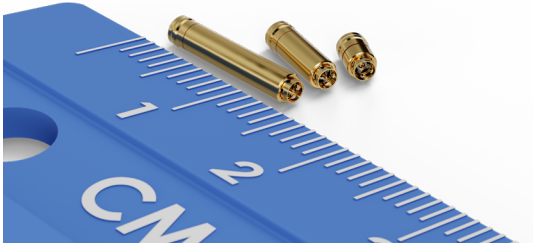

# EZiCoax Technology



Smiths Interconnect, a Molex company, is a global leader in spring-contact probe design and the industry's expert in applying spring probes as connector contacts. EZiCoax is a single-piece, compression-mount, RF Coax that transmits signals between two PCBs.

## Single-Piece Coax

EZiCoax utilizes spring probe technology for the center contact and shield which provides a compliant contact between two PCBs. Alignment is achieved with an Interposer that can integrate other features such as gaskets and bosses.

## Reliability in Harsh Environments

The durable design of Smiths Interconnect spring probes enables interposers built for high performance in the harshest conditions. From environmental stresses like shock, vibration, salt, sand, dust, heat, to even the vacuum of space, Smiths Interconnect ensures a reliable, fail-safe connection.

## Solderless Solution

EZiCoax requires no solder on the PCBs for connection. Each contact requires less than 5 oz. compression force to provide reliable contact.

## Lower Cost of Ownership

EZiCoax requires no assembly, it is sufficient to align to the PCB and compress. EZiCoax interposers can be installed and uninstalled with minimum effort.

## Ideal for Blind Mate

EZiCoax interposers are compliant, allowing unique blind mate capabilities. They are an ideal approach for quick disconnect of applications for system repair or replacement.

## High Frequency

EZiCoax Interposers perform well out to 40 GHz with less than -1 dB of Insertion Loss. They have superior shielding from stray signals and provide excellent crosstalk characteristics.

## Accommodates Target Misalignment

Spring probe connectors are compliant and require only a flat pad as their target. Contact is maintained as long as the probe tip touches any point within the target. This ensures forgiveness of any X, Y, Z and angular misalignment.



### X Misalignment

Contacts are moved from the x-axis but connection is not affected.

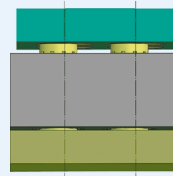

### Y Misalignment

Contacts are moved from the y-axis but connection is not affected.



### Z Misalignment

Contacts are engaged from different z-axis points without impacting performance.

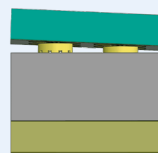

### Angular Misalignment

Contacts are engaged at varying angles.

# Technical Characteristics

Pitch	0.125 [3.20]
Contact termination	Compression Mount
Coax Diameter	0.089 [2.25]
Shield Diameter	0.066 [1.70]
Compression Force	< 5 oz.[141.8 g.]

## Mechanical & Environmental

Temperature Rating	-55° to 165°C
Shock	IEC 60068-2-27, Half sine, 100 g, 6 ms
Vibration	EIA-364-28, Test Condition VI, 53.79 G rms
Contact Life Cycles	1000

## Material & Finishes

Insulator	TPX RT-18	
Signal & Shield Plunger	Beryllium Copper	
Contact Plating	Gold over Nickel	
Spring	Stainless steel	
Outgassing	TML=0.50	CVCM=0.17

## Electrical

Current Rating (*)	1.0 A at 30°C rise, nominal
Bandwidth	-1 dB at 40 GHz
Nominal Impedence	50 Ω
Insulation Resistance	> 5,000 MΩ at 500 VDC
DWV	500 V RMS
Power	12 W at 22 GHz

\*Qualification with reference to ESCC Specification No. 3402, Issue 5.  
Qualification report available upon request.

# EZiCoax Portfolio

## Dimensions and Specifications

The following pages highlight Smiths Interconnect EZiCoax portfolio. This information is intended as a reference for interposer design specification only, as these coaxes are not available for individual purchase. Other designs may be available. Consult a Smiths Interconnect technical expert for more information.

### COMMON DIMENSIONS FOR ALL LENGTHS

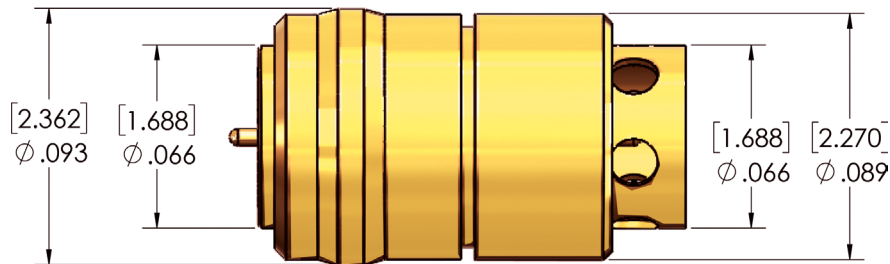

### 851-1001909-0130

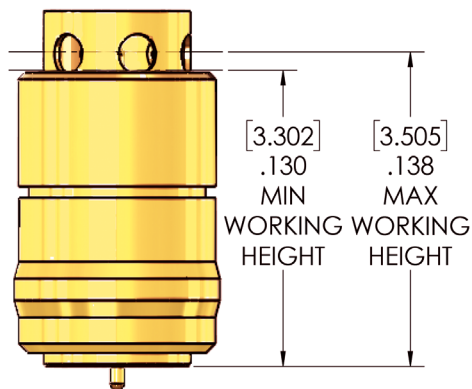

#### Coax Specifications

<b>Part Number</b>	851-1001909-0130
<b>Minimum Centers</b>	0.125 [3.2]
<b>Current Rating</b>	1 A continuous (individual probe in free air at ambient temperature)
<b>Compression Force</b>	5 oz (141.8 g) @ .130 in. [3.3 mm] Working Height
<b>Typical Impedance</b>	50 $\Omega$
<b>Working Range</b>	0.130 to 0.138 [3.3 to 3.5]

## 851-1001909-300

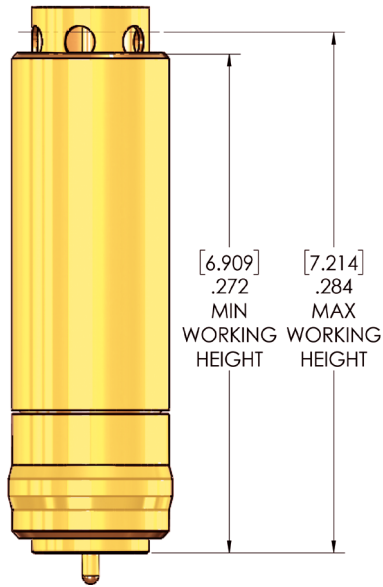

### Coax Specifications

<b>Part Number</b>	851-1001909-300
<b>Minimum Centers</b>	0.125 [3.2]
<b>Current Rating</b>	1 A continuous (individual probe in free air at ambient temperature)
<b>Compression Force</b>	5 oz (141.8 g) @ .268 in. [6.8 mm] Working Height
<b>Typical Impedance</b>	50 Ω
<b>Working Range</b>	0.268 to 0.280 [6.8 to 7.1]

## 851-1001909-500

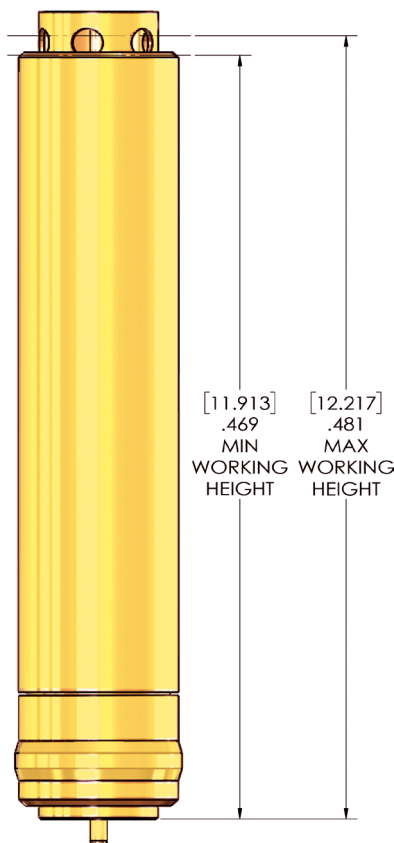

### Coax Specifications

<b>Part Number</b>	851-1001909-500
<b>Minimum Centers</b>	0.125 [3.20]
<b>Current Rating</b>	1 A continuous (individual probe in free air at ambient temperature)
<b>Compression Force</b>	5 oz (141.8 g) @ .130 in. [3.3] Working Height
<b>Typical Impedance</b>	50 Ω
<b>Working Range</b>	0.467 to 0.479 [11.86 to 12.17]

## OTHER OPTIONS - EXAMPLE

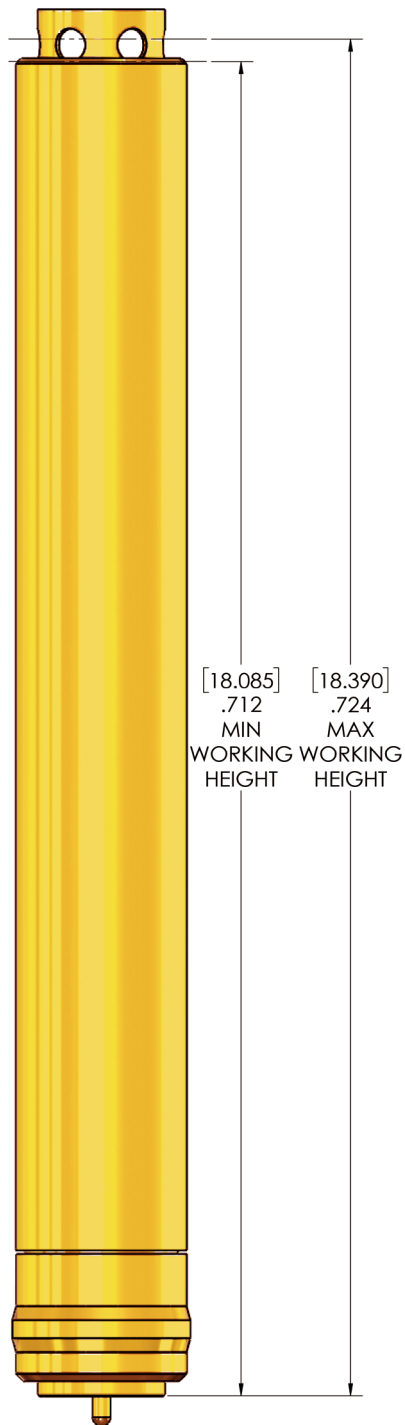

## Coax Specifications

<b>Part Number</b>	Consult Factory
<b>Minimum Centers</b>	0.125 [3.20]
<b>Current Rating</b>	1 A continuous (individual probe in free air at ambient temperature)
<b>Compression Force</b>	5 oz (141.8 g) @ .130 in. [3.3] Working Height
<b>Typical Impedance</b>	50 $\Omega$
<b>Working Range</b>	0.712 to 0.724 [18.08 to 18.39]

# Custom Interposer Features

## Alignment, Housing, Sealing & Termination Options

Smiths Interconnect custom interposers are designed to ensure industry-leading reliability and performance with the flexibility to incorporate application-specific features.

EZiCoax can be integrated into Spring Probe interposers to solve complex connections, featuring digital, signal and powers contacts in a single solution.

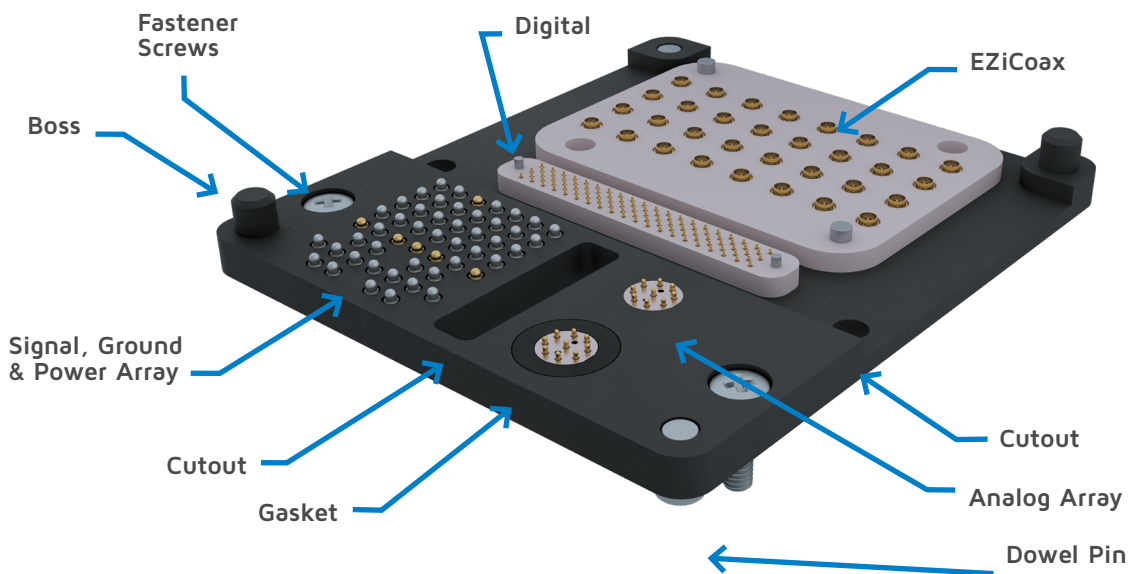

### Signal Patterns

In analyzing an application, specific probe and array configurations are recommended to perfectly balance the footprint requirements with optimal electrical performance.

#### Coaxial Impedance

EZiCoax is designed to provide a 50 Ohm RF connection, alternatively, spring probes can be arranged to match any impedance for reliable RF transmission

#### Digital

Two complimentary contacts with equal and opposite signals can be arranged to provide 100 Ohm impedance for data transmission.

#### Spring Probe Arrays

Signal, power, ground/return pins, and mixed signal configurations.

### Alignment Features

To ensure compatibility with the customer's exact footprint, Smiths Interconnect utilizes precision-machined and molded housing features. This allows for accurate mating orientation, as well as clearance of board components.

#### Dowel Pins

Stainless steel guide posts.

#### Bosses

Molded stud features.

#### Cutout

Slot or hole which avoids a board feature or provides clearance for other components.

# Performance

## EZiCoax RF PERFORMANCE 0.130 [3.30] BOARD-TO-BOARD

The top line in the graph (right) shows the Insertion Loss or Attenuation in dB versus Frequency. The bottom line shows the Return Loss versus Frequency. There is less than -1 dB Insertion Loss and greater than -15 dB of Return Loss through 40 GHz.

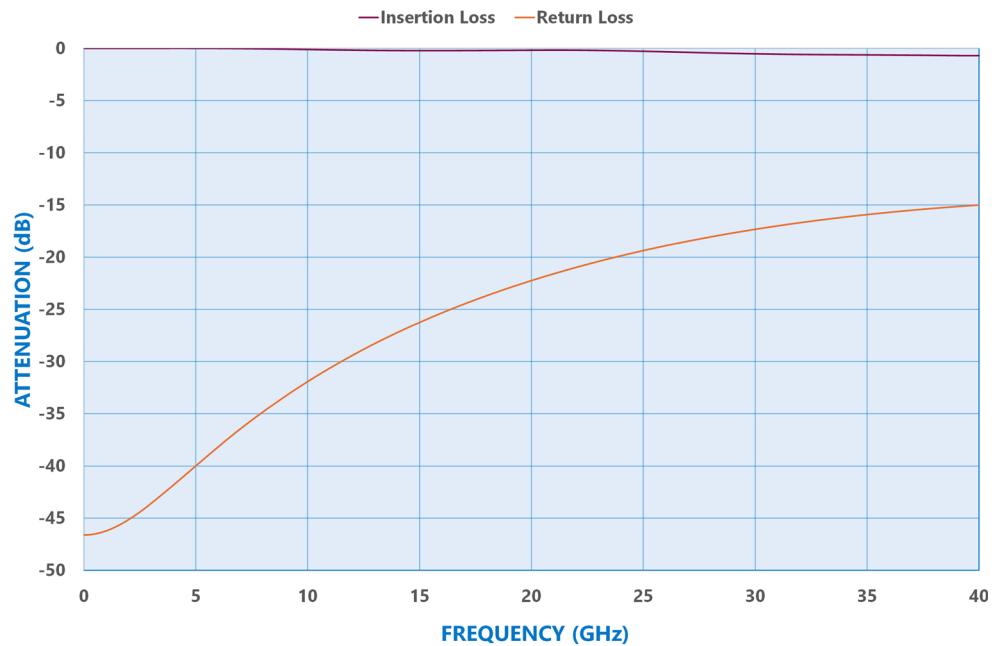

## AXIAL INSERTION LOSS 0.130 [3.30] HEIGHT

Axial Misalignment occurs when the board to board tolerance changes from the minimum working height of the coax to the maximum working height.

The graph (right) shows the Insertion Loss of the EZiCoax as the Axial alignment changes from the Minimum working height in 1 mil. increments

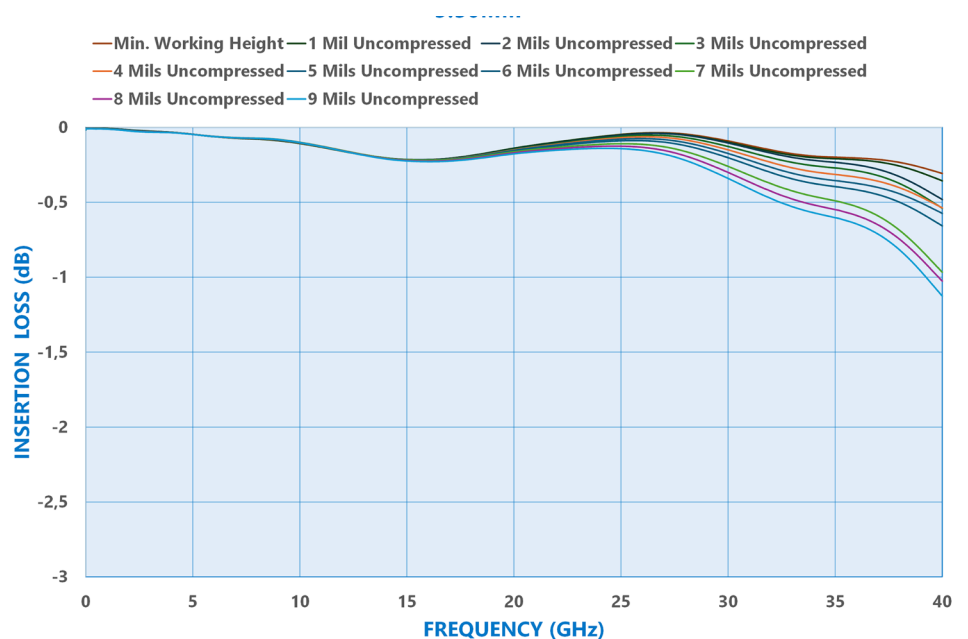

## RADIAL INSERTION LOSS 0.130 [3.30] HEIGHT

Radial Misalignment occurs when the coax deviates from the center of the PCB pad in the X or Y direction.

The graph (right) shows the change in the Insertion Loss as the alignment deviates in 1 mil increments. These results are only valid if using the suggested pad layout.

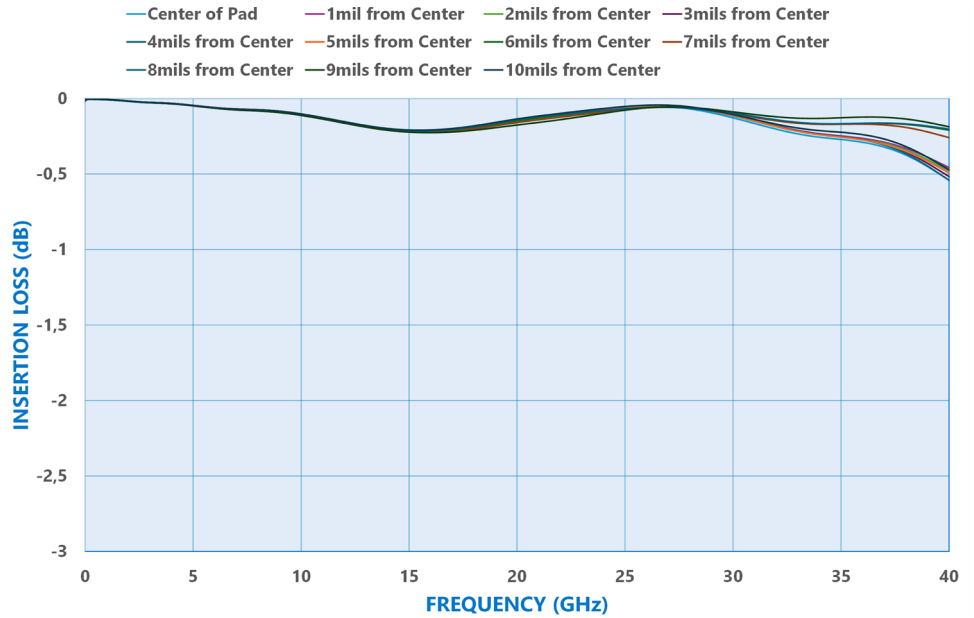

## ANGULAR INSERTION LOSS 0.130 [3.30] HEIGHT

Angular Misalignment occurs when the two PCBs are not parallel to each other.

The graph (right) shows the change in Insertion Loss as the angular alignment changes in half degree increments.

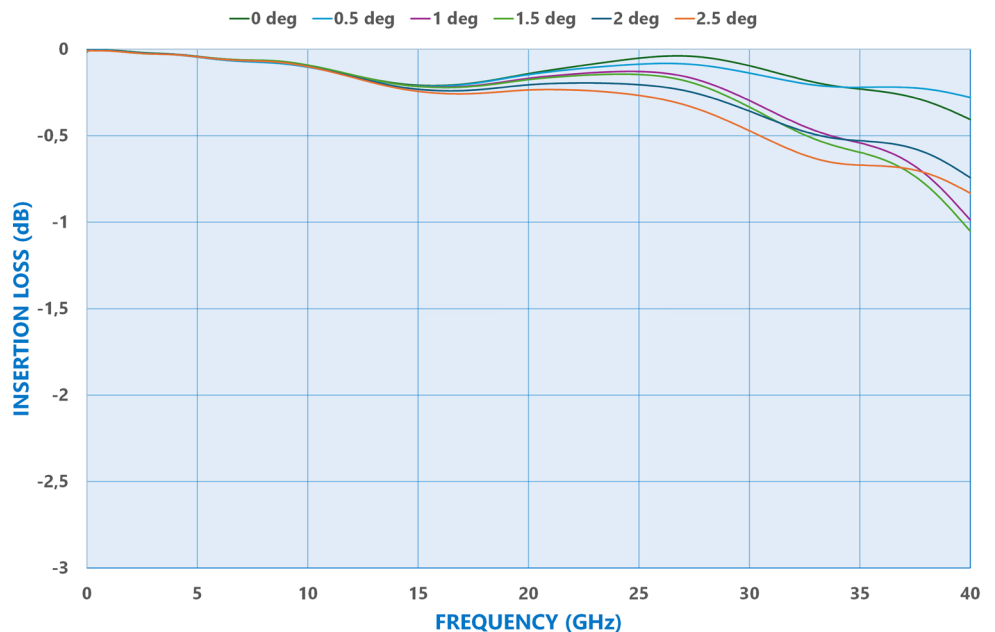

# Standard Interposer Solutions

2-, 4- and 8-ways interposer solutions are available

Smiths Interconnect Interposer solutions configured in 2-, 4-, and 8-way architectures, are equipped with EZiCoax probes and deliver powerful advantages for advanced RF systems. These solutions enable scalable signal distribution and compact integration. Our interposers support clean signal routing with minimal loss and excellent impedance control, ensuring the most accurate transmission in high-frequency communication platforms with the lowest ownership costs.

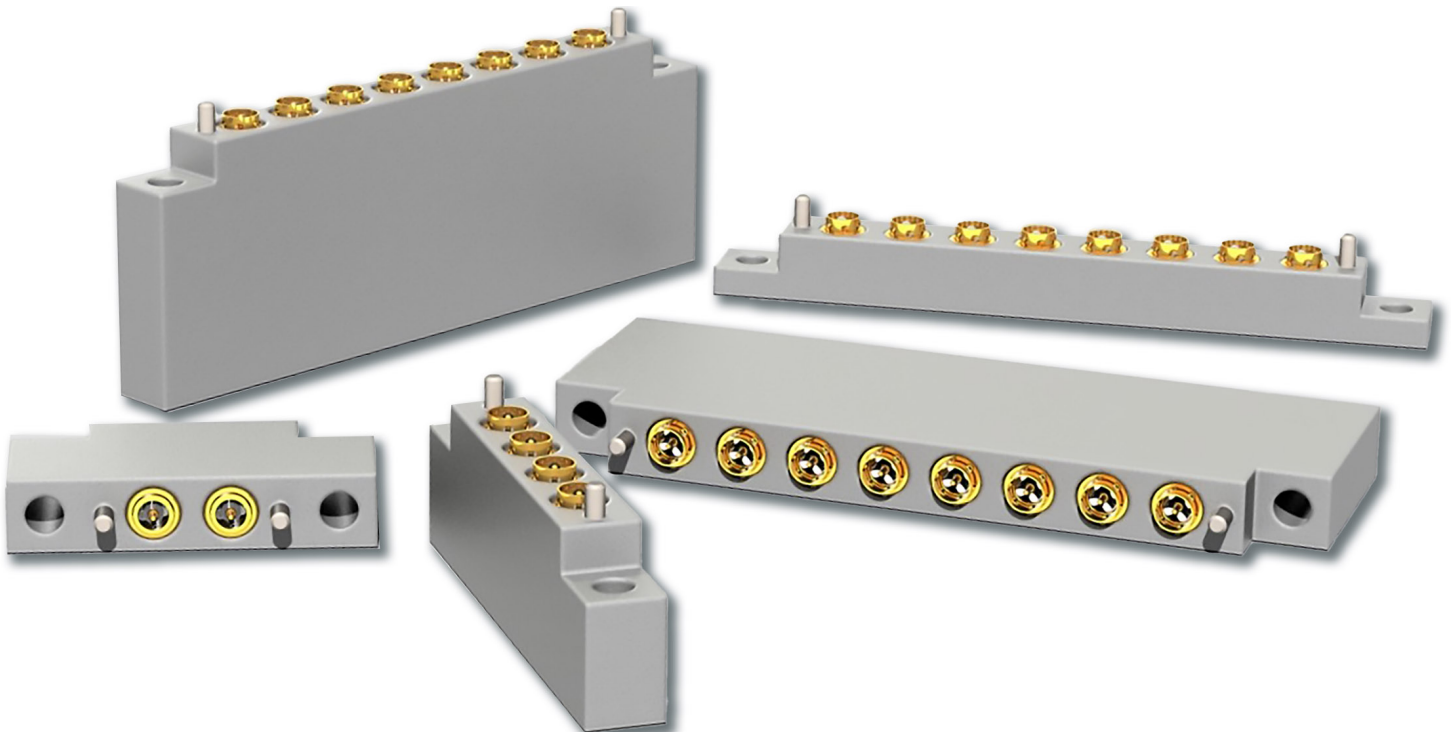

Dimensions are in inches [mm]. Dimensions are for reference only and are subject to change.

# Part Numbers & Dimensions

EZiCoax P/N	2-way Interposer P/N	4-way Interposer P/N	8-way interposer P/N
851-1001909-0130	806-1025190-132	806-1025190-134	806-1025190-138
851-1001909-300	806-1025190-302	806-1025190-304	806-1025190-308
851-1001909-500	806-1025190-502	806-1025190-504	806-1025190-508

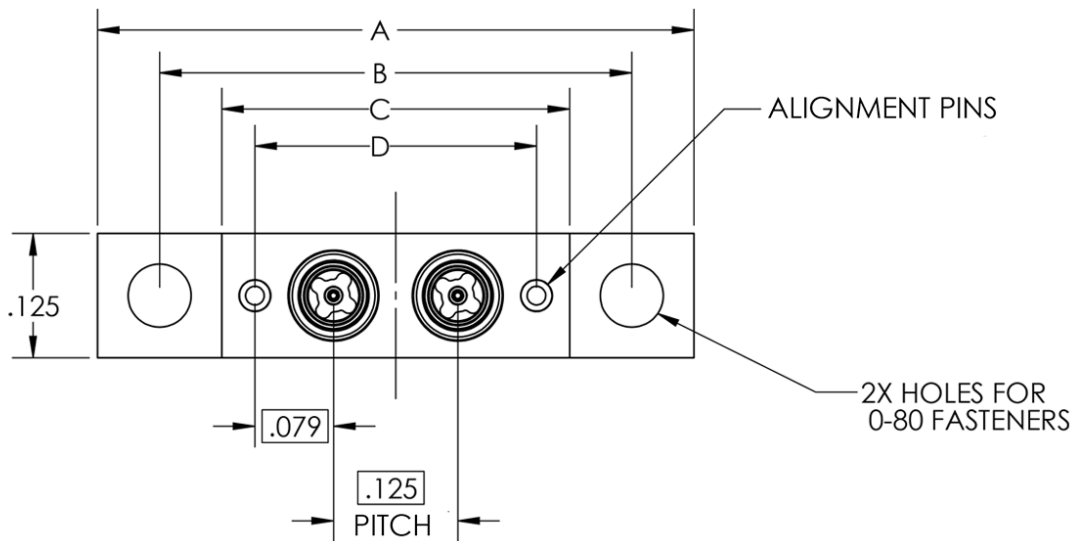

Dimension	2-way Interposer	4-way Interposer	8-way Interposer
<b>A</b>	0.600 [15.24]	0.850 [21.59]	1.350 [34.29]
<b>B</b>	0.475 [12.07]	0.725 [18.42]	1.225 [31.12]
<b>C</b>	0.350 [8.89]	0.600 [15.24]	1.100 [27.94]
<b>D</b>	0.283 [7.19]	0.533 [13.54]	1.033 [26.24]

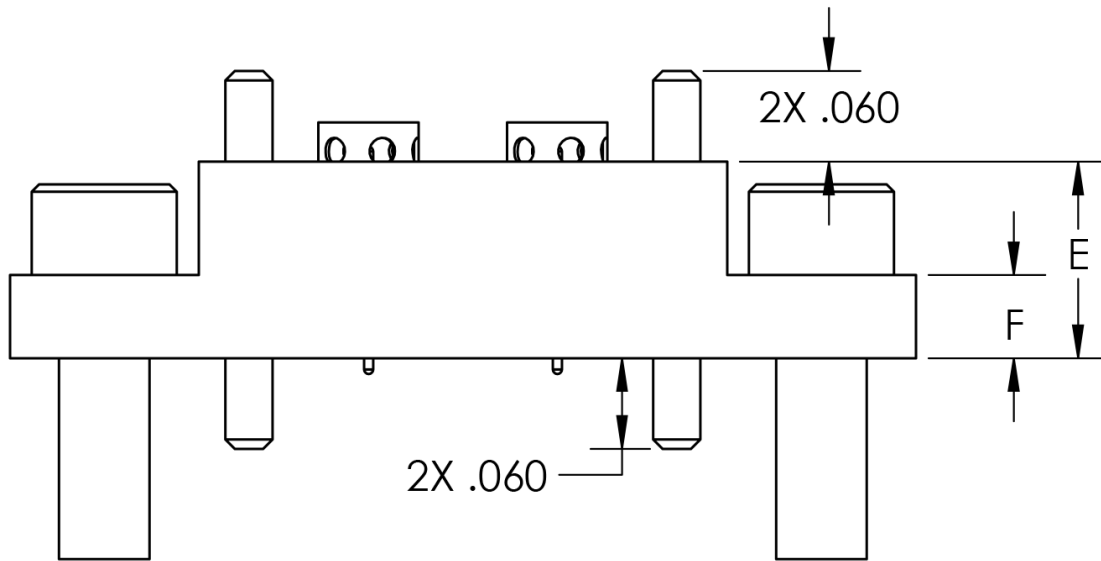

Fasteners shown for reference only

Dimension	-0130 EziCoax	-300 EziCoax	-500 EziCoax
<b>E</b>	0.130 [3.30]	0.272 [6.91]	0.470 [11.94]
<b>F</b>	0.055 [1.40]	0.199 [5.05]	0.395 [10.03]

# 2-, 4- and 8-ways interposers PCB Layouts

## Bottom PCB Layout

Design per IPC 6012 Class 2  
Minimum Copper thickness - 1 oz. Copper  
PCB Plating Finish - ENIPIG

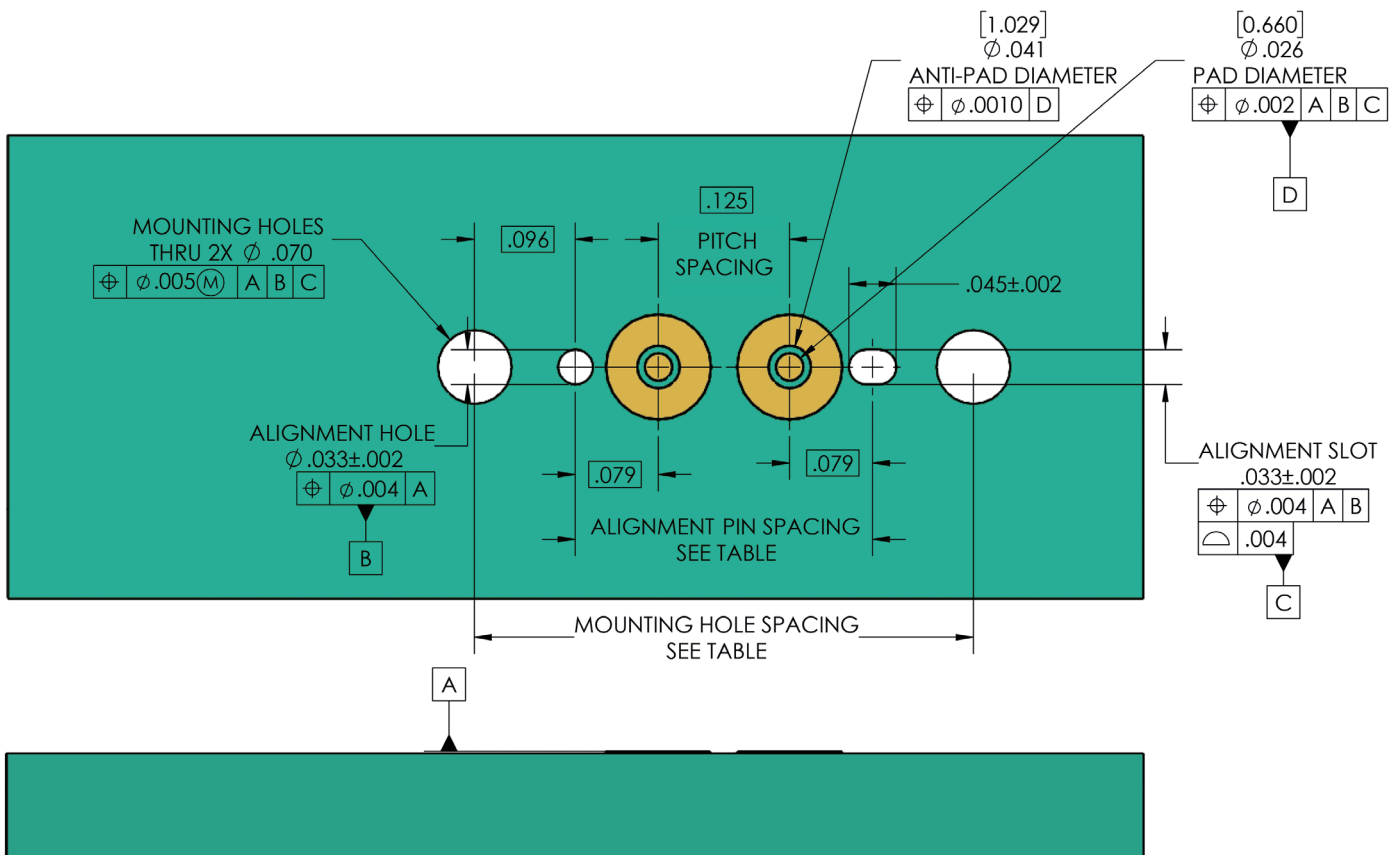

EZiCoax Count	Alignment Pin Spacing	Mounting Hole Spacing
2-way Interposer	0.283 [7.19]	0.486 [12.34]
4-way Interposer	0.534 [13.56]	0.721 [18.31]
8-way Interposer	1.032 [26.21]	1.216 [30.89]

Dimensions are in inches [mm]. Dimensions are for reference only and are subject to change.

## Top PCB layout

Design per IPC 6012 Class 2  
Minimum Copper thickness - 1 oz. Copper  
PCB Plating Finish - ENIPIG

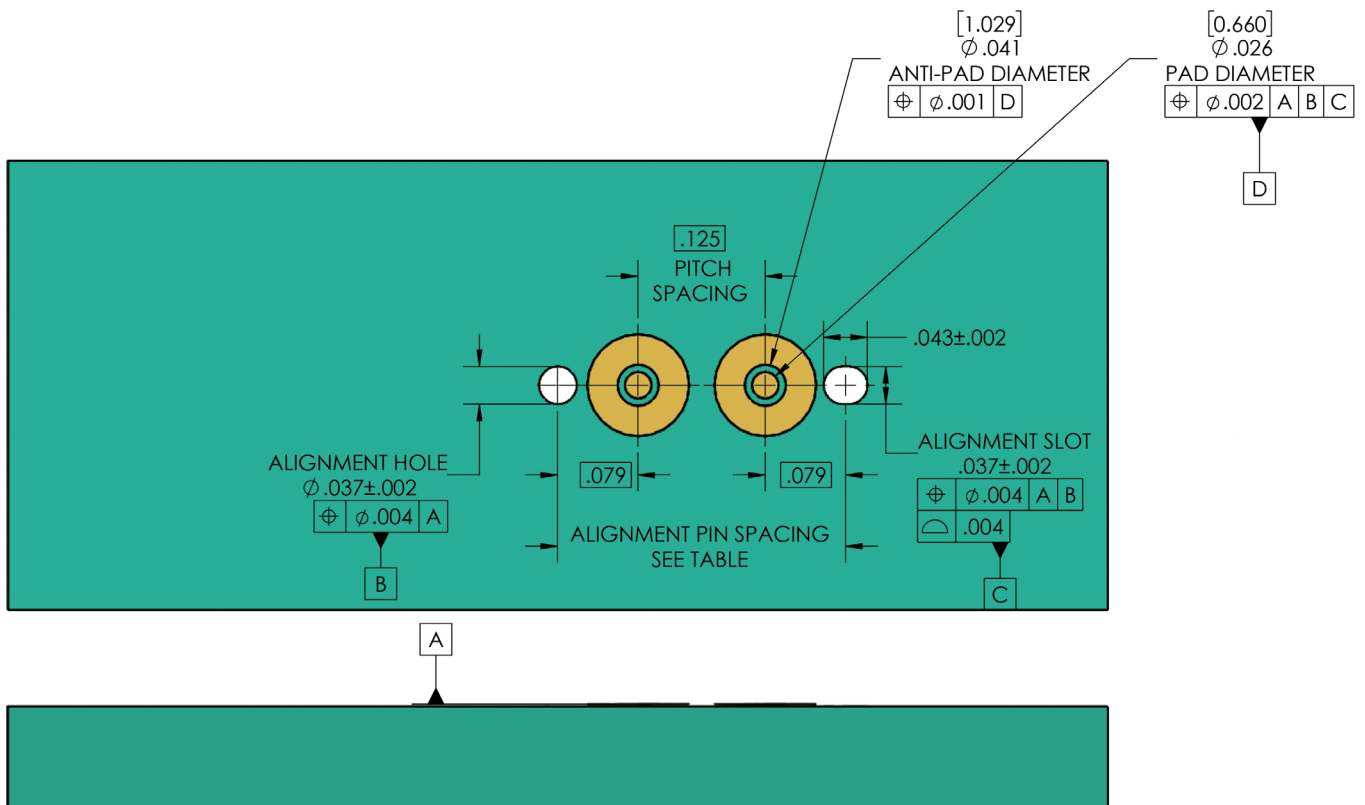

EZiCoax Count	Alignment Pin Spacing
2-way Interposer	0.283 [7.19]
4-way Interposer	0.534 [13.56]
8-way Interposer	1.032 [26.21]

Dimensions are in inches [mm]. Dimensions are for reference only and are subject to change.

## Disclaimer

All of the information included in this catalogue is believed to be accurate at the time of printing. It is recommended, however, that users should independently evaluate the suitability of each product for their intended application and be sure that each product is properly installed, used and maintained to achieve desired results. Smiths Interconnect makes no warranties as to the accuracy or completeness of the information, and disclaims any liability regarding its use.

Smiths Interconnect, a Molex company, reserves the right to modify design and specifications, in order to improve quality, keep pace with technological development or meet specific production requirements.

No reproduction or use without express permission of editorial and pictorial content, in any manner

# Worldwide Support

---

## Connectors

### Americas

#### Sales

connectors.uscsr@smithsinterconnect.com

#### Technical Support

connectors.ustechsupport@smithsinterconnect.com

### Europe

#### Sales

connectors.emeacsr@smithsinterconnect.com

#### Technical Support

connectors.emeatechsupport@smithsinterconnect.com

### Asia

#### Sales

asiacsr@smithsinterconnect.com

#### Technical Support

asiatechsupport@smithsinterconnect.com

---

## Fiber Optics & RF Components

### Americas

#### Sales

focom.uscsr@smithsinterconnect.com

#### Technical Support

focom.techsupport@smithsinterconnect.com

### Europe

#### Sales

focom.emeacsr@smithsinterconnect.com

#### Technical Support

focom.techsupport@smithsinterconnect.com

### Asia

#### Sales

focom.asiacsr@smithsinterconnect.com

#### Technical Support

focom.techsupport@smithsinterconnect.com

---

## Semiconductor Test

### Americas

#### Sales

semi.uscsr@smithsinterconnect.com

#### Technical Support

semi.techsupport@smithsinterconnect.com

### Europe

#### Sales

semi.emeacsr@smithsinterconnect.com

#### Technical Support

semi.techsupport@smithsinterconnect.com

### Asia

#### Sales

semi.asiacsr@smithsinterconnect.com

#### Technical Support

semi.techsupport@smithsinterconnect.com

---

# Connecting Global Markets

smithsinterconnect.com

