

# TS06 Series

ATTENUATOR CHIP DC-20GHZ

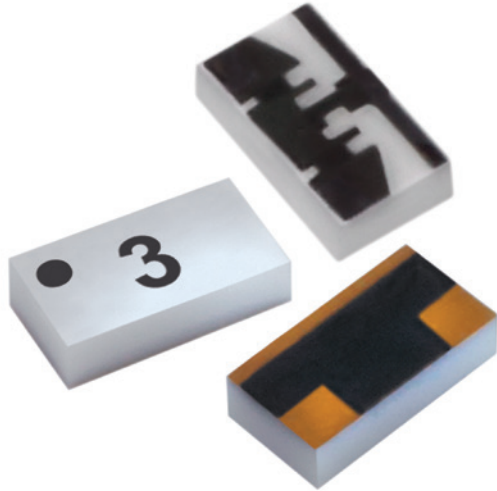

Smiths Interconnect is the world leader in chip attenuators offering the widest selection of products from DC through Q band. Chip components are offered on Alumina, Aluminum Nitride, Beryllium Oxide, and CVD Diamond for a wide range of applications. Backed by proven performance and significant heritage, Smiths Interconnect is the leader in high reliability components.

The TS06 platform offers best in class performance from DC-20 GHz in a small package size. Rated for DC-20 GHz with excellent broadband response, the TS06 series of products has a wide range of applications. It is constructed on an Alumina substrate with rugged thin film terminations and passivated Tantalum Nitride resistive elements. The product also includes a protective coating for added protection from various environmental conditions. Multiple attenuation values and surface finishes are available for RoHS and tin lead solder applications.

TS06 Series Chip Attenuators offers best in class performance from DC-20 GHz in a small package size.

## Features and Benefits

- Small Footprint
- Multiple Terminal Finishes
- Broad Frequency Range
- Low VSWR
- Wide Range of Attenuation Values
- Tight Attenuation Tolerance

## Applications

- Amplifier Circuits
- Transmit/Receive Modules
- Up/Down Converters
- Instrumentation
- Satellite Communications
- Radar
- Broadcast

# Technical Characteristics

Mounting Configuration Options	Planar
--------------------------------	--------

## Electrical

Nominal Impedance	50 ohms					
Frequency Range	DC -20 GHz					
Attenuation Values Available	0-12, 15 & 20 dB in 1 dB Increments					
Attenuation Accuracy	<b>ATTENUATION ACCURACY (dB)</b>					
	Attenuation Value (dB)	DC-10 GHz		10-20 GHz		
	0	Continuity Only				
	1-9	± 0.50		± 0.50		
	10-20	± 0.75		± 1.00		
Input Power CW	<b>INPUT POWER (CW)</b>					
	dB	Watts	dB	Watts	dB	Watts
	0-1	3.0	2-3	1.0	4-20	0.5
Peak Power	10X CW power based on 1 µS pulse width @ 1% Duty Cycle					
VSWR	DC-10GHz 1.25:1 Max, 10-20GHz 1.35:1 Max					

## Environmental

Operating Temperature	-55°C to +150°C
Storage Temperature	-65°C to +150°C
Temperature Coefficient	± 200 PPM/°C Max
Moisture Sensitivity Level	MSL 1 - Unlimited

## Mechanical

Substrate Material	Alumina (Al <sub>2</sub> O <sub>3</sub> ) 96%
Resistive Film	Thin Film, Tantalum Nitride
Terminal Material	Thin Film, Solderable Gold over Nickel
Protective Coating	Silicon Nitride
Finish Options	Blank
	-F Solder Plated (Sn60/Pb40)
	-F Silver Plated (RoHS Compliant)
	-S Pretinned (Sn60/Pb40)

## Marking

Unit Marking	Orientation dot and dB Value
--------------	------------------------------

## Quality Assurance

	Sample visual and mechanical inspection - 1.0 AQL per mechanical drawing requirements. Periodic electrical inspection performed for commercial grade products. High reliability tested products are available per MIL-PRF-55342.
--	--

## Packaging

Standard Packaging	Tape and Reel or Waffle Pack
--------------------	------------------------------

# Power Derating Curve

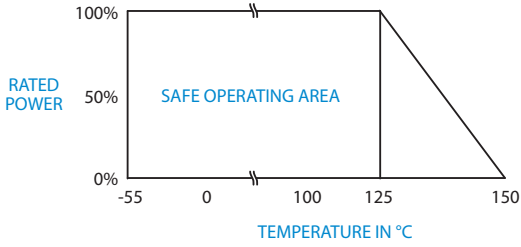

# Typical Data

## TS06XX Series Attenuation

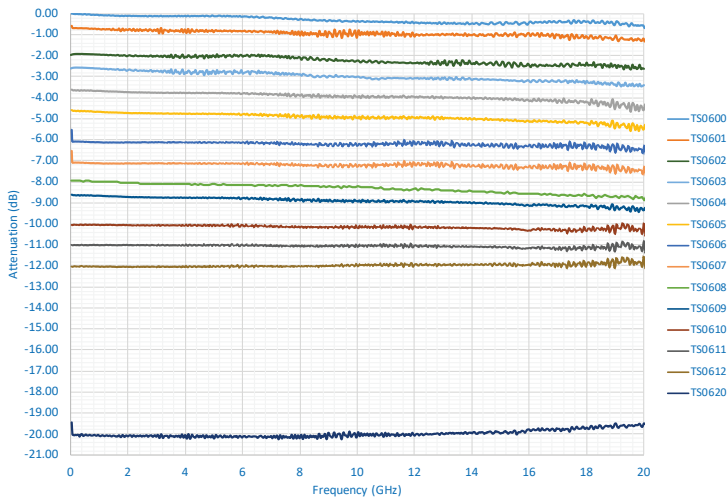

# Mechanical

## TT5XXX - Planar Option

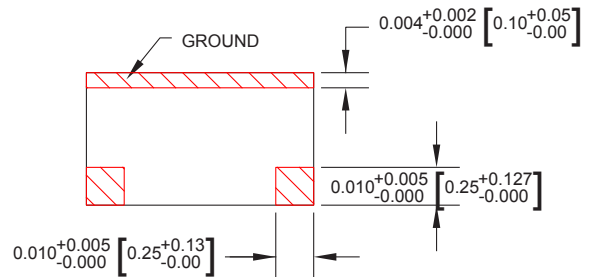
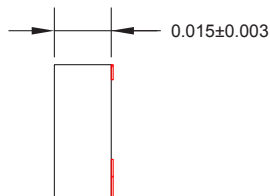
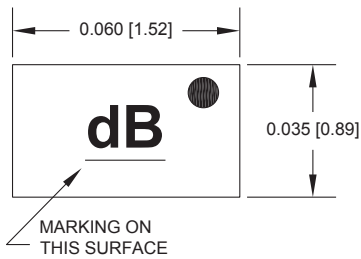

Unless otherwise specified, tolerance: X.XXX = ±0.005"

# Suggested Mounting Footprint

Part Number	Inches						Millimeters					
	A	B	C	D	S	W	A	B	C	D	S	W
TS06xxF	0.018	0.018	0.033	0.020	0.016	0.068	0.46	0.46	0.84	0.51	0.41	1.73

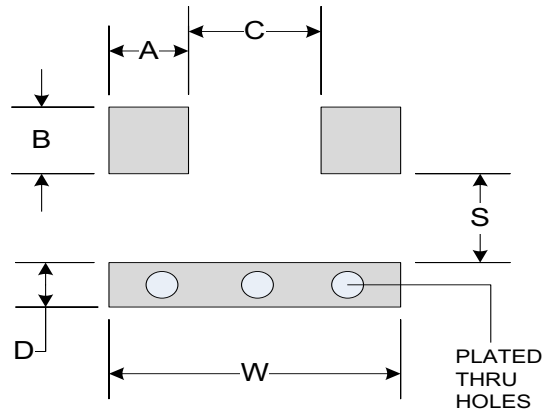

## How To Order

Specify Model Number: **TS06XXX**

<div style="display: flex; justify-content: space-around;"> <div style="text-align: center;"> <span style="border: 1px solid black; padding: 2px;">T S 0 6</span> 1                 </div> <div style="text-align: center;"> <span style="border: 1px solid black; padding: 2px;">  </span> 2                 </div> <div style="text-align: center;"> <span style="border: 1px solid black; padding: 2px;">  </span> 3                 </div> </div>	
<b>1 Series Name</b>	<span style="border: 1px solid black; padding: 2px;">T S 0 6</span> Series
<b>2 Attenuation Value</b>	<span style="border: 1px solid black; padding: 2px;">0 0</span> 00 dB through 12.0 dB <span style="margin-left: 20px;"><span style="border: 1px solid black; padding: 2px;">1 5</span> 15.0 dB</span> <span style="margin-left: 20px;"><span style="border: 1px solid black; padding: 2px;">2 0</span> 20.0 dB</span>
<b>3 Terminal Finish</b>	<span style="border: 1px solid black; padding: 2px;">  </span> Standard <span style="margin-left: 20px;"><span style="border: 1px solid black; padding: 2px;">S</span> Pretinning</span> <span style="margin-left: 20px;"><span style="border: 1px solid black; padding: 2px;">F</span> RoHS</span>

# Global Support

## Americas

- Costa Mesa, CA  
+1 714 371 1100  
info.us@smithsinterconnect.com
- Milpitas, CA  
+1 408 957 9607 x-1125  
info.us@smithsinterconnect.com
- Stuart, FL  
+1 772 286 9300  
info.us@smithsinterconnect.com
- Kirkland, QC, Canada  
+1 514 842 5179  
info.us@smithsinterconnect.com
- Hudson, MA  
+1 978 568 0451  
info.us@smithsinterconnect.com
- Northampton, MA  
+1 413 582 9620  
info.northampton@smithsinterconnectinc.com
- Tampa, FL  
+ 1 813 901 7200  
info.tampa@smithsinterconnectinc.com
- Kansas City, KS  
+1 913 342 5544  
info.us@smithsinterconnect.com
- Salisbury, MD  
+1 800 780 2169  
info.us@smithsinterconnect.com
- Thousand Oaks, CA  
+1 805 267 0100  
info.thousandoaks@smithsinterconnectinc.com

## Europe

- Deggendorf, Germany  
+49 991 250 120  
info.de@smithsinterconnect.com
- Genova, Italy  
+39 0 10 60361  
info.it@smithsinterconnect.com
- Dundee, UK  
+44 1382 427 200  
info.dundee@smithsinterconnect.com
- Rouen, France  
+33 2 32 96 91 76  
info.fr@smithsinterconnect.com
- Elstree, UK  
+44 20 8236 2400  
info.uk@smithsinterconnect.com

## Asia

- Bangalore, India  
+91 080 4241 0529  
info.in@smithsinterconnect.com
- Singapore  
+65 6846 1655  
info.asia@smithsinterconnect.com
- Mianyang, China  
+86 816 231 5566  
HSICSR@hf-smiths.com
- Suzhou, China  
+86 512 6273 1188  
info.asia@smithsinterconnect.com
- Shanghai, China  
+86 21 3318 4650  
info.asia@smithsinterconnect.com

more > [smithsinterconnect.com](https://www.smithsinterconnect.com) | [in](#) [twitter](#) [youtube](#)