

# K Series

Medium & High Density PCB Connectors

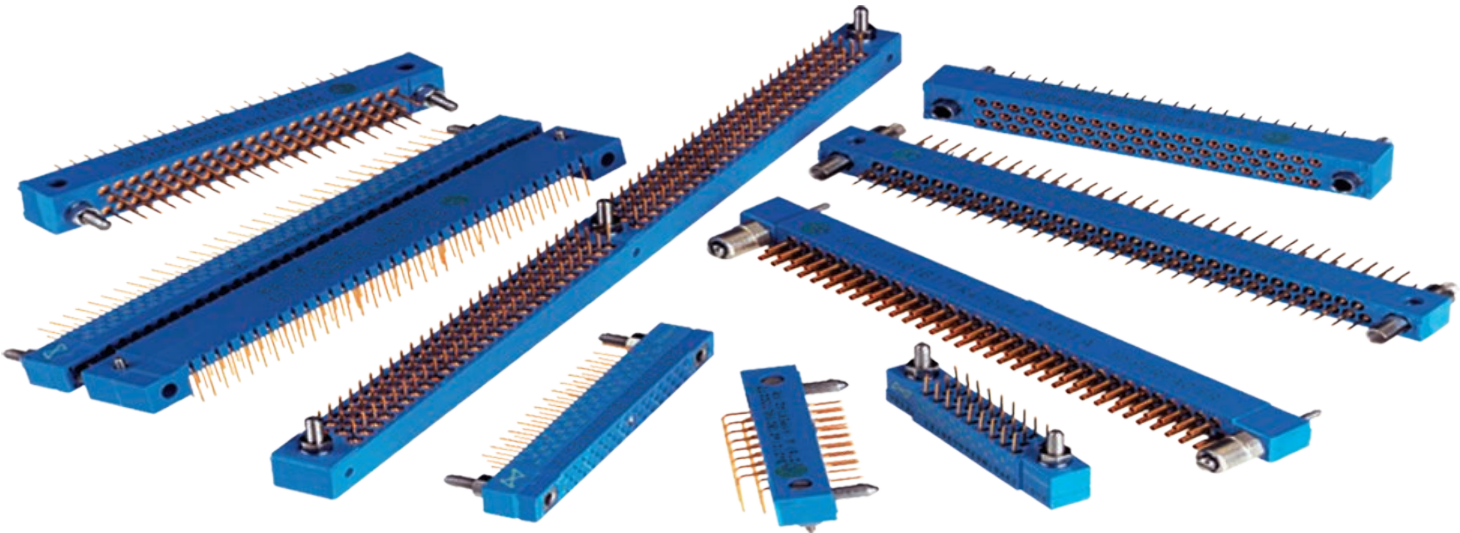

# Hypertac<sup>®</sup> Hyperboloid Technology

Smiths Interconnect offers an extensive range of superior contact technologies suitable for standard and custom solutions. Hypertac<sup>®</sup> (HYPERboloid conTACT) is the original superior performing hyperboloid contact technology designed for use in all applications and in harsh and demanding environments where high reliability and safety are critical. The inherent electrical and mechanical characteristics of the Hypertac hyperboloid contact ensures unrivalled performance in terms of reliability, number of mating cycles, low contact force and minimal contact resistance. The shape of the contact sleeve is formed by hyperbolically arranged contact wires, which align themselves elastically as contact lines around the pin, providing a number of linear contact paths.

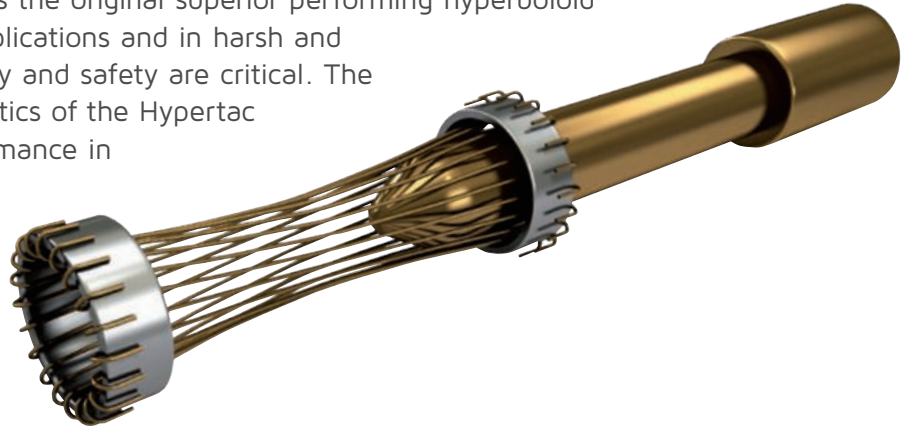

## Features

### Low insertion/extraction forces

The angle of the socket wires allows tight control of the pin insertion and extraction forces. The spring wires are smoothly deflected to make line contact with the pin.

### Long contact life

The smooth and light wiping action minimizes wear on the contact surfaces. Contacts perform up to 100,000 insertion/extraction cycles with minimal degradation in performance.

### Lower contact resistance

The design provides a far greater contact area and the wiping action of the wires insures a clean and polished contact surface. Our contact technology has about half the resistance of conventional contact designs.

### Higher current ratings

The design parameters of the contact (e.g., the number, diameter and angle of the wires) may be modified for any requirement. The number of wires can be increased so the contact area is distributed over a larger surface. Thus, the high current carried by each wire because of its intimate line contact, can be multiplied many times.

### Immunity to shock & vibration

The low mass and resultant low inertia of the wires enable them to follow the most abrupt or extreme excursions of the pin without loss of contact. The contact area extends 360° around the pin and is uniform over its entire length. The 3 dimensional symmetry of the Hypertac contact design guarantees electrical continuity in all circumstances.

## Benefits

### High density interconnect systems

Significant reductions in size and weight of sub-system designs. No additional hardware is required to overcome mating and unmating forces.

### Low cost of ownership

The Hypertac contact technology will surpass most product requirements, thus eliminating the burden and cost of having to replace the connector or the entire subsystem.

### Low power consumption

The lower contact resistance of our technology results in a lower voltage drop across the connector reducing the power consumption and heat generation within the system.

### Maximum contact performance

The lower contact resistance of the Hypertac contact reduces heat build-up; therefore Hypertac contacts are able to handle far greater current in smaller contact assemblies without the detrimental effects of high temperature.

### Reliability under harsh environments

Harsh environmental conditions require connectors that will sustain their electrical integrity even under the most demanding conditions such as shock and vibration. The Hypertac contact provides unmatched stability in demanding environments when failure is not an option.

# Contents

## KN Series - Medium Density PCB Connectors

KNB series (2 rows).....	2
KXB series (2 rows).....	18
KNC/KND series (3 rows) .....	21
Contacts.....	36
Tools and accessories.....	37

## KM Series - High Density PCB Connectors

KMC Series (3 rows) .....	40
KMH Series (3 rows).....	62
Power & High Frequency Contacts .....	66
Tools and accessories.....	67

# Technical Characteristics

Contact diameter	HYPERTAC® type Ø 0.60 mm rear removable
Number of contact	Up to 120
Pitch	2.54 mm between rows - 1.27 mm between quicuncial contacts
Rows	2

## Materials & Platings

Contact	Brass or bronze	
Molding	Glass fiber filled diallyl - Phtalate	
Guides	Stainless steel or nickel plated brass	
	<b>Standard</b>	<b>ESA</b>
Pin body	0.25 µm gold / 1.27 µm Ni	1.27 µm gold / 1.27 µm Ni (min.)
Socket body	0.25 µm gold / 1.27 µm Ni on active area 1.27 µm Ni on non active area	0.25 µm gold / 1.27 µm Ni (min.)
Socket wires	1 µm gold / 0.20 µm Ni	1.27 µm gold / 0.20 µm Ni (min.)

## Electrical

Current grade rating (at 25°C)	Standard grade: 3 A max. - ESA grade: 5 A max.
Dielectric withstanding voltage	1200 Vrms
Contact resistance	≤8 mΩ
Insulation resistance	>104 MΩ (500 Vcc)

## Mechanical

Mating & unmating cycle	5000
Guiding	By two outside guides (2 guiding styles) and one central guide (3 guiding styles)
Keying	By rotating of outside polarized guides (up to 36 keying)

## Environmental

Temperature range	-55° C to 125° C
Conformity	MIL C 55302, ESA/ESCC3401/016 - 3401/017, NF C-UTE C 93-424

# How To Order



1 Series																																																																									
2 Pitch or type	<b>N</b> 1.27 mm pitch, rear removable contacts																																																																								
3 Model	<b>B</b> 2 rows																																																																								
4 Number of contacts	<b>0 1 7 0 2 9 0 4 1 0 5 3 0 6 5 0 7 2 0 8 4 0 9 6 1 2 0</b> For the right angle 053 layout, KNB must be replaced by KXB (non ESA qualified, details on page 20)																																																																								
5 Molding polarity	<table border="1"> <thead> <tr> <th colspan="4">NF C-UTE C 93-424 MIL-C-55302 ESA/ESCC 3401/01601B SPACE GRADE</th> <th colspan="4">NF C-UTE C 93-424 MIL-C-55302 ESA/ESCC 3401/01601B SPACE GRADE</th> <th colspan="4">NF C-UTE C 93-424 MIL-C-55302 ESA/ESCC 3401/01601B SPACE GRADE</th> </tr> </thead> <tbody> <tr> <td>12</td><td>14</td><td>54</td><td>54</td> <td>1A</td><td>1C</td><td>-</td><td>5A</td> <td>26</td><td>28</td><td>-</td><td>46</td> <td>Female plug</td> <td>Tinned female plug**</td> <td>Tinned female receptacle*</td> </tr> <tr> <td>13</td><td>15</td><td>55</td><td>55</td> <td>1B</td><td>1D</td><td>-</td><td>5B</td> <td>27</td><td>29</td><td>-</td><td>47</td> <td>Male plug</td> <td>Tinned male plug**</td> <td>Tinned male receptacle*</td> </tr> <tr> <td>16</td><td>18</td><td>-</td><td>56</td> <td>22</td><td>24</td><td>44</td><td>44</td> <td>2A</td><td>2C</td><td>-</td><td>-</td> <td>Tinned female plug*</td> <td>Female receptacle</td> <td>Tinned female receptacle**</td> </tr> <tr> <td>17</td><td>19</td><td>-</td><td>57</td> <td>23</td><td>25</td><td>45</td><td>45</td> <td>2B</td><td>2D</td><td>-</td><td>-</td> <td>Tinned male plug*</td> <td>Male receptacle</td> <td>Tinned male receptacle**</td> </tr> </tbody> </table>	NF C-UTE C 93-424 MIL-C-55302 ESA/ESCC 3401/01601B SPACE GRADE				NF C-UTE C 93-424 MIL-C-55302 ESA/ESCC 3401/01601B SPACE GRADE				NF C-UTE C 93-424 MIL-C-55302 ESA/ESCC 3401/01601B SPACE GRADE				12	14	54	54	1A	1C	-	5A	26	28	-	46	Female plug	Tinned female plug**	Tinned female receptacle*	13	15	55	55	1B	1D	-	5B	27	29	-	47	Male plug	Tinned male plug**	Tinned male receptacle*	16	18	-	56	22	24	44	44	2A	2C	-	-	Tinned female plug*	Female receptacle	Tinned female receptacle**	17	19	-	57	23	25	45	45	2B	2D	-	-	Tinned male plug*	Male receptacle	Tinned male receptacle**
NF C-UTE C 93-424 MIL-C-55302 ESA/ESCC 3401/01601B SPACE GRADE				NF C-UTE C 93-424 MIL-C-55302 ESA/ESCC 3401/01601B SPACE GRADE				NF C-UTE C 93-424 MIL-C-55302 ESA/ESCC 3401/01601B SPACE GRADE																																																																	
12	14	54	54	1A	1C	-	5A	26	28	-	46	Female plug	Tinned female plug**	Tinned female receptacle*																																																											
13	15	55	55	1B	1D	-	5B	27	29	-	47	Male plug	Tinned male plug**	Tinned male receptacle*																																																											
16	18	-	56	22	24	44	44	2A	2C	-	-	Tinned female plug*	Female receptacle	Tinned female receptacle**																																																											
17	19	-	57	23	25	45	45	2B	2D	-	-	Tinned male plug*	Male receptacle	Tinned male receptacle**																																																											
6 Termination styles	<table border="1"> <tbody> <tr> <td>10</td> <td>Through board solder - 90° - length 3 mm</td> <td>21</td> <td>Double crimp</td> <td>51</td> <td>Wire wrap (3 wrapping levels)</td> </tr> <tr> <td>11</td> <td>Through board solder - 90° - length 4 mm</td> <td>30</td> <td>Through board solder - straight</td> <td>91</td> <td>Female - male</td> </tr> <tr> <td>20</td> <td>Crimp</td> <td>40</td> <td>Solder bucket</td> <td></td> <td></td> </tr> </tbody> </table>	10	Through board solder - 90° - length 3 mm	21	Double crimp	51	Wire wrap (3 wrapping levels)	11	Through board solder - 90° - length 4 mm	30	Through board solder - straight	91	Female - male	20	Crimp	40	Solder bucket																																																								
10	Through board solder - 90° - length 3 mm	21	Double crimp	51	Wire wrap (3 wrapping levels)																																																																				
11	Through board solder - 90° - length 4 mm	30	Through board solder - straight	91	Female - male																																																																				
20	Crimp	40	Solder bucket																																																																						
7 Mounting hardware	<p><b>Guide Style (consult us for special guides)</b></p> <table border="1"> <tbody> <tr> <td>110</td> <td>Male polarized, transverse mount, standard plug</td> <td>145</td> <td>Male polarized, transverse mount on receptacle only</td> <td>131</td> <td>Male unpolarized, transverse mount</td> </tr> <tr> <td>111</td> <td>Male polarized, vertical mount</td> <td>190</td> <td>Female power or mass contact, vertical mount</td> <td>132</td> <td>Female unpolarized, transverse mount</td> </tr> <tr> <td>113</td> <td>Male polarized, float mount</td> <td>125</td> <td>Male unpolarized, transverse mount</td> <td>133</td> <td>Female all polarized, transverse mount</td> </tr> <tr> <td>121</td> <td>Female polarized, vertical mount</td> <td>126</td> <td>Female unpolarized, vertical mount</td> <td>191</td> <td>Male power or mass contact, vertical mount</td> </tr> <tr> <td>123</td> <td>Female polarized, float mount</td> <td>127</td> <td>Male unpolarized, vertical mount</td> <td></td> <td></td> </tr> <tr> <td>124</td> <td>Female polarized, transverse mount</td> <td>130</td> <td>Female unpolarized, vertical mount</td> <td></td> <td></td> </tr> </tbody> </table> <p><b>Locking Styles</b></p> <table border="1"> <thead> <tr> <th colspan="2">MALE PLUG</th> <th colspan="2">FEMALE RECEPTACLE</th> </tr> </thead> <tbody> <tr> <td>201</td> <td>1/4 turn, free connector</td> <td>202</td> <td>1/4 turn, vertical mount</td> </tr> <tr> <td>203</td> <td>1/4 turn, transverse mount</td> <td>204</td> <td>1/4 turn, transverse mount</td> </tr> <tr> <td>207</td> <td>Jackscrew, free connector</td> <td>208</td> <td>Jackscrew, transverse mount</td> </tr> <tr> <td>211</td> <td>Jackscrew, free connector</td> <td>210</td> <td>Jackscrew, free connector</td> </tr> <tr> <td>290</td> <td>Jackscrew, vertical mount</td> <td>212</td> <td>Jackscrew, transverse mount</td> </tr> <tr> <td></td> <td></td> <td>215</td> <td>Jackscrew, vertical mount</td> </tr> <tr> <td></td> <td></td> <td>219</td> <td>Jackscrew, vertical mount</td> </tr> <tr> <td></td> <td></td> <td>232</td> <td>Jackscrew, with operation button</td> </tr> </tbody> </table>	110	Male polarized, transverse mount, standard plug	145	Male polarized, transverse mount on receptacle only	131	Male unpolarized, transverse mount	111	Male polarized, vertical mount	190	Female power or mass contact, vertical mount	132	Female unpolarized, transverse mount	113	Male polarized, float mount	125	Male unpolarized, transverse mount	133	Female all polarized, transverse mount	121	Female polarized, vertical mount	126	Female unpolarized, vertical mount	191	Male power or mass contact, vertical mount	123	Female polarized, float mount	127	Male unpolarized, vertical mount			124	Female polarized, transverse mount	130	Female unpolarized, vertical mount			MALE PLUG		FEMALE RECEPTACLE		201	1/4 turn, free connector	202	1/4 turn, vertical mount	203	1/4 turn, transverse mount	204	1/4 turn, transverse mount	207	Jackscrew, free connector	208	Jackscrew, transverse mount	211	Jackscrew, free connector	210	Jackscrew, free connector	290	Jackscrew, vertical mount	212	Jackscrew, transverse mount			215	Jackscrew, vertical mount			219	Jackscrew, vertical mount			232	Jackscrew, with operation button
110	Male polarized, transverse mount, standard plug	145	Male polarized, transverse mount on receptacle only	131	Male unpolarized, transverse mount																																																																				
111	Male polarized, vertical mount	190	Female power or mass contact, vertical mount	132	Female unpolarized, transverse mount																																																																				
113	Male polarized, float mount	125	Male unpolarized, transverse mount	133	Female all polarized, transverse mount																																																																				
121	Female polarized, vertical mount	126	Female unpolarized, vertical mount	191	Male power or mass contact, vertical mount																																																																				
123	Female polarized, float mount	127	Male unpolarized, vertical mount																																																																						
124	Female polarized, transverse mount	130	Female unpolarized, vertical mount																																																																						
MALE PLUG		FEMALE RECEPTACLE																																																																							
201	1/4 turn, free connector	202	1/4 turn, vertical mount																																																																						
203	1/4 turn, transverse mount	204	1/4 turn, transverse mount																																																																						
207	Jackscrew, free connector	208	Jackscrew, transverse mount																																																																						
211	Jackscrew, free connector	210	Jackscrew, free connector																																																																						
290	Jackscrew, vertical mount	212	Jackscrew, transverse mount																																																																						
		215	Jackscrew, vertical mount																																																																						
		219	Jackscrew, vertical mount																																																																						
		232	Jackscrew, with operation button																																																																						

\* For 90° & straight terminations (splicing on PCB)  
 \*\* RoHS compliant for 90° & straight terminations (splicing on PCB)

# Hypertac & ESA Correspondence Table

**HYPERTAC** **KNB**

34 01 016 01 B

1

2

3

4

5

6

<p><b>1</b> ESCC component number</p>																																																																																																				
<p><b>2</b> Mounting</p>	<table border="1"> <thead> <tr> <th colspan="4">HYPERTAC</th> <th colspan="4">ESA</th> </tr> </thead> <tbody> <tr> <td>Plug KNB 017</td><td>01</td> <td>Plug KNB 096</td><td>08</td> <td>Receptacle KNB 053</td><td>16</td> <td>Plug KNB 072</td><td>56</td> <td>Plug KNC 098</td><td>62</td> </tr> <tr> <td>Plug KNB 029</td><td>02</td> <td>Plug KNB 120</td><td>10</td> <td>Receptacle KNB 065</td><td>17</td> <td>Receptacle KNB 072</td><td>57</td> <td>Receptacle KNC 098</td><td>63</td> </tr> <tr> <td>Plug KNB 041</td><td>03</td> <td>Plug KNC 160</td><td>12</td> <td>Receptacle KNB 084</td><td>19</td> <td>Plug KNC 062</td><td>58</td> <td></td><td></td> </tr> <tr> <td>Plug KNB 053</td><td>04</td> <td>Receptacle KNB 017</td><td>13</td> <td>Receptacle KNB 096</td><td>20</td> <td>Receptacle KNC 062</td><td>59</td> <td></td><td></td> </tr> <tr> <td>Plug KNB 065</td><td>05</td> <td>Receptacle KNB 029</td><td>14</td> <td>Receptacle KNB 120</td><td>22</td> <td>Plug KNC 080</td><td>60</td> <td></td><td></td> </tr> <tr> <td>Plug KNB 084</td><td>07</td> <td>Receptacle KNB 041</td><td>15</td> <td>Receptacle KNC 160</td><td>24</td> <td>Receptacle KNC 080</td><td>61</td> <td></td><td></td> </tr> </tbody> </table> <table border="1"> <tr> <td colspan="4">REMINDER SPATIAL P.P.P. (Party Polarity Protection)</td> <td colspan="4">EXAMPLE</td> </tr> <tr> <td>Female receptacle</td><td>44</td> <td>Plug female</td><td>54</td> <td colspan="4">KNB 029 <b>44</b> 40 113</td> </tr> <tr> <td>Male receptacle</td><td>45</td> <td>Plug male</td><td>55</td> <td colspan="4">P.P.P. <input type="checkbox"/></td> </tr> </table>								HYPERTAC				ESA				Plug KNB 017	01	Plug KNB 096	08	Receptacle KNB 053	16	Plug KNB 072	56	Plug KNC 098	62	Plug KNB 029	02	Plug KNB 120	10	Receptacle KNB 065	17	Receptacle KNB 072	57	Receptacle KNC 098	63	Plug KNB 041	03	Plug KNC 160	12	Receptacle KNB 084	19	Plug KNC 062	58			Plug KNB 053	04	Receptacle KNB 017	13	Receptacle KNB 096	20	Receptacle KNC 062	59			Plug KNB 065	05	Receptacle KNB 029	14	Receptacle KNB 120	22	Plug KNC 080	60			Plug KNB 084	07	Receptacle KNB 041	15	Receptacle KNC 160	24	Receptacle KNC 080	61			REMINDER SPATIAL P.P.P. (Party Polarity Protection)				EXAMPLE				Female receptacle	44	Plug female	54	KNB 029 <b>44</b> 40 113				Male receptacle	45	Plug male	55	P.P.P. <input type="checkbox"/>			
HYPERTAC				ESA																																																																																																
Plug KNB 017	01	Plug KNB 096	08	Receptacle KNB 053	16	Plug KNB 072	56	Plug KNC 098	62																																																																																											
Plug KNB 029	02	Plug KNB 120	10	Receptacle KNB 065	17	Receptacle KNB 072	57	Receptacle KNC 098	63																																																																																											
Plug KNB 041	03	Plug KNC 160	12	Receptacle KNB 084	19	Plug KNC 062	58																																																																																													
Plug KNB 053	04	Receptacle KNB 017	13	Receptacle KNB 096	20	Receptacle KNC 062	59																																																																																													
Plug KNB 065	05	Receptacle KNB 029	14	Receptacle KNB 120	22	Plug KNC 080	60																																																																																													
Plug KNB 084	07	Receptacle KNB 041	15	Receptacle KNC 160	24	Receptacle KNC 080	61																																																																																													
REMINDER SPATIAL P.P.P. (Party Polarity Protection)				EXAMPLE																																																																																																
Female receptacle	44	Plug female	54	KNB 029 <b>44</b> 40 113																																																																																																
Male receptacle	45	Plug male	55	P.P.P. <input type="checkbox"/>																																																																																																
<p><b>3</b> Termination style</p>	<table border="1"> <thead> <tr> <th colspan="4">HYPERTAC</th> <th colspan="4">ESA</th> </tr> </thead> <tbody> <tr> <td>Bent male 10</td><td>MC</td> <td>Solder bucket male 40</td><td>MS</td> <td>Crimp female 20</td><td>FR</td> <td colspan="2">Female-male 91</td><td>FM</td> </tr> <tr> <td>Bent long male 11</td><td>ML</td> <td>Mini-wrapping male 51</td><td>MY</td> <td>Straight female 30</td><td>FD</td> <td colspan="3"></td> </tr> <tr> <td>Crimp male 20</td><td>MR</td> <td>Bent female 10</td><td>FC</td> <td>Solder bucket female 40</td><td>FS</td> <td colspan="3"></td> </tr> <tr> <td>Straight male 30</td><td>MD</td> <td>Bent long female 11</td><td>FL</td> <td>Mini-wrapping female 51</td><td>FY</td> <td colspan="3"></td> </tr> </tbody> </table>								HYPERTAC				ESA				Bent male 10	MC	Solder bucket male 40	MS	Crimp female 20	FR	Female-male 91		FM	Bent long male 11	ML	Mini-wrapping male 51	MY	Straight female 30	FD				Crimp male 20	MR	Bent female 10	FC	Solder bucket female 40	FS				Straight male 30	MD	Bent long female 11	FL	Mini-wrapping female 51	FY																																																			
HYPERTAC				ESA																																																																																																
Bent male 10	MC	Solder bucket male 40	MS	Crimp female 20	FR	Female-male 91		FM																																																																																												
Bent long male 11	ML	Mini-wrapping male 51	MY	Straight female 30	FD																																																																																															
Crimp male 20	MR	Bent female 10	FC	Solder bucket female 40	FS																																																																																															
Straight male 30	MD	Bent long female 11	FL	Mini-wrapping female 51	FY																																																																																															
<p><b>4</b> Locking type On left side</p>	<table border="1"> <thead> <tr> <th colspan="4">HYPERTAC</th> <th colspan="4">ESA</th> </tr> </thead> <tbody> <tr> <td>Guideless connector</td><td>00</td> <td>KNB 145</td><td>40</td> <td>KNC 10 209</td><td>49</td> <td>KNB 11 125</td><td>71</td> <td>KNB 11 208</td><td>79</td> </tr> <tr> <td>KNB 131</td><td>31</td> <td>KNB 124</td><td>41</td> <td>KN 210</td><td>50</td> <td>KNB 11 110</td><td>72</td> <td>KN 219</td><td>80</td> </tr> <tr> <td>KNB 132</td><td>32</td> <td>KNC 10 230</td><td>43</td> <td>KN 211</td><td>51</td> <td>KNB 10 230</td><td>73</td> <td>KN 290*</td><td>81</td> </tr> <tr> <td>KNB 10 110</td><td>33</td> <td>KN 232</td><td>45</td> <td>KNB 212</td><td>52</td> <td>KNC 124</td><td>74</td> <td></td><td></td> </tr> <tr> <td>KNC 10 110</td><td>34</td> <td>KN 231</td><td>46</td> <td>KN 215</td><td>53</td> <td>KNC 132</td><td>75</td> <td></td><td></td> </tr> <tr> <td>KN 111</td><td>35</td> <td>KN 207</td><td>47</td> <td>KN 123</td><td>54</td> <td>KNC 11 110</td><td>76</td> <td></td><td></td> </tr> <tr> <td>KN 121</td><td>36</td> <td>KNB 10 208</td><td>48</td> <td>KN 113</td><td>55</td> <td>KNC 11 125</td><td>77</td> <td></td><td></td> </tr> </tbody> </table>								HYPERTAC				ESA				Guideless connector	00	KNB 145	40	KNC 10 209	49	KNB 11 125	71	KNB 11 208	79	KNB 131	31	KNB 124	41	KN 210	50	KNB 11 110	72	KN 219	80	KNB 132	32	KNC 10 230	43	KN 211	51	KNB 10 230	73	KN 290*	81	KNB 10 110	33	KN 232	45	KNB 212	52	KNC 124	74			KNC 10 110	34	KN 231	46	KN 215	53	KNC 132	75			KN 111	35	KN 207	47	KN 123	54	KNC 11 110	76			KN 121	36	KNB 10 208	48	KN 113	55	KNC 11 125	77																
HYPERTAC				ESA																																																																																																
Guideless connector	00	KNB 145	40	KNC 10 209	49	KNB 11 125	71	KNB 11 208	79																																																																																											
KNB 131	31	KNB 124	41	KN 210	50	KNB 11 110	72	KN 219	80																																																																																											
KNB 132	32	KNC 10 230	43	KN 211	51	KNB 10 230	73	KN 290*	81																																																																																											
KNB 10 110	33	KN 232	45	KNB 212	52	KNC 124	74																																																																																													
KNC 10 110	34	KN 231	46	KN 215	53	KNC 132	75																																																																																													
KN 111	35	KN 207	47	KN 123	54	KNC 11 110	76																																																																																													
KN 121	36	KNB 10 208	48	KN 113	55	KNC 11 125	77																																																																																													
<p><b>5</b> Locking type In center</p>	<p><b>0 0</b> For 2 guide connectors</p> <p><b>- -</b> For 3 guide connectors (see table 4, Locking type - On left side)</p> <table border="1"> <thead> <tr> <th colspan="4">HYPERTAC</th> <th colspan="4">ESA</th> </tr> </thead> <tbody> <tr> <td>KNB 10 125</td><td>26</td> <td>KNC 10 125</td><td>27</td> <td>KN 127</td><td>28</td> <td>KN 126</td><td>29</td> <td></td><td></td> </tr> </tbody> </table>								HYPERTAC				ESA				KNB 10 125	26	KNC 10 125	27	KN 127	28	KN 126	29																																																																												
HYPERTAC				ESA																																																																																																
KNB 10 125	26	KNC 10 125	27	KN 127	28	KN 126	29																																																																																													
<p><b>6</b> Locking type On right side</p>	<p>(see table 4, Locking type - On left side)</p>																																																																																																			

\* Please consult us

# Contact Terminations

## Plug

Male

Female

## Receptacle

Female

Male

90° Through board solder

Ref: **10** (X=3) Ref : **MC & FC** - Ref: **11** (X=4) Ref : **ML & FL**

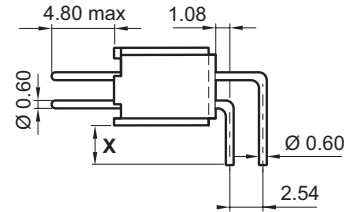
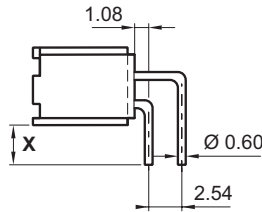
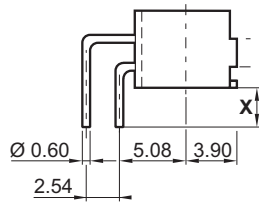
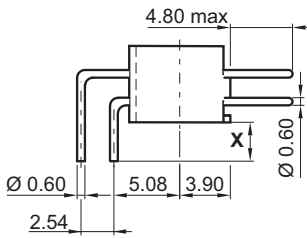

## Crimp (AWG 28-26 & 24-22)

Ref: **20** Ref : **MR & FR**

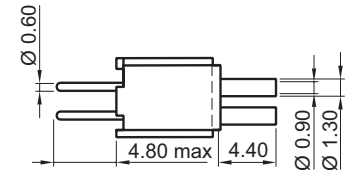
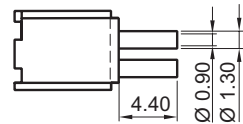
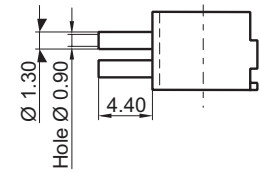
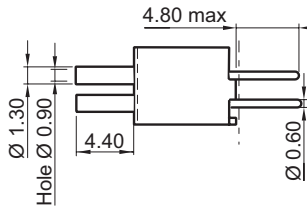

## Crimp (AWG 28-26 & 24-22) & Crimp on sheath (Ø 1.45)

Ref: **21**

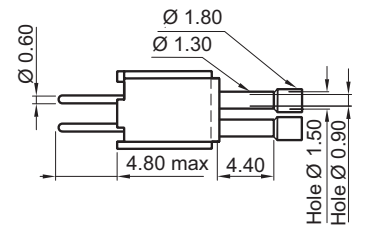
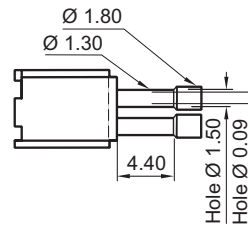
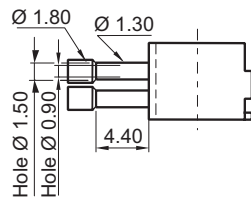
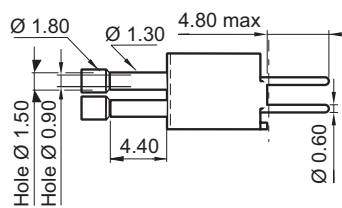

## Straight through board solder

Ref: **30** Ref : **MD & FD** Ref **31**

See: 90° Through board solder

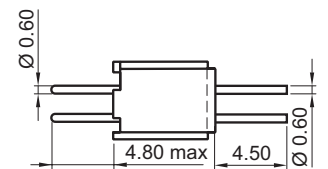
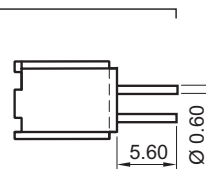
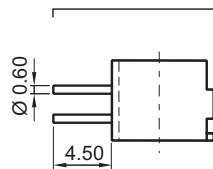
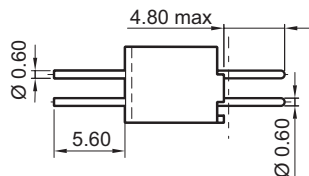

# Contact Terminations

## Plug

Male

Female

Female

Male

Solder bucket (AWG 22 max)

Ref: **40** Ref : **MS & FS**

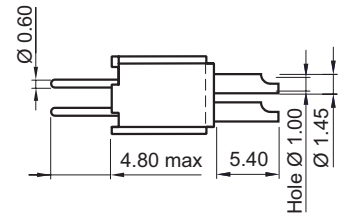
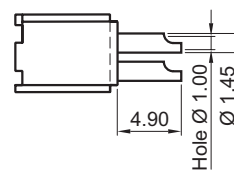
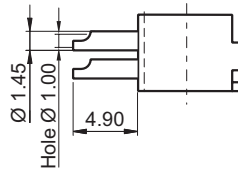
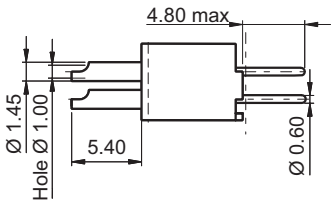

## Wire wrap (3 wrapping levels)

Ref: **51** Ref : **MY & FY**

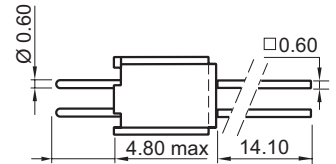
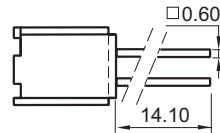
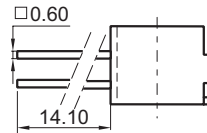
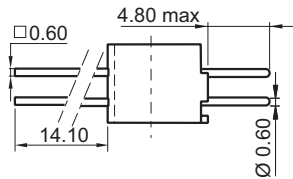

## Saver (male-male)

Ref: **90**

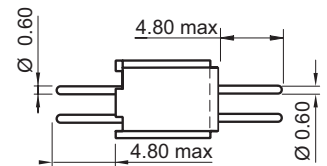
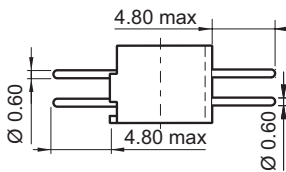

## Saver (female-male)

Ref: **91** Ref : **FM**

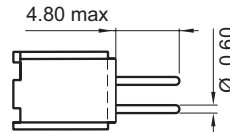
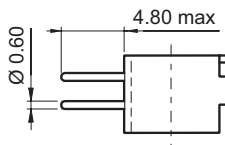



# Connector Dimensions

## Plug

17 to 65 contacts

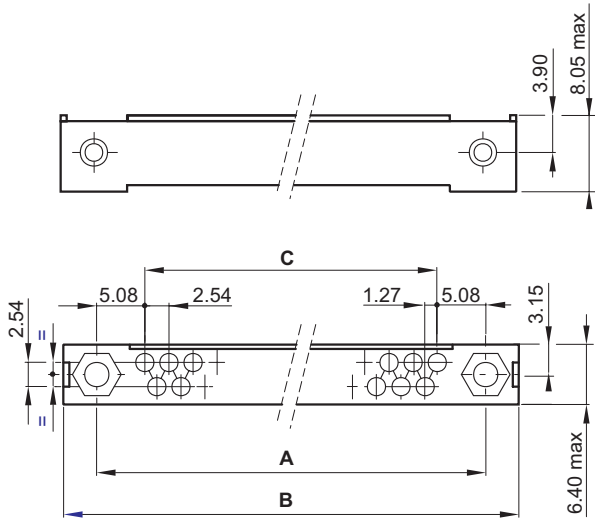

## Receptacle

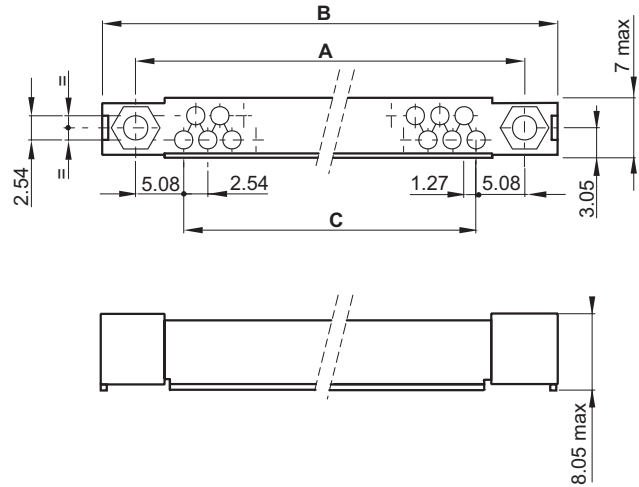

72 to 120 contacts

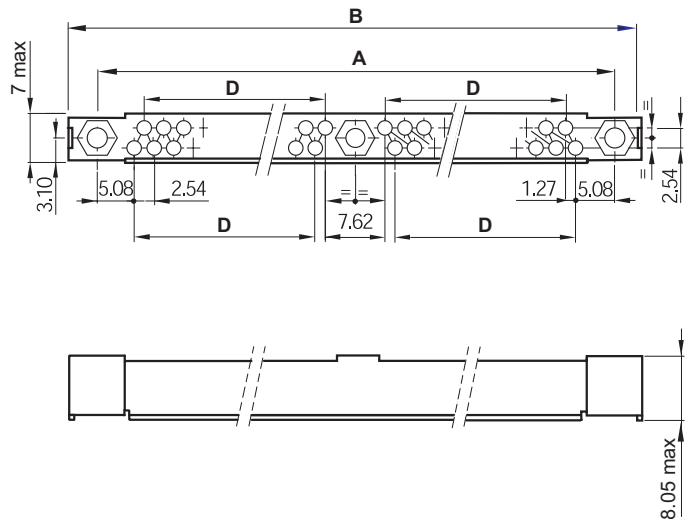
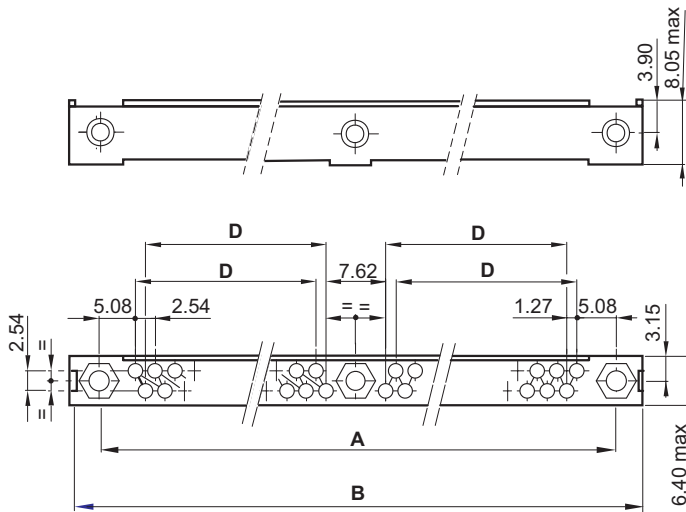

No. of contacts	17	29	41	53	65	72	84	96	120
A	30.48	45.72	60.96	76.20	91.44	106.68	121.92	137.16	167.64
B max	38.50	53.70	69.00	84.20	99.50	114.70	129.90	145.20	175.50
C	20.32	35.56	50.80	66.04	81.28	-	-	-	-
D	-	-	-	-	-	43.18	50.80	58.42	73.66

# Guide Device and Polarity Termination Compatibility Chart

### Legend

- Compatible
- Compatible special saver connector

**FP** = Female Plug

**FR** = Female Receptacle

**MR** = Male Receptacle

														Polarity						
MR 23	FR 22	FP 12	MP 13	MR 23	FR 22	FP 12	MP 13	MR 23	FR 22	FP 12	MP 13	MR 23	FR 22	FP 12	MP 13	Receptacle			Molding	
																Plug				Contact
																90°	10	11		
																Straight	30	31		
																Solder bucket		40		
																Crimp	20	21		
																Wire wrap		51		

Polarity	Receptacle	Plug	90°	Straight	Solder bucket	Crimp	Wire wrap - PPC	190	133	132	130	126	124	123	121	Guiding devices					
																10	11	30	31	40	20
FP 12																				Male guides	
MP 13																					
MR 23																					
FR 22																					Guiding devices
MR 23																					
FR 22																					
FP 12																					
MP 13																					
MR 23																					
FR 22																					
FP 12																					
MP 13																					
MR 23																					
FR 22																					
FP 12																					
MP 13																					
FP 12																					Female guides
MP 13																					

# Guide Styles

## Plug & Receptacle

### Male

#### Polarized vertical mount

Ref: 111 Ref : 35

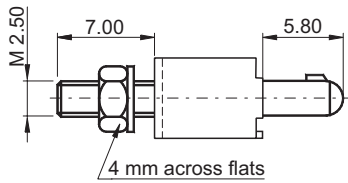

#### Polarized vertical float mount

Ref: 113 Ref : 55

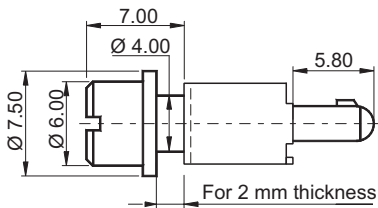

#### Unpolarized vertical mount

Ref: 127 Ref : 28

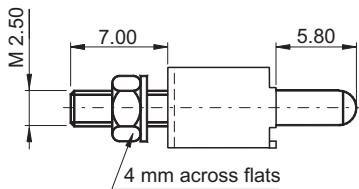

#### Unpolarized transverse mount

Ref: 131 Ref : 31

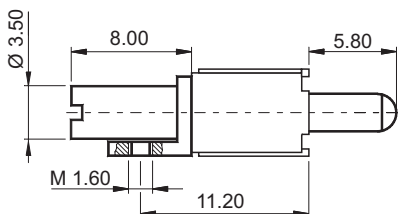

### Female

#### Polarized vertical mount

Ref: 121 Ref : 36

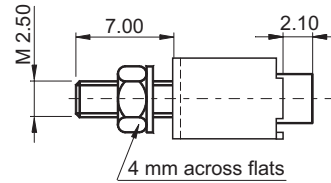

#### Polarized vertical float mount

Ref: 123 Ref : 54

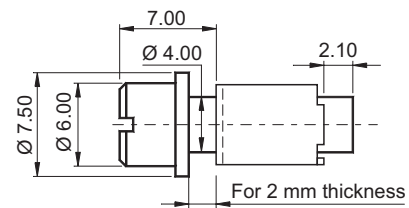

#### Polarized transverse mount

Ref: 124 Ref : 41

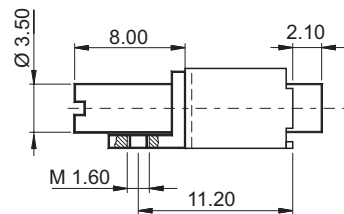

#### Unpolarized vertical mount

Ref: 126 Ref : 29

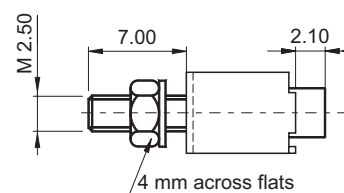

# Guide Styles

## Plug & Receptacle

### Male

#### Polarized transverse mount

Ref: **145** Ref : 40

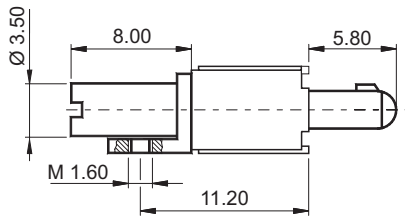

### Female

#### All polarized vertical mount

Ref: **130**

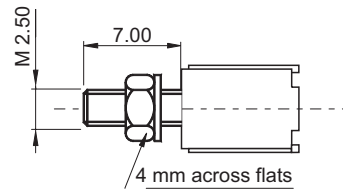

#### Unpolarized transverse mount

Ref: **132** Ref : 32

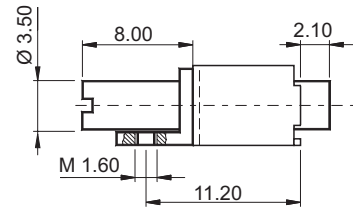

#### All polarized transverse mount

Ref: **133**

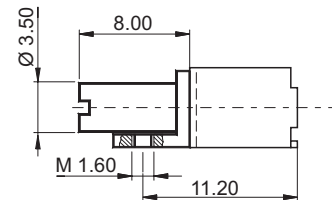

# Guide Styles

## Plug & Receptacle

### Male

#### Power or mass transverse mount

Ref: **191**

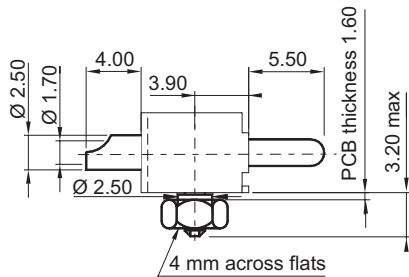

### Female

#### Power or mass vertical mount

Ref: **190**

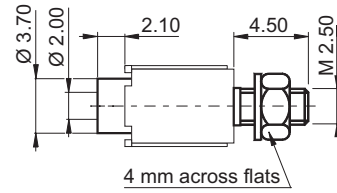

## Male plug only

### Polarized transverse mount

Ref: **10 110** Ref: **33** X=1.60 Y=3.20  
 Ref: **11 110** Ref: **72** X=2.40 Y=4.90

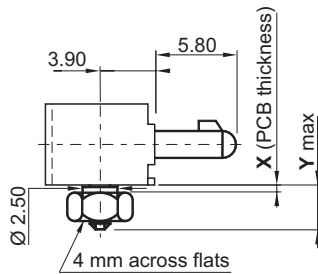

### Unpolarized transverse mount

Ref: **10 125** Ref: **26** X=1.60 Y=3.20  
 Ref: **11 125** Ref: **71** X=2.40 Y=4.90

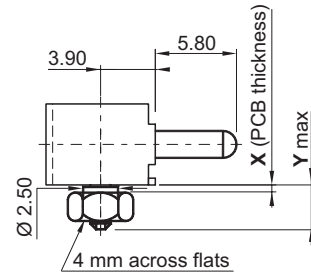

# Locking Device Compatibility Chart

		R	P	R	P	R	P	R	P	R	P	R	P	R	P		
Compatible																Receptacle	Molding
																Plug	
P																	290
R																	
P																	231
R																	
P																	211
R																	
P																	207
R																	
P																	205
R																	
P																	203
R																	
P																	201
R																	
	Receptacle															Male locking devices	
	Plug															Female locking devices	
Molding																	
		232	219	215	212	210	208	204	202								

# Male Locking Styles

## Plug & Receptacle

### Jack 1/4 turn lock, free connector

Ref: **201**

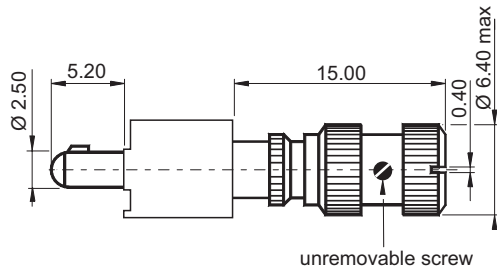

### Jackscrew, free connector

Ref: **211** Ref : **51**

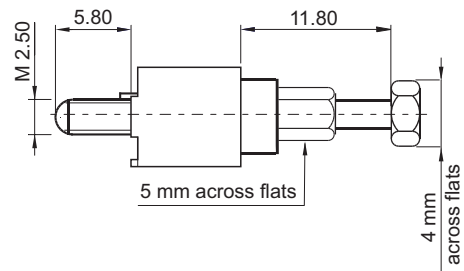

### Jack 1/4 turn lock, transverse mount

Ref: **203** PCB thickness **1.60**

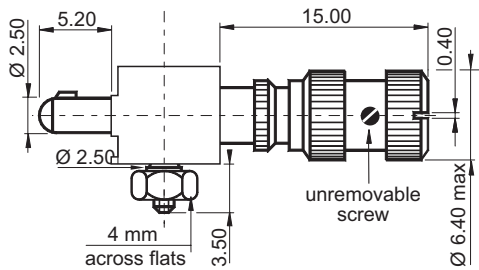

### Jackscrew, vertical mount

Ref: **231** Ref : **46**

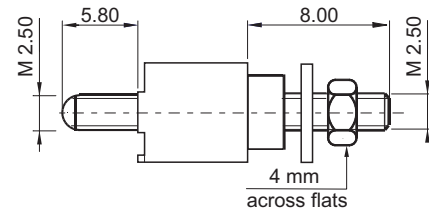

### Jackscrew, free connector

Ref: **207** Ref : **47**

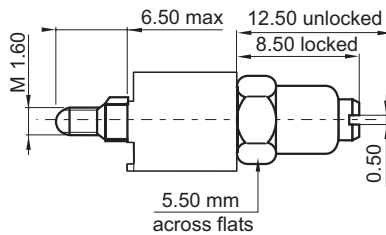

### Jackscrew, vertical mount

Ref: **290** Ref : **81**

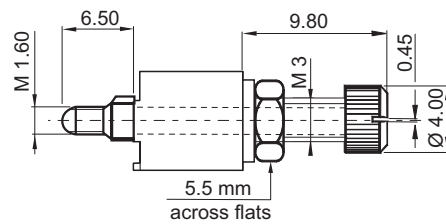

# Female Locking Styles

## Plug & Receptacle

### Jack 1/4 turn lock, vertical mount

Ref: **202**

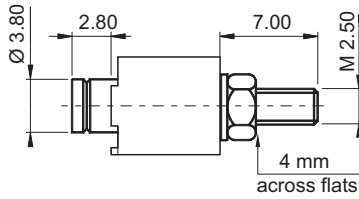

### Jackscrew, transverse mount

Ref: **212** Ref : **52**

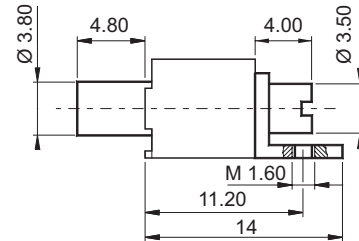

### Jack 1/4 turn lock, transverse mount

Ref: **204**

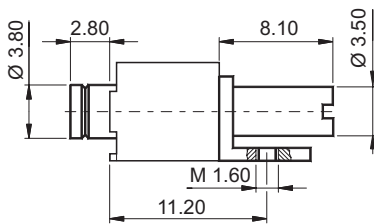

### Jackscrew, vertical mount

Ref: **215** Ref : **53**

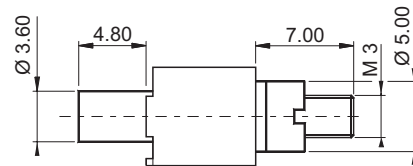

### Jackscrew, transverse mount

Ref: **10 208** Ref : **48** PCB thickness 1.60  
Ref: **11 208** Ref : **79** PCB thickness 2.40

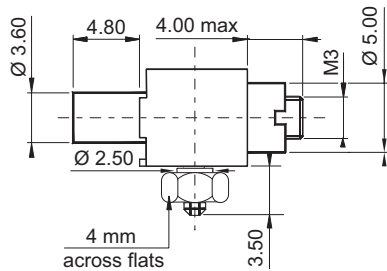

### Jackscrew, vertical mount

Ref: **219** Ref : **80**

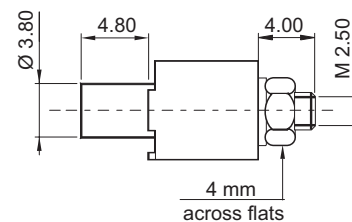

### Jackscrew, free connector

Ref: **210** Ref : **50**

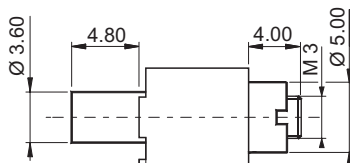

### Rotating jackscrew, free connector

Ref: **232** Ref : **45**

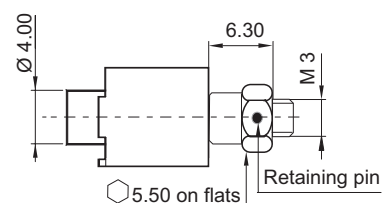



# Mating Side Layout View

## Plug

## Receptacle

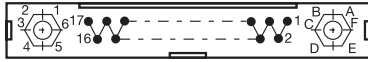

017

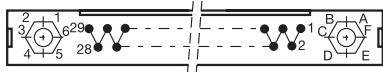
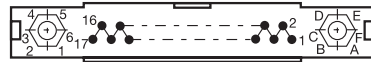

029

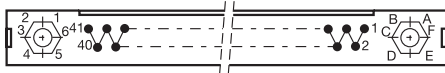
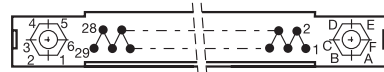

041

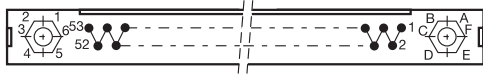
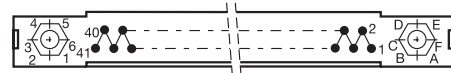

053

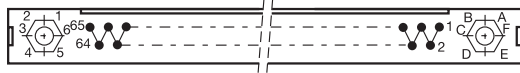
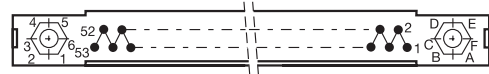

065

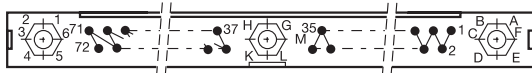
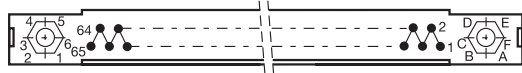

072

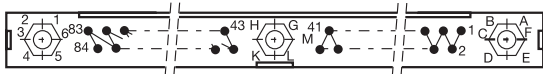
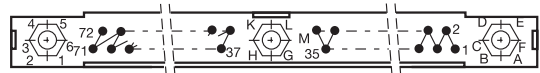

084

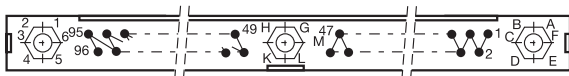
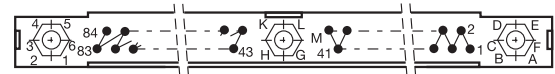

096

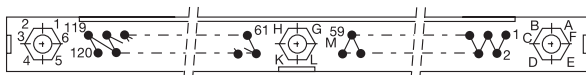

120

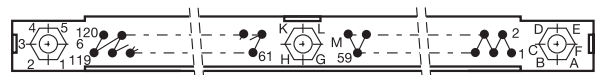

# Panel Preparation Details

## 17 to 65 Contacts

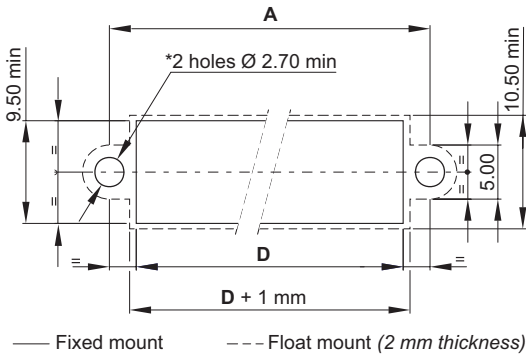

## 72 to 120 Contacts

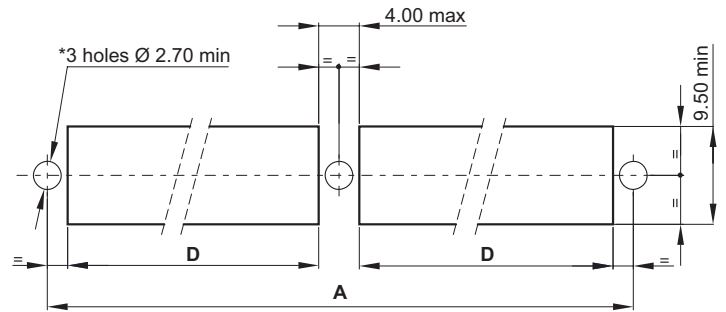

**Panel:** female or male, plug or receptacle, terminations 20 - 40 - 51  
**Guide styles:** 111 - 121 - 126 - 127 - 130 - 190 (Fixed Mount) - 113 - 123 (Float Mount)  
**Locking styles:** 202 - 215\* - 219 - 231  
 \* for ref: 215, holes  $\varnothing$  3.20 mm

No. of contacts	17	29	41	53	65	72	84	96	120
A	30.48	45.72	60.96	76.20	91.44	106.68	121.92	137.16	167.64
D	25.90	41.10	56.40	71.60	86.90	48.50	56.00	63.30	78.80

# Board Preparation Details

## Mother board

### 17 to 65 Contacts

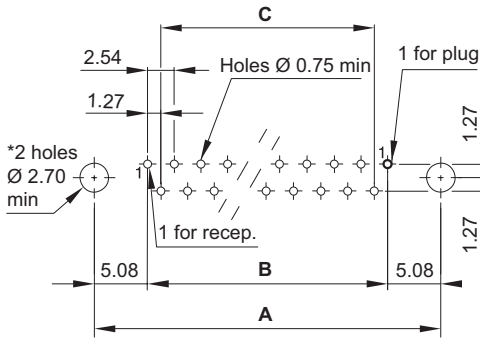

### 72 to 120 Contacts

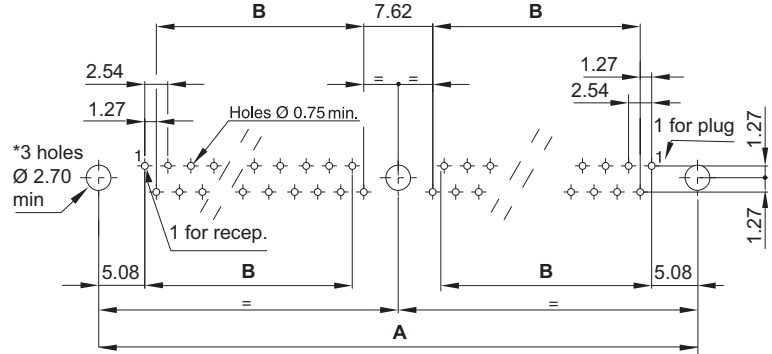

**Mother Board:** female or male, plug or receptacle, straight solder termination

**Guide styles:** 111 - 121 - 126 - 127 - 130 - 190 Locking styles: 202 - 215\* - 219 - 231

\* for ref: 215, holes  $\varnothing$  3.20 mm

## Daughter board

### 17 to 65 Contacts

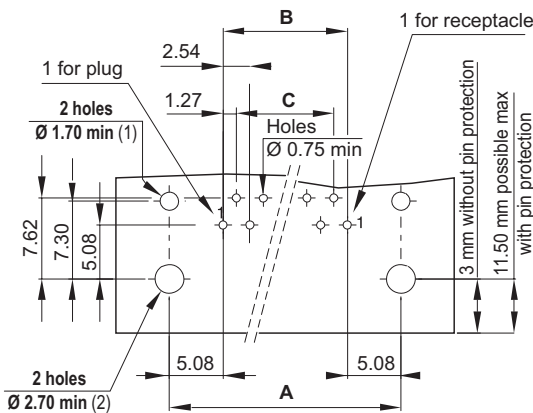

### 72 to 120 Contacts

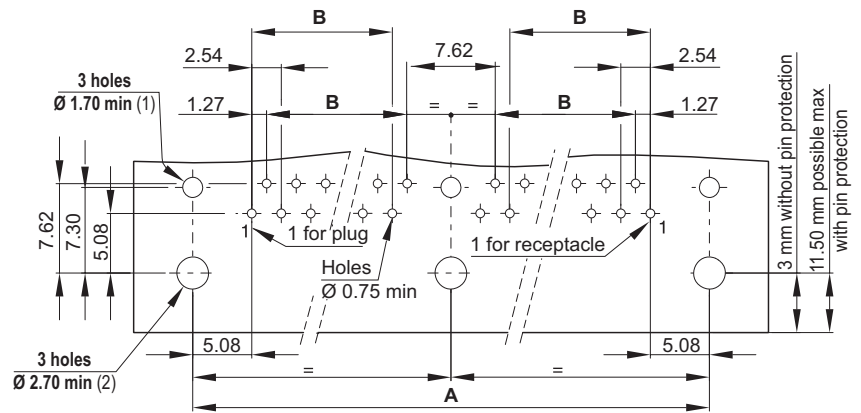

**Daughter Board:** female or male, plug or receptacle, 90° termination

(1) **Guide styles:** 124 - 131 - 132 - 133 - 145 Locking styles: 204 - 212

(2) **Guide styles:** 110 - 125 - 191 Locking styles: 203 - 208

No. of contacts	17	29	41	53	65	72	84	96	120
A	30.48	45.72	60.96	76.20	91.44	106.68	121.92	137.16	167.64
B	20.32	35.56	50.80	66.04	81.28	43.18	50.80	58.42	73.66
D	17.78	33.02	48.26	63.50	78.74	-	-	-	-

# Technical Characteristics

Contact diameter	HYPERTAC® type Ø 0.60 mm rear removable
Number of contact	53
Pitch	2.54 mm between rows - 1.27 mm between quicuncial contacts
Rows	2

## Materials & Platings

Contact	Brass or bronze
Molding	Glass fiber filled diallyl - Phtalate
Guides	Stainless steel or nickel plated brass
Pin body	0.25 µm gold / 1.27 µm Ni
Socket body	0.25 µm gold / 1.27 µm Ni on active area; 1.27 µm Ni on non active area
Socket wires	1 µm gold / 0.20 µm Ni

## Electrical

Current rating (at 25°C)	3 A max.
Dielectric withstanding voltage	1200 Vrms
Contact resistance	≤8 mΩ
Insulation resistance	>104 MΩ (500 Vcc)

## Mechanical

Mating & unmating cycle	5000
Guiding	By two outside guides (2 guiding styles) and one central guide (3 guiding styles)
Keying	By rotating of outside polarized guides (up to 36 keying)

## Environmental

Temperature range	-55° C to 125° C
Conformity	NF C-UTE C 93-424

# How To Order



<b>1</b> Thermoplastic material	X																																																									
<b>2</b> Molding polarity	<table border="1"> <thead> <tr> <th colspan="3">NF C-UTE C 93-424 MIL-C-55302 SPACE GRADE</th> <th colspan="3">NF C-UTE C 93-424 MIL-C-55302 SPACE GRADE</th> <th colspan="3">NF C-UTE C 93-424 MIL-C-55302 SPACE GRADE</th> </tr> </thead> <tbody> <tr> <td>12</td><td>14</td><td>54</td><td>Female plug</td> <td>1A</td><td>1C</td><td>5A</td><td>Tinned female plug**</td> <td>26</td><td>28</td><td>46</td><td>Tinned female receptacle*</td> </tr> <tr> <td>13</td><td>15</td><td>55</td><td>Male plug</td> <td>1B</td><td>1D</td><td>5B</td><td>Tinned male plug**</td> <td>27</td><td>29</td><td>47</td><td>Tinned male receptacle*</td> </tr> <tr> <td>16</td><td>18</td><td>56</td><td>Tinned female plug*</td> <td>22</td><td>24</td><td>44</td><td>Female receptacle</td> <td>2A</td><td>2C</td><td>-</td><td>Tinned female receptacle**</td> </tr> <tr> <td>17</td><td>19</td><td>57</td><td>Tinned male plug*</td> <td>23</td><td>25</td><td>45</td><td>Male receptacle</td> <td>2B</td><td>2D</td><td>-</td><td>Tinned male receptacle**</td> </tr> </tbody> </table>	NF C-UTE C 93-424 MIL-C-55302 SPACE GRADE			NF C-UTE C 93-424 MIL-C-55302 SPACE GRADE			NF C-UTE C 93-424 MIL-C-55302 SPACE GRADE			12	14	54	Female plug	1A	1C	5A	Tinned female plug**	26	28	46	Tinned female receptacle*	13	15	55	Male plug	1B	1D	5B	Tinned male plug**	27	29	47	Tinned male receptacle*	16	18	56	Tinned female plug*	22	24	44	Female receptacle	2A	2C	-	Tinned female receptacle**	17	19	57	Tinned male plug*	23	25	45	Male receptacle	2B	2D	-	Tinned male receptacle**
NF C-UTE C 93-424 MIL-C-55302 SPACE GRADE			NF C-UTE C 93-424 MIL-C-55302 SPACE GRADE			NF C-UTE C 93-424 MIL-C-55302 SPACE GRADE																																																				
12	14	54	Female plug	1A	1C	5A	Tinned female plug**	26	28	46	Tinned female receptacle*																																															
13	15	55	Male plug	1B	1D	5B	Tinned male plug**	27	29	47	Tinned male receptacle*																																															
16	18	56	Tinned female plug*	22	24	44	Female receptacle	2A	2C	-	Tinned female receptacle**																																															
17	19	57	Tinned male plug*	23	25	45	Male receptacle	2B	2D	-	Tinned male receptacle**																																															
<b>3</b> Termination styles	<table border="1"> <tbody> <tr> <td>10</td><td>Through board solder - 90° - length 3 mm</td> <td>13</td><td>Through board solder - 90° - length 2.3 mm, plug only</td> </tr> <tr> <td>11</td><td>Through board solder - 90° - length 4 mm</td> <td>14</td><td>Through board solder - 90° - length 8 mm, receptacle only</td> </tr> <tr> <td>12</td><td>Through board solder - 90° - length 5.1 mm, plug only</td> <td></td><td></td> </tr> </tbody> </table>	10	Through board solder - 90° - length 3 mm	13	Through board solder - 90° - length 2.3 mm, plug only	11	Through board solder - 90° - length 4 mm	14	Through board solder - 90° - length 8 mm, receptacle only	12	Through board solder - 90° - length 5.1 mm, plug only																																															
10	Through board solder - 90° - length 3 mm	13	Through board solder - 90° - length 2.3 mm, plug only																																																							
11	Through board solder - 90° - length 4 mm	14	Through board solder - 90° - length 8 mm, receptacle only																																																							
12	Through board solder - 90° - length 5.1 mm, plug only																																																									
<b>4</b> Mounting hardware	<p><b>Guide Style***</b></p> <table border="1"> <tbody> <tr> <td>110</td><td>Male polarized, transverse mount, standard plug</td> <td>131</td><td>Male unpolarized, transverse mount</td> </tr> <tr> <td>121</td><td>Female polarized, vertical mount</td> <td>145</td><td>Male polarized, transverse mount on receptacle only</td> </tr> <tr> <td>124</td><td>Female polarized, transverse mount</td> <td>191</td><td>Male power or mass contact, vertical mount</td> </tr> <tr> <td>125</td><td>Male unpolarized, transverse mount</td> <td></td><td></td> </tr> </tbody> </table> <p><b>Locking Styles***</b></p> <table border="1"> <thead> <tr> <th colspan="2">FEMALE RECEPTACLE</th> <th colspan="2">MALE PLUG</th> </tr> </thead> <tbody> <tr> <td>204</td><td>1/4 turn, transverse mount</td> <td>218</td><td>Jackscrew, transverse mount</td> </tr> <tr> <td></td><td></td> <td>203</td><td>1/4 turn, transverse mount</td> </tr> </tbody> </table>	110	Male polarized, transverse mount, standard plug	131	Male unpolarized, transverse mount	121	Female polarized, vertical mount	145	Male polarized, transverse mount on receptacle only	124	Female polarized, transverse mount	191	Male power or mass contact, vertical mount	125	Male unpolarized, transverse mount			FEMALE RECEPTACLE		MALE PLUG		204	1/4 turn, transverse mount	218	Jackscrew, transverse mount			203	1/4 turn, transverse mount																													
110	Male polarized, transverse mount, standard plug	131	Male unpolarized, transverse mount																																																							
121	Female polarized, vertical mount	145	Male polarized, transverse mount on receptacle only																																																							
124	Female polarized, transverse mount	191	Male power or mass contact, vertical mount																																																							
125	Male unpolarized, transverse mount																																																									
FEMALE RECEPTACLE		MALE PLUG																																																								
204	1/4 turn, transverse mount	218	Jackscrew, transverse mount																																																							
		203	1/4 turn, transverse mount																																																							

\* No RoHS compliant = 16 et 17

\*\* RoHS Compliant = 1A et 1B

# Connector Dimensions

## Plug

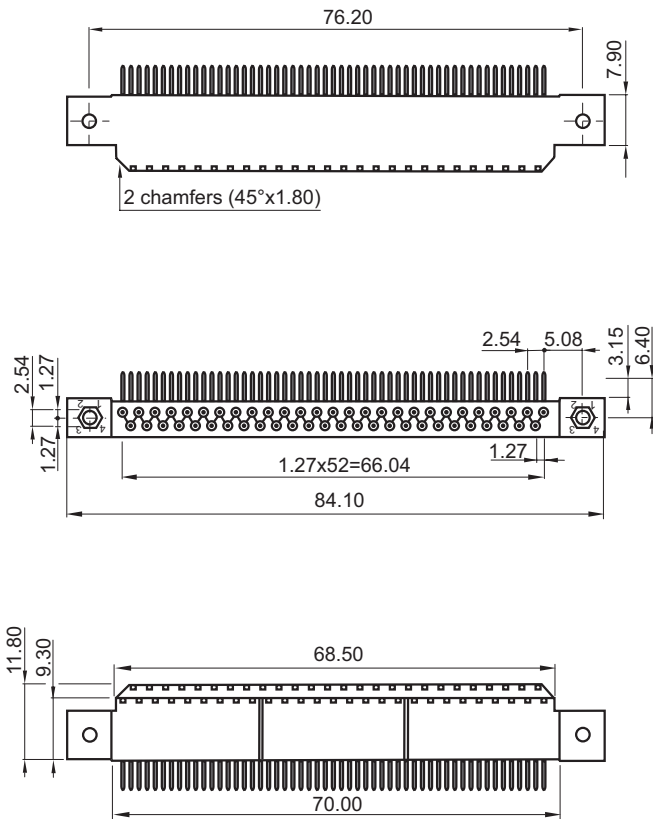

## Receptacle

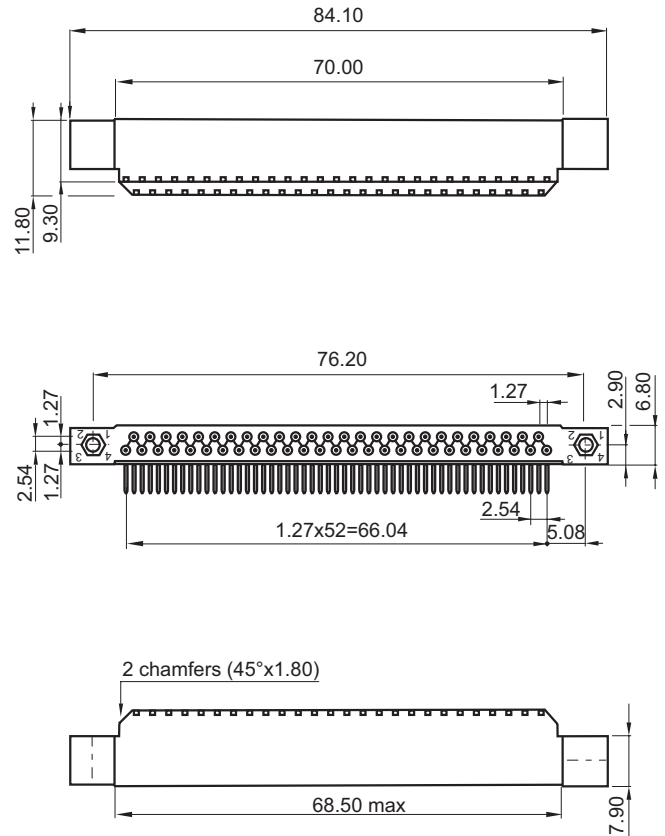

# Technical Characteristics

Contact diameter	HYPERTAC® type Ø 0.60 mm rear removable
Number of contact	Up to 160
Pitch	2.54 mm between rows - 1.27 mm between quicuncial contacts
Rows	3

## Materials & Platings

Contact	Brass or bronze	
Molding	Glass fiber filled diallyl - Phtalate	
Guides	Stainless steel or nickel plated brass	
	<b>Standard</b>	<b>ESA</b>
Pin body	0.25 µm gold / 1.27 µm Ni	1.27 µm gold / 1.27 µm Ni (min)
Socket body	0.25 µm gold / 1.27 µm Ni on active area 1.27 µm Ni on non active area	0.25 µm gold / 1.27 µm Ni (min)
Socket wires	1 µm gold / 0.20 µm Ni	1.27 µm gold / 0.20 µm Ni (min)

## Electrical

Current grade rating (at 25°C)	Standard grade: 3 A max - ESA grade: 5 A max
Dielectric withstanding voltage	1200 Vrms
Contact resistance	≤8 mΩ
Insulation resistance	>104 MΩ (500 Vcc)

## Mechanical

Mating & unmating cycle	5000
Guiding	By two outside guides (2 guiding styles) and one central guide (3 guiding styles)
Keying	By rotating of outside polarized guides (up to 36 keying)

## Environmental

Temperature range	-55°C to 125°C
Conformity	MIL C 55302, ESA/ESCC3401/016 - 3401/017, NF C-UTE C 93-424

# How To Order



1 Series																																																																			
2 Pitch or type	<b>N</b> 1.27 mm pitch, rear removable contacts																																																																		
3 Model	<b>C</b> 3 rows centered fixing <b>D</b> 3 rows uncentered fixing																																																																		
4 Number of contacts	<b>KNC</b> <b>062</b> <b>080</b> <b>098</b> <b>160</b> <b>KND</b> <b>026</b> <b>044</b> <b>062</b> <b>080</b> <b>098</b> <b>108</b> <b>126</b> <b>144</b>																																																																		
5 Molding polarity	<table border="1"> <tr> <td colspan="2"> <b>NF C-UTE C 93-424</b>  <b>MIL-C-55302</b>                      ESA/ESCC 3401/01601B                      SPACE GRADE                 </td> <td colspan="2"> <b>NF C-UTE C 93-424</b>  <b>MIL-C-55302</b>                      ESA/ESCC 3401/01601B                      SPACE GRADE                 </td> <td colspan="2"> <b>NF C-UTE C 93-424</b>  <b>MIL-C-55302</b>                      ESA/ESCC 3401/01601B                      SPACE GRADE                 </td> </tr> <tr> <td>12</td><td>14</td><td>54</td><td>54</td><td>Female plug</td> <td>1A</td><td>1C</td><td>-</td><td>5A</td><td>Tinned female plug**</td> <td>26</td><td>28</td><td>-</td><td>46</td><td>Tinned female receptacle*</td> </tr> <tr> <td>13</td><td>15</td><td>55</td><td>55</td><td>Male plug</td> <td>1B</td><td>1D</td><td>-</td><td>5B</td><td>Tinned male plug**</td> <td>27</td><td>29</td><td>-</td><td>47</td><td>Tinned male receptacle*</td> </tr> <tr> <td>16</td><td>18</td><td>-</td><td>56</td><td>Tinned female plug*</td> <td>22</td><td>24</td><td>44</td><td>44</td><td>Female receptacle</td> <td>2A</td><td>2C</td><td>-</td><td>-</td><td>Tinned female receptacle**</td> </tr> <tr> <td>17</td><td>19</td><td>-</td><td>57</td><td>Tinned male plug*</td> <td>23</td><td>25</td><td>45</td><td>45</td><td>Male receptacle</td> <td>2B</td><td>2D</td><td>-</td><td>-</td><td>Tinned male receptacle**</td> </tr> </table>	<b>NF C-UTE C 93-424</b> <b>MIL-C-55302</b> ESA/ESCC 3401/01601B SPACE GRADE		<b>NF C-UTE C 93-424</b> <b>MIL-C-55302</b> ESA/ESCC 3401/01601B SPACE GRADE		<b>NF C-UTE C 93-424</b> <b>MIL-C-55302</b> ESA/ESCC 3401/01601B SPACE GRADE		12	14	54	54	Female plug	1A	1C	-	5A	Tinned female plug**	26	28	-	46	Tinned female receptacle*	13	15	55	55	Male plug	1B	1D	-	5B	Tinned male plug**	27	29	-	47	Tinned male receptacle*	16	18	-	56	Tinned female plug*	22	24	44	44	Female receptacle	2A	2C	-	-	Tinned female receptacle**	17	19	-	57	Tinned male plug*	23	25	45	45	Male receptacle	2B	2D	-	-	Tinned male receptacle**
<b>NF C-UTE C 93-424</b> <b>MIL-C-55302</b> ESA/ESCC 3401/01601B SPACE GRADE		<b>NF C-UTE C 93-424</b> <b>MIL-C-55302</b> ESA/ESCC 3401/01601B SPACE GRADE		<b>NF C-UTE C 93-424</b> <b>MIL-C-55302</b> ESA/ESCC 3401/01601B SPACE GRADE																																																															
12	14	54	54	Female plug	1A	1C	-	5A	Tinned female plug**	26	28	-	46	Tinned female receptacle*																																																					
13	15	55	55	Male plug	1B	1D	-	5B	Tinned male plug**	27	29	-	47	Tinned male receptacle*																																																					
16	18	-	56	Tinned female plug*	22	24	44	44	Female receptacle	2A	2C	-	-	Tinned female receptacle**																																																					
17	19	-	57	Tinned male plug*	23	25	45	45	Male receptacle	2B	2D	-	-	Tinned male receptacle**																																																					
6 Termination styles	<table border="1"> <tr> <td><b>10</b> Through board solder - 90° - length 3 mm</td> <td><b>21</b> Double crimp</td> <td><b>51</b> Wire wrap (3 wrapping levels)</td> </tr> <tr> <td><b>11</b> Through board solder - 90° - length 4 mm</td> <td><b>30</b> Through board solder - straight</td> <td><b>91</b> Female - male</td> </tr> <tr> <td><b>20</b> Crimp</td> <td><b>40</b> Solder bucket</td> <td></td> </tr> </table>	<b>10</b> Through board solder - 90° - length 3 mm	<b>21</b> Double crimp	<b>51</b> Wire wrap (3 wrapping levels)	<b>11</b> Through board solder - 90° - length 4 mm	<b>30</b> Through board solder - straight	<b>91</b> Female - male	<b>20</b> Crimp	<b>40</b> Solder bucket																																																										
<b>10</b> Through board solder - 90° - length 3 mm	<b>21</b> Double crimp	<b>51</b> Wire wrap (3 wrapping levels)																																																																	
<b>11</b> Through board solder - 90° - length 4 mm	<b>30</b> Through board solder - straight	<b>91</b> Female - male																																																																	
<b>20</b> Crimp	<b>40</b> Solder bucket																																																																		
7 Mounting hardware	<p><b>Guide Style (consult us for special guides)</b></p> <table border="1"> <tr> <td><b>110</b> Male polarized, transverse mount, standard plug</td> <td><b>145</b> Male polarized, transverse mount on receptacle only</td> <td><b>131</b> Male unpolarized, transverse mount</td> </tr> <tr> <td><b>111</b> Male polarized, vertical mount</td> <td><b>190</b> Female power or mass contact, vertical mount</td> <td><b>132</b> Female unpolarized, transverse mount</td> </tr> <tr> <td><b>113</b> Male polarized, float mount</td> <td><b>125</b> Male unpolarized, transverse mount</td> <td><b>133</b> Female all polarized, transverse mount</td> </tr> <tr> <td><b>121</b> Female polarized, vertical mount</td> <td><b>126</b> Female unpolarized, vertical mount</td> <td><b>191</b> Male power or mass contact, vertical mount</td> </tr> <tr> <td><b>123</b> Female polarized, float mount</td> <td><b>127</b> Male unpolarized, vertical mount</td> <td></td> </tr> <tr> <td><b>124</b> Female polarized, transverse mount</td> <td><b>130</b> Female unpolarized, vertical mount</td> <td></td> </tr> </table> <p><b>Locking Styles</b></p> <table border="1"> <thead> <tr> <th colspan="2">MALE PLUG</th> <th colspan="2">FEMALE RECEPTACLE</th> </tr> </thead> <tbody> <tr> <td><b>201</b> 1/4 turn, free connector</td> <td><b>202</b> 1/4 turn, vertical mount</td> <td><b>212</b> Jackscrew, transverse mount</td> <td></td> </tr> <tr> <td><b>203</b> 1/4 turn, transverse mount</td> <td><b>204</b> 1/4 turn, transverse mount</td> <td><b>215</b> Jackscrew, vertical mount</td> <td></td> </tr> <tr> <td><b>207</b> Jackscrew, free connector</td> <td><b>208</b> Jackscrew, transverse mount</td> <td><b>219</b> Jackscrew, vertical mount</td> <td></td> </tr> <tr> <td><b>211</b> Jackscrew, free connector</td> <td><b>210</b> Jackscrew, free connector</td> <td><b>232</b> Jackscrew, with operation button</td> <td></td> </tr> <tr> <td><b>290</b> Jackscrew, vertical mount</td> <td></td> <td></td> <td></td> </tr> </tbody> </table>	<b>110</b> Male polarized, transverse mount, standard plug	<b>145</b> Male polarized, transverse mount on receptacle only	<b>131</b> Male unpolarized, transverse mount	<b>111</b> Male polarized, vertical mount	<b>190</b> Female power or mass contact, vertical mount	<b>132</b> Female unpolarized, transverse mount	<b>113</b> Male polarized, float mount	<b>125</b> Male unpolarized, transverse mount	<b>133</b> Female all polarized, transverse mount	<b>121</b> Female polarized, vertical mount	<b>126</b> Female unpolarized, vertical mount	<b>191</b> Male power or mass contact, vertical mount	<b>123</b> Female polarized, float mount	<b>127</b> Male unpolarized, vertical mount		<b>124</b> Female polarized, transverse mount	<b>130</b> Female unpolarized, vertical mount		MALE PLUG		FEMALE RECEPTACLE		<b>201</b> 1/4 turn, free connector	<b>202</b> 1/4 turn, vertical mount	<b>212</b> Jackscrew, transverse mount		<b>203</b> 1/4 turn, transverse mount	<b>204</b> 1/4 turn, transverse mount	<b>215</b> Jackscrew, vertical mount		<b>207</b> Jackscrew, free connector	<b>208</b> Jackscrew, transverse mount	<b>219</b> Jackscrew, vertical mount		<b>211</b> Jackscrew, free connector	<b>210</b> Jackscrew, free connector	<b>232</b> Jackscrew, with operation button		<b>290</b> Jackscrew, vertical mount																											
<b>110</b> Male polarized, transverse mount, standard plug	<b>145</b> Male polarized, transverse mount on receptacle only	<b>131</b> Male unpolarized, transverse mount																																																																	
<b>111</b> Male polarized, vertical mount	<b>190</b> Female power or mass contact, vertical mount	<b>132</b> Female unpolarized, transverse mount																																																																	
<b>113</b> Male polarized, float mount	<b>125</b> Male unpolarized, transverse mount	<b>133</b> Female all polarized, transverse mount																																																																	
<b>121</b> Female polarized, vertical mount	<b>126</b> Female unpolarized, vertical mount	<b>191</b> Male power or mass contact, vertical mount																																																																	
<b>123</b> Female polarized, float mount	<b>127</b> Male unpolarized, vertical mount																																																																		
<b>124</b> Female polarized, transverse mount	<b>130</b> Female unpolarized, vertical mount																																																																		
MALE PLUG		FEMALE RECEPTACLE																																																																	
<b>201</b> 1/4 turn, free connector	<b>202</b> 1/4 turn, vertical mount	<b>212</b> Jackscrew, transverse mount																																																																	
<b>203</b> 1/4 turn, transverse mount	<b>204</b> 1/4 turn, transverse mount	<b>215</b> Jackscrew, vertical mount																																																																	
<b>207</b> Jackscrew, free connector	<b>208</b> Jackscrew, transverse mount	<b>219</b> Jackscrew, vertical mount																																																																	
<b>211</b> Jackscrew, free connector	<b>210</b> Jackscrew, free connector	<b>232</b> Jackscrew, with operation button																																																																	
<b>290</b> Jackscrew, vertical mount																																																																			

\* For 90° & straight terminations (splicing on PCB)  
 \*\* RoHS compliant for 90° & straight terminations (splicing on PCB)



# Hypertac & ESA Correspondence Table

**HYPERTAC** **KNC**

34 01 016 01 B

1

2

3

4

5

6

<p><b>1</b> ESCC component number</p>																																																																																																				
<p><b>2</b> Mounting</p>	<table border="1"> <thead> <tr> <th colspan="4">HYPERTAC</th> <th colspan="4">ESA</th> </tr> </thead> <tbody> <tr> <td>Plug KNB 017</td><td>01</td> <td>Plug KNB 096</td><td>08</td> <td>Receptacle KNB 053</td><td>16</td> <td>Plug KNB 072</td><td>56</td> <td>Plug KNC 098</td><td>62</td> </tr> <tr> <td>Plug KNB 029</td><td>02</td> <td>Plug KNB 120</td><td>10</td> <td>Receptacle KNB 065</td><td>17</td> <td>Receptacle KNB 072</td><td>57</td> <td>Receptacle KNC 098</td><td>63</td> </tr> <tr> <td>Plug KNB 041</td><td>03</td> <td>Plug KNC 160</td><td>12</td> <td>Receptacle KNB 084</td><td>19</td> <td>Plug KNC 062</td><td>58</td> <td></td><td></td> </tr> <tr> <td>Plug KNB 053</td><td>04</td> <td>Receptacle KNB 017</td><td>13</td> <td>Receptacle KNB 096</td><td>20</td> <td>Receptacle KNC 062</td><td>59</td> <td></td><td></td> </tr> <tr> <td>Plug KNB 065</td><td>05</td> <td>Receptacle KNB 029</td><td>14</td> <td>Receptacle KNB 120</td><td>22</td> <td>Plug KNC 080</td><td>60</td> <td></td><td></td> </tr> <tr> <td>Plug KNB 084</td><td>07</td> <td>Receptacle KNB 041</td><td>15</td> <td>Receptacle KNC 160</td><td>24</td> <td>Receptacle KNC 080</td><td>61</td> <td></td><td></td> </tr> </tbody> </table> <table border="1"> <tr> <td colspan="4">REMINDER SPATIAL P.P.P. (Party Polarity Protection)</td> <td colspan="4">EXAMPLE</td> </tr> <tr> <td>Female receptacle</td><td>44</td> <td>Plug female</td><td>54</td> <td colspan="4">KNC 062 44 30 113</td> </tr> <tr> <td>Male receptacle</td><td>45</td> <td>Plug male</td><td>55</td> <td colspan="4">P.P.P. </td> </tr> </table>								HYPERTAC				ESA				Plug KNB 017	01	Plug KNB 096	08	Receptacle KNB 053	16	Plug KNB 072	56	Plug KNC 098	62	Plug KNB 029	02	Plug KNB 120	10	Receptacle KNB 065	17	Receptacle KNB 072	57	Receptacle KNC 098	63	Plug KNB 041	03	Plug KNC 160	12	Receptacle KNB 084	19	Plug KNC 062	58			Plug KNB 053	04	Receptacle KNB 017	13	Receptacle KNB 096	20	Receptacle KNC 062	59			Plug KNB 065	05	Receptacle KNB 029	14	Receptacle KNB 120	22	Plug KNC 080	60			Plug KNB 084	07	Receptacle KNB 041	15	Receptacle KNC 160	24	Receptacle KNC 080	61			REMINDER SPATIAL P.P.P. (Party Polarity Protection)				EXAMPLE				Female receptacle	44	Plug female	54	KNC 062 44 30 113				Male receptacle	45	Plug male	55	P.P.P.			
HYPERTAC				ESA																																																																																																
Plug KNB 017	01	Plug KNB 096	08	Receptacle KNB 053	16	Plug KNB 072	56	Plug KNC 098	62																																																																																											
Plug KNB 029	02	Plug KNB 120	10	Receptacle KNB 065	17	Receptacle KNB 072	57	Receptacle KNC 098	63																																																																																											
Plug KNB 041	03	Plug KNC 160	12	Receptacle KNB 084	19	Plug KNC 062	58																																																																																													
Plug KNB 053	04	Receptacle KNB 017	13	Receptacle KNB 096	20	Receptacle KNC 062	59																																																																																													
Plug KNB 065	05	Receptacle KNB 029	14	Receptacle KNB 120	22	Plug KNC 080	60																																																																																													
Plug KNB 084	07	Receptacle KNB 041	15	Receptacle KNC 160	24	Receptacle KNC 080	61																																																																																													
REMINDER SPATIAL P.P.P. (Party Polarity Protection)				EXAMPLE																																																																																																
Female receptacle	44	Plug female	54	KNC 062 44 30 113																																																																																																
Male receptacle	45	Plug male	55	P.P.P.																																																																																																
<p><b>3</b> Termination style</p>	<table border="1"> <thead> <tr> <th colspan="4">HYPERTAC</th> <th colspan="4">ESA</th> </tr> </thead> <tbody> <tr> <td>Bent male 10</td><td>MC</td> <td>Solder bucket male 40</td><td>MS</td> <td>Crimp female 20</td><td>FR</td> <td colspan="2">Female-male 91</td><td>FM</td> </tr> <tr> <td>Bent long male 11</td><td>ML</td> <td>Mini-wrapping male 51</td><td>MY</td> <td>Straight female 30</td><td>FD</td> <td colspan="3"></td> </tr> <tr> <td>Crimp male 20</td><td>MR</td> <td>Bent female 10</td><td>FC</td> <td>Solder bucket female 40</td><td>FS</td> <td colspan="3"></td> </tr> <tr> <td>Straight male 30</td><td>MD</td> <td>Bent long female 11</td><td>FL</td> <td>Mini-wrapping female 51</td><td>FY</td> <td colspan="3"></td> </tr> </tbody> </table>								HYPERTAC				ESA				Bent male 10	MC	Solder bucket male 40	MS	Crimp female 20	FR	Female-male 91		FM	Bent long male 11	ML	Mini-wrapping male 51	MY	Straight female 30	FD				Crimp male 20	MR	Bent female 10	FC	Solder bucket female 40	FS				Straight male 30	MD	Bent long female 11	FL	Mini-wrapping female 51	FY																																																			
HYPERTAC				ESA																																																																																																
Bent male 10	MC	Solder bucket male 40	MS	Crimp female 20	FR	Female-male 91		FM																																																																																												
Bent long male 11	ML	Mini-wrapping male 51	MY	Straight female 30	FD																																																																																															
Crimp male 20	MR	Bent female 10	FC	Solder bucket female 40	FS																																																																																															
Straight male 30	MD	Bent long female 11	FL	Mini-wrapping female 51	FY																																																																																															
<p><b>4</b> Locking type On left side</p>	<table border="1"> <thead> <tr> <th colspan="4">HYPERTAC</th> <th colspan="4">ESA</th> </tr> </thead> <tbody> <tr> <td>Guideless connector</td><td>00</td> <td>KNB 145</td><td>40</td> <td>KNC 10 209</td><td>49</td> <td>KNB 11 125</td><td>71</td> <td>KNB 11 208</td><td>79</td> </tr> <tr> <td>KNB 131</td><td>31</td> <td>KNB 124</td><td>41</td> <td>KN 210</td><td>50</td> <td>KNB 11 110</td><td>72</td> <td>KN 219</td><td>80</td> </tr> <tr> <td>KNB 132</td><td>32</td> <td>KNC 10 230</td><td>43</td> <td>KN 211</td><td>51</td> <td>KNB 10 230</td><td>73</td> <td>KN 290*</td><td>81</td> </tr> <tr> <td>KNB 10 110</td><td>33</td> <td>KN 232</td><td>45</td> <td>KNB 212</td><td>52</td> <td>KNC 124</td><td>74</td> <td></td><td></td> </tr> <tr> <td>KNC 10 110</td><td>34</td> <td>KN 231</td><td>46</td> <td>KN 215</td><td>53</td> <td>KNC 132</td><td>75</td> <td></td><td></td> </tr> <tr> <td>KN 111</td><td>35</td> <td>KN 207</td><td>47</td> <td>KN 123</td><td>54</td> <td>KNC 11 110</td><td>76</td> <td></td><td></td> </tr> <tr> <td>KN 121</td><td>36</td> <td>KNB 10 208</td><td>48</td> <td>KN 113</td><td>55</td> <td>KNC 11 125</td><td>77</td> <td></td><td></td> </tr> </tbody> </table>								HYPERTAC				ESA				Guideless connector	00	KNB 145	40	KNC 10 209	49	KNB 11 125	71	KNB 11 208	79	KNB 131	31	KNB 124	41	KN 210	50	KNB 11 110	72	KN 219	80	KNB 132	32	KNC 10 230	43	KN 211	51	KNB 10 230	73	KN 290*	81	KNB 10 110	33	KN 232	45	KNB 212	52	KNC 124	74			KNC 10 110	34	KN 231	46	KN 215	53	KNC 132	75			KN 111	35	KN 207	47	KN 123	54	KNC 11 110	76			KN 121	36	KNB 10 208	48	KN 113	55	KNC 11 125	77																
HYPERTAC				ESA																																																																																																
Guideless connector	00	KNB 145	40	KNC 10 209	49	KNB 11 125	71	KNB 11 208	79																																																																																											
KNB 131	31	KNB 124	41	KN 210	50	KNB 11 110	72	KN 219	80																																																																																											
KNB 132	32	KNC 10 230	43	KN 211	51	KNB 10 230	73	KN 290*	81																																																																																											
KNB 10 110	33	KN 232	45	KNB 212	52	KNC 124	74																																																																																													
KNC 10 110	34	KN 231	46	KN 215	53	KNC 132	75																																																																																													
KN 111	35	KN 207	47	KN 123	54	KNC 11 110	76																																																																																													
KN 121	36	KNB 10 208	48	KN 113	55	KNC 11 125	77																																																																																													
<p><b>5</b> Locking type In center</p>	<p>00 For 2 guide connectors</p> <p>-- For 3 guide connectors (see table 4, Locking type - On left side)</p> <table border="1"> <thead> <tr> <th colspan="4">HYPERTAC</th> <th colspan="4">ESA</th> </tr> </thead> <tbody> <tr> <td>KNB 10 125</td><td>26</td> <td>KNC 10 125</td><td>27</td> <td>KN 127</td><td>28</td> <td>KN 126</td><td>29</td> <td colspan="2"></td> </tr> </tbody> </table>								HYPERTAC				ESA				KNB 10 125	26	KNC 10 125	27	KN 127	28	KN 126	29																																																																												
HYPERTAC				ESA																																																																																																
KNB 10 125	26	KNC 10 125	27	KN 127	28	KN 126	29																																																																																													
<p><b>6</b> Locking type On right side</p>	<p>(see table 4, Locking type - On left side)</p>																																																																																																			

Please consult us

# Contact Terminations

## Plug

## Receptacle

Male

Female

Female

Male

### 90° Through board solder

Ref: **10** (X=3)   Ref : **MC & FC** - Ref: **11** (X=4)   Ref : **ML & FL**

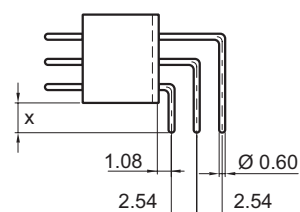
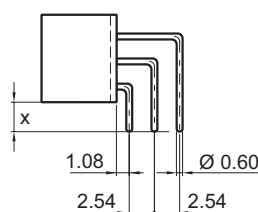
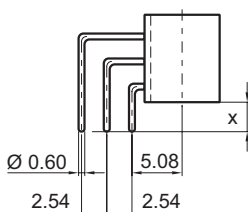
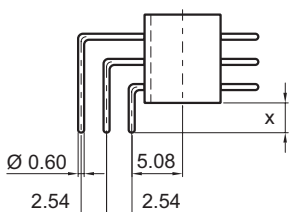

### Crimp (AWG 28-22)

Ref: **20**   Ref : **MR & FR**

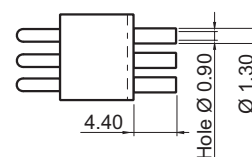
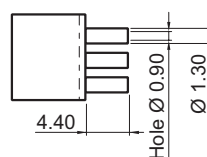
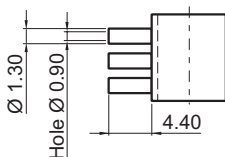
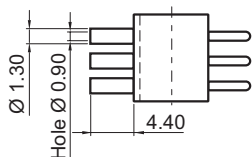

### Crimp (AWG 28-22)

Ref: **21**

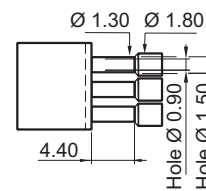
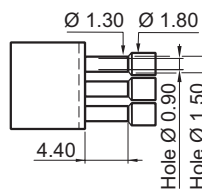
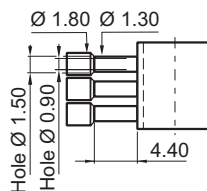
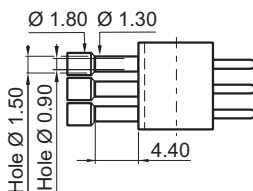

### Straight through board solder

Ref: **30**   Ref : **MD & FD**

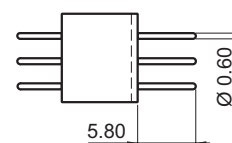
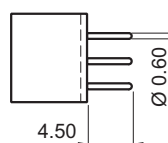
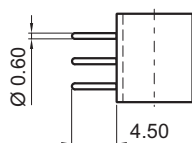
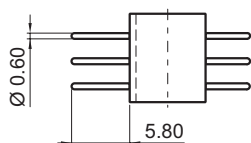

# Contact Terminations

## Plug

## Receptacle

Male

Female

Female

Male

### Solder bucket (AWG 22 max)

Ref: **40** Ref: **MS & FS**

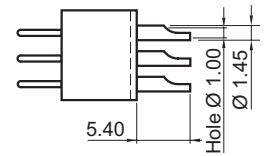
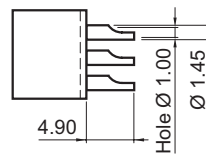
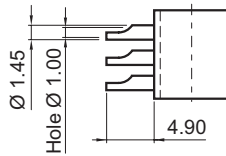
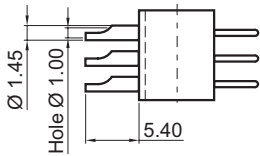

### Wire wrap (3 wrapping levels)

Ref: **51** Ref: **MY & FY**

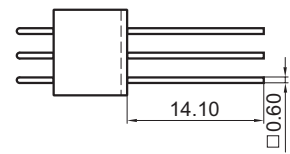
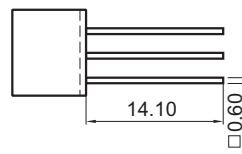
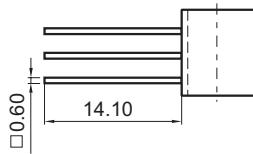
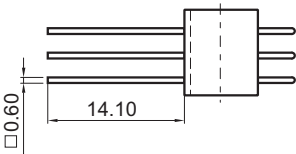

### Saver (male-male)

Ref: **90**

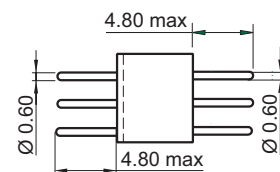
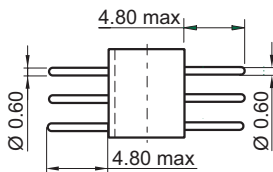

### Saver (female-male)

Ref: **91** Ref: **FM**

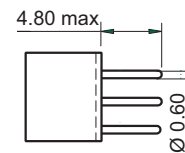
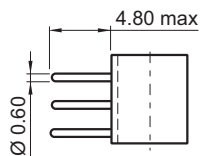

# Dimensions

## Plug

## Receptacle

26 to 98 contacts

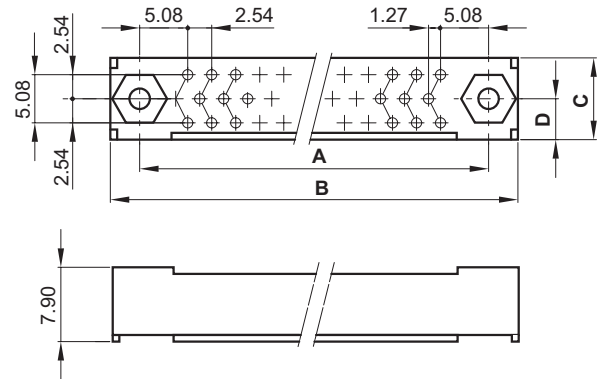
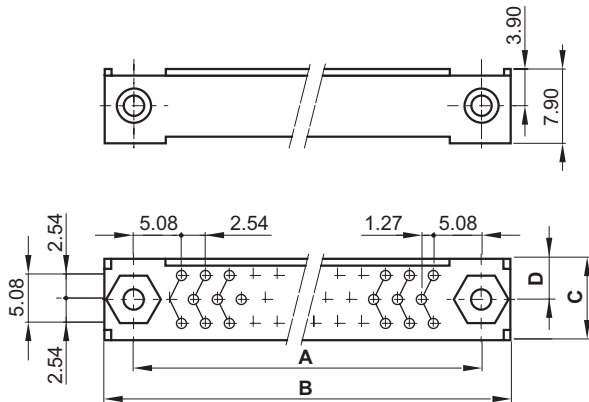

108 to 160 contacts

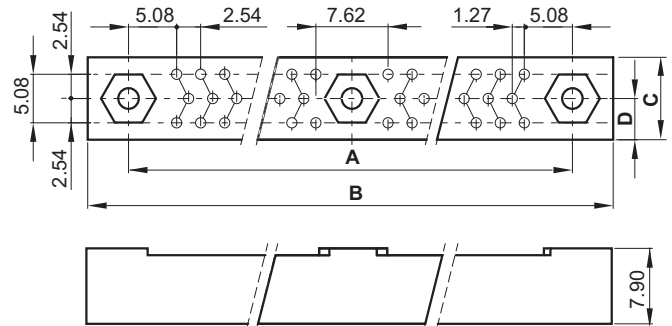
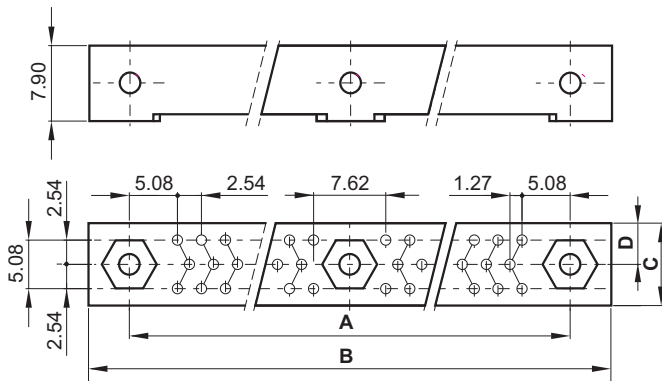

		No. of contacts	26	44	62	80	98	108	126	144	160
KNC	Plug & Receptacle	A	-	-	60.96	76.20	91.44	-	-	-	149.86
		B max	-	-	69.00	84.20	99.50	-	-	-	158.00
	Plug	C max	-	-	9.45	9.45	9.45	-	-	-	9.30
		D	-	-	4.42	4.42	4.42	-	-	-	4.70
	Receptacle	C max	-	-	9.30	9.30	9.30	-	-	-	9.30
		D	-	-	4.17	4.17	4.17	-	-	-	4.70
KND	Plug & Receptacle	A	30.48	45.72	60.96	76.20	91.44	106.68	121.92	137.16	-
		B max	38.50	53.70	69.00	84.20	99.50	114.70	129.90	145.20	-
	Plug	C min	8.95	8.95	8.95	8.95	8.95	8.95	8.95	8.95	-
		C max	9.55	9.55	9.55	9.55	9.55	9.55	9.55	9.55	-
		D	3.15	3.15	3.15	3.15	3.15	3.15	3.15	3.15	-
	Receptacle	C max	9.35	9.35	9.35	9.35	9.35	9.35	9.35	9.35	-
		D	3.10	3.10	3.10	3.10	3.10	3.10	3.10	3.10	-

# Guide Device and Polarity Termination Compatibility Chart

**Legend**

- Compatible
- Compatible special saver connector

**FP** = Female Plug

**FR** = Female Receptacle

**MR** = Male Receptacle

	MR 23	FR 22	FP 12	MP 13	MR 23	FR 22	FP 12	MP 13	MR 23	FR 22	FP 12	MP 13	MR 23	FR 22	FP 12	MP 13	MR 23	FR 22	FP 12	MP 13	MR 23	FR 22	FP 12	MP 13	Polarity		Molding	
																										Receptacle		
																										Plug		
																										90°	10	11
																										Straight	30	31
																										Solder bucket		40
																										Crimp	20	21
																										Wire wrap		51

Polarity	Receptacle	Plug	90°	Straight	Solder bucket	Crimp	Wire wrap - PPC	Guiding devices								Male guides		Female guides											
								190	133	132	130	126	124	123	121	191	145		131	127	125	113	111	110					
FP 12																													
MP 13																													
MR 23																													
FR 22																													
MR 23																													
FR 22																													
FP 12																													
MP 13																													
MR 23																													
FR 22																													
FP 12																													
MP 13																													
MR 23																													
FR 22																													
FP 12																													
MP 13																													

# Guide Styles

## Plug & Receptacle

Male

Polarized vertical mount

Ref: **111** Ref : **35**

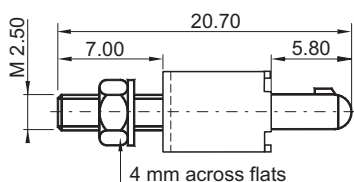

Female

Polarized vertical float mount

Ref: **123** Ref : **54**

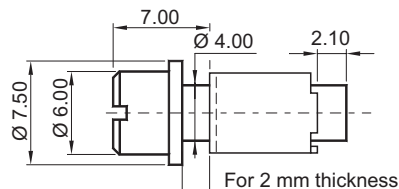

Polarized vertical float mount

Ref: **113** Ref : **55**

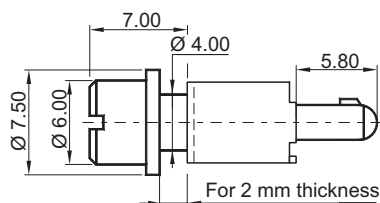

Polarized transverse mount

Ref: **124** Ref : **74**

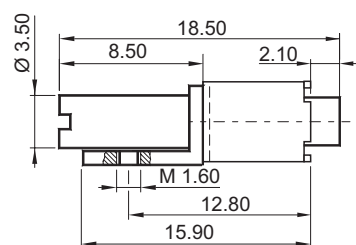

Unpolarized vertical mount

Ref: **127** Ref : **28**

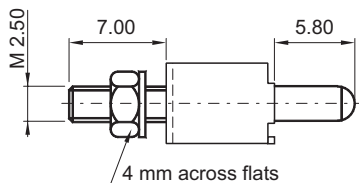

Unpolarized vertical mount

Ref: **126** Ref : **29**

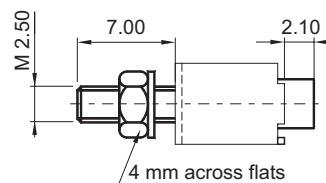

Unpolarized transverse mount

Ref: **131**

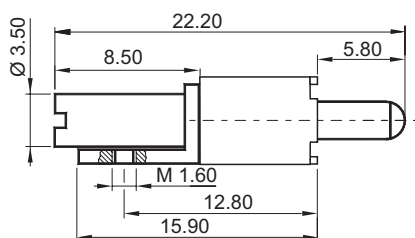

All polarized vertical mount

Ref: **130**

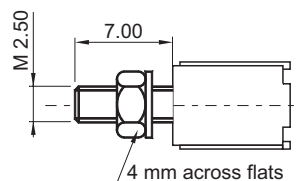

# Guide Styles

## Plug & Receptacle

Male

**Polarized transverse mount**

Ref: **145**

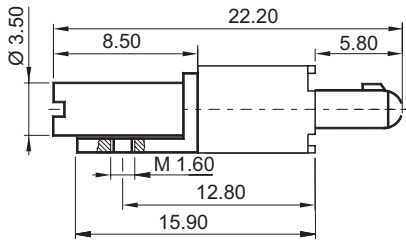

Female

**Unpolarized transverse mount**

Ref: **132** Ref: **75**

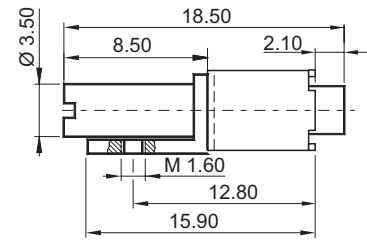

**Polarized vertical mount**

Ref: **121** Ref: **36**

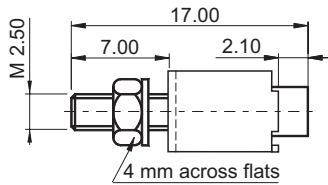

**All polarized transverse mount**

Ref: **133**

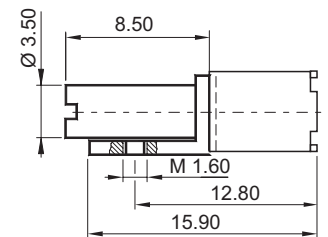

# Guide Styles

## Plug & Receptacle

### Male

#### Power or mass vertical mount

Ref: **191** PCB thickness **1.60**

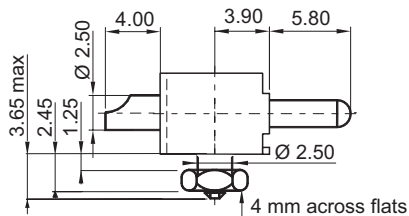

### Female

#### Power or mass vertical mount

Ref: **190**

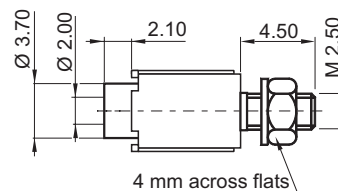

## Male plug only

#### Polarized transverse mount

Ref: **10 110** Ref : **34** PCB thickness **1.60**

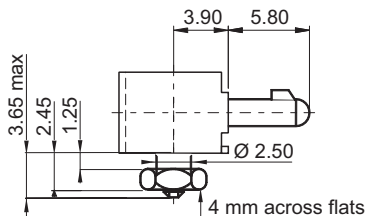

#### Unpolarized transverse mount

Ref: **10 125** Ref : **27** PCB thickness **1.60**

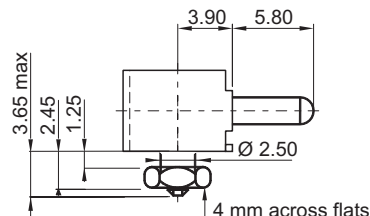



# Locking Devices Compatibility Chart

		R	P	R	P	R	P	R	P	R	P	R	P	R	P
Compatible															
												Receptacle	Molding		
												Plug			
P	R														
P	R														
P	R														
P	R														
P	R														
P	R														
P	R														
													290		
													231		
													211		
													207		
													205		
													203		
													201		
												Male locking devices			
												Female locking devices			
Receptacle															
Plug															
Molding															
		232	219	215	212	210	208	204	202						

# Male Locking Styles

## Plug & Receptacle

### Jack 1/4 turn lock, free connector

Ref: **201**

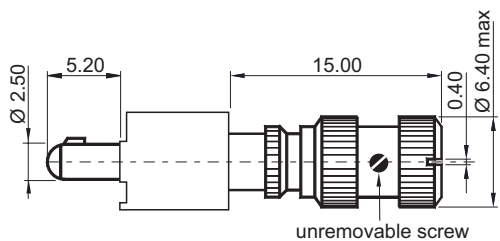

### Jackscrew, free connector

Ref: **211** Ref : **51**

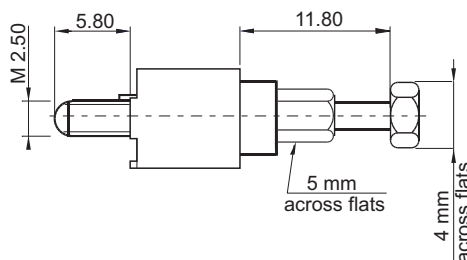

### Jack 1/4 turn lock, transverse mount

Ref: **206**

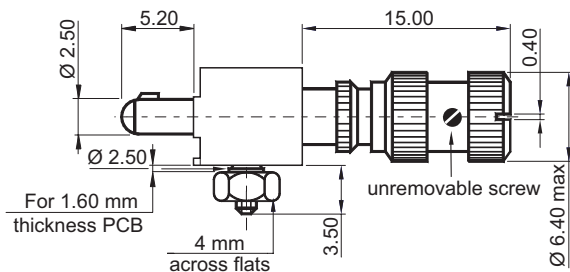

### Jackscrew, vertical mount

Ref: **231** Ref : **46**

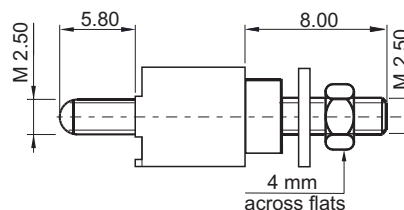

### Jackscrew, free connector

Ref: **207** Ref : **47**

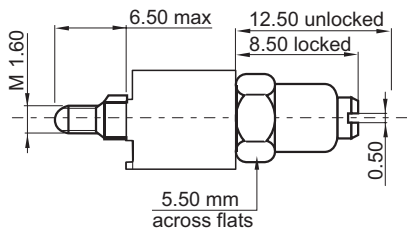

### Jackscrew, vertical mount

Ref: **290** Ref : **81**

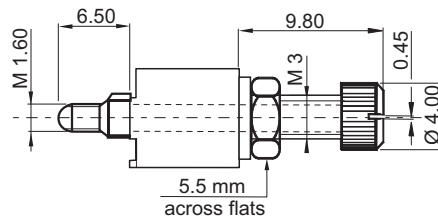

# Female Locking Styles

## Plug & Receptacle

### Jack 1/4 turn lock, vertical mount

Ref: **202**

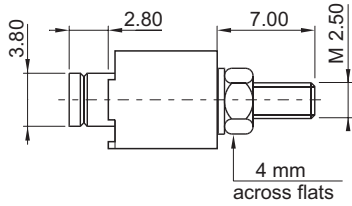

### Jackscrew, transverse mount

Ref: **212**

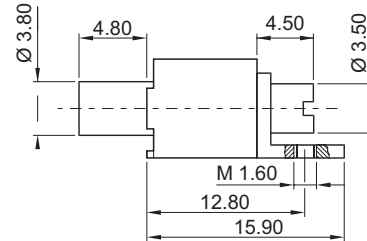

### Jackscrew, transverse mount

Ref: **10 209** Ref: **49** PCB thickness 1.60

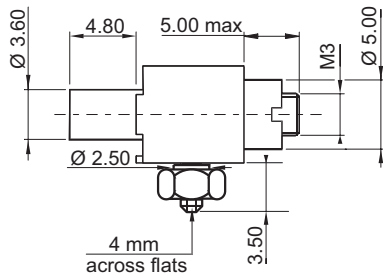

### Jackscrew, vertical mount

Ref: **215** Ref: **53**

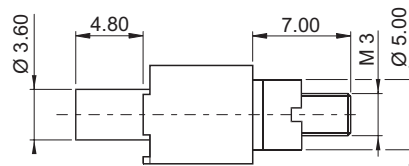

### Jackscrew, free connector

Ref: **210** Ref: **50**

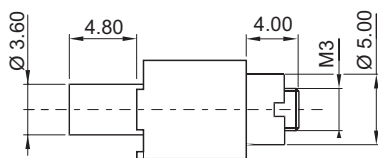

### Jackscrew, vertical mount

Ref: **219** Ref: **80**

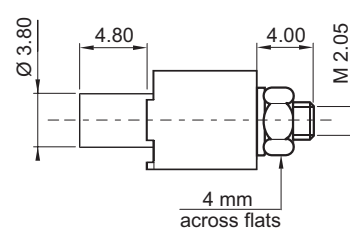

### Rotating jackscrew

Ref: **232**

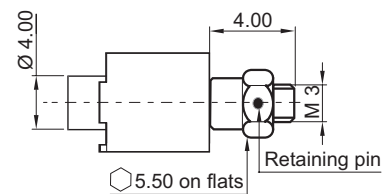

# Receptacle Mating Side Layout View

26 to 98 contacts

108 to 160 contacts

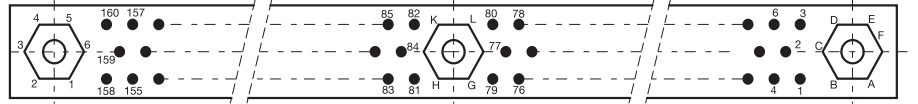
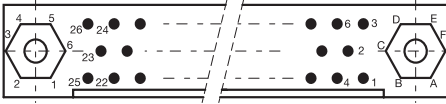

# Panel Preparation Details

26 to 98 contacts

108 to 160 contacts

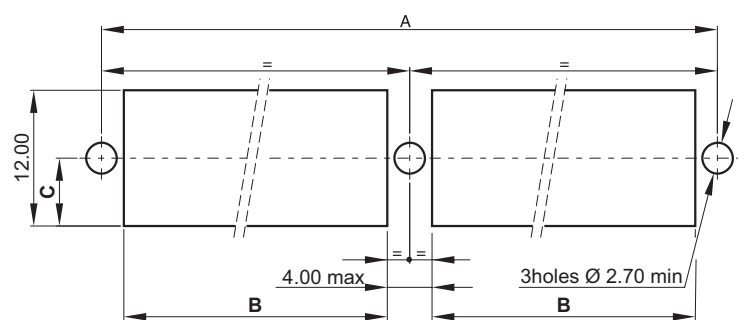
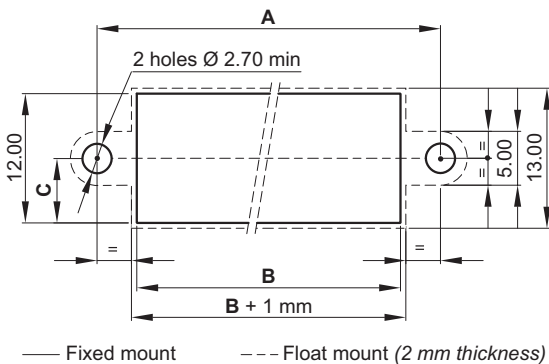

**Panel:** female or male, plug or receptacle

**Terminations:** 40 - 51

**Guide styles:** 111 - 121 (Fixed Mount)

**Guide styles:** 113 - 123 - 202 (Float Mount)

No. of contacts	26	44	62	80	98	108	126	144	160
A	30.48	45.72	60.96	76.20	91.44	106.68	121.92	137.16	149.86
B min	25.90	41.10	56.40	71.60	86.90	48.50	56.00	63.60	69.95
C (KNC)	-	-	6.00	6.00	6.00	-	-	-	6.00
C (KND)	4.73	4.73	4.73	4.73	4.73	4.73	4.73	4.73	-

# Board Preparation Details

## Mother board

26 to 98 Contacts

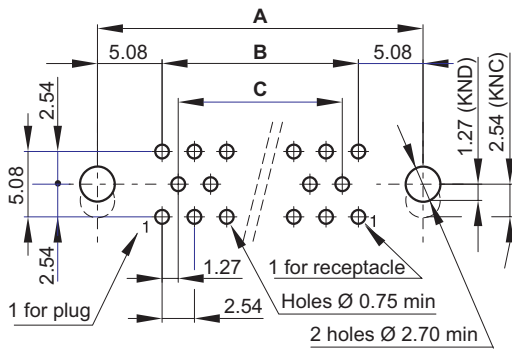

108 to 160 Contacts

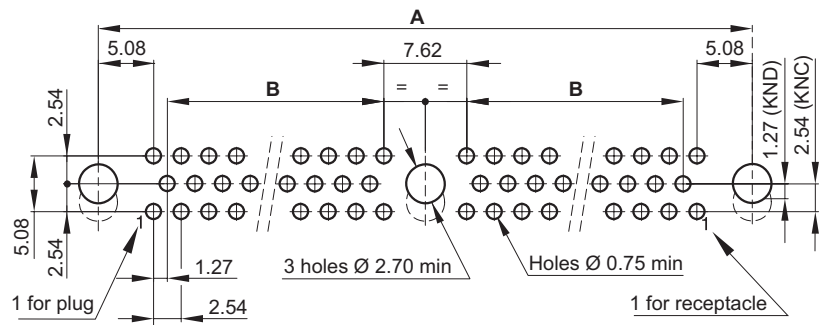

**Mother Board:** female or male, plug or receptacle, straight solder termination  
**Guide styles:** 111 - 121- 202

## Daughter board

26 to 98 Contacts

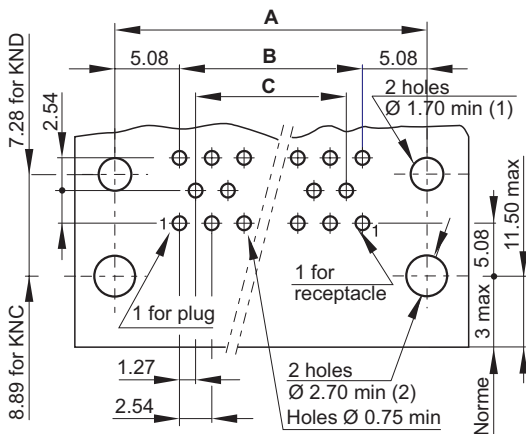

108 to 160 Contacts

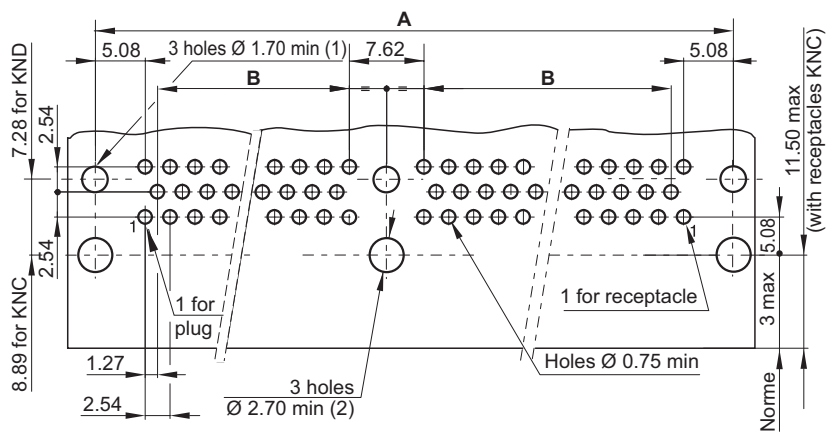

**Daughter Board:** female or male, plug or receptacle, 90° termination  
 (1) **Guide styles:** 124 (2) **Guide styles:** 110 - 206

No. of contacts	26	44	62	80	98	108	126	144	160
A	30.48	45.72	60.96	76.20	91.44	106.68	121.92	137.16	149.86
B	20.32	35.56	50.80	66.04	81.28	43.18	50.80	58.42	64.77
C	17.78	33.02	48.26	63.50	78.74	-	-	-	-

# Contacts

## Male

Crimp terminations AWG 22-28 (0.079 - 0.34 mm<sup>2</sup>)

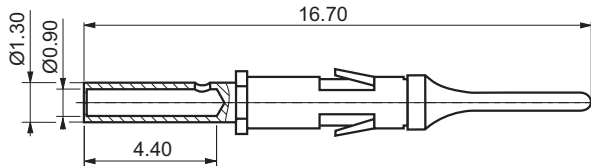

Reference	Part number
KN- ---13 20 ---	006 042 1- 20R OG
KN- ---55 20 --- MR	006 042 1- 20P OF 3401 017 004B

## Female

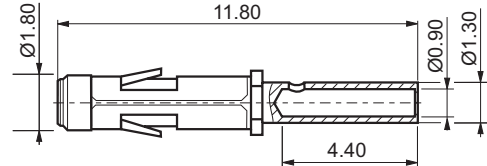

Reference	Part number
KN- ---22 20 ---	006 042 2- 20R GO
KN- ---44 20 --- FR	006 042 2- 20P J9 3401 017 015B

Crimp terminations AWG 22-28 (0.079 - 0.34 mm<sup>2</sup>) & Sheath Ø1.45

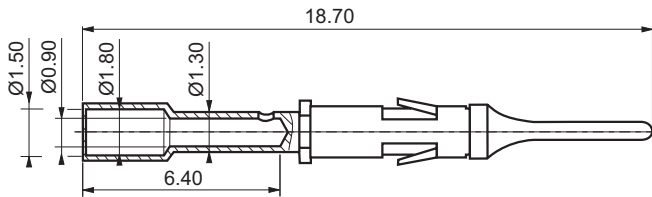

Reference	Part number
KN- ---13 20 ---	006 063 1- 21R OG
KN- ---55 20 ---	006 063 1- 20R OF

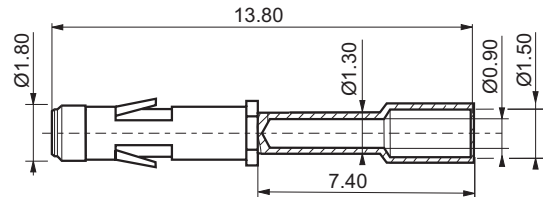

Reference	Part number
KN- ---22 20 ---	006 063 2- 21R GO
KN- ---44 20 ---	006 063 2- 21R J3

# Tools and accessories

## Crimp tool & Positioner



Ref: S\_102  
(M22520/2.01)



Contact part number	Crimp tool	AWG	Wire cross section	Positioner	Tool turret	Selector position
006 042 1- 20R OG 006 042 2- 20R GO	ASTRO TOOL M22520/2.01	28	0.079	SS-0060000001		3
		26	0.14			4
		24	0.20			4
		22	0.34			5
	DANIELS M22520/2.01	28	0.079	SS-0060000001		3
		26	0.14			4
		24	0.20			4
		22	0.34			5

006 063 1- 21R OG 006 063 2- 21R GO	2 operations	ASTRO TOOL M22520/2.01	28	0.079	SS-0060000001		3	
			26	0.14			4	
			24	0.20			4	
			22	0.34			5	
		1 <sup>st</sup> crimp (lead)	DANIELS M22520/2.01	28	0.079	SS-0060000001		3
				26	0.14			4
				24	0.20			4
				22	0.34			5
	2 <sup>nd</sup> crimp (sheath)	ASTRO TOOL M22520/2.01	28	0.079	SS-0060000002		*	
			26	0.14			6	
			24	0.20			7	
			22	0.34			7	
		DANIELS M22520/2.01	28	0.079	SS-0060000002		*	
			26	0.14			6	
			24	0.20			7	
			22	0.34			7	

	1 operation	52007	28	0.079		SP717	2
			26	0.14			3
			24	0.20			4
			22	0.34			4

### Insertion

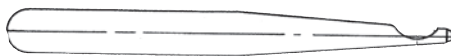

SM-0060000001

### Extraction

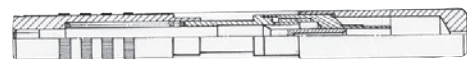

SD-0060000006

## Alignment Combs

for 90° through board termination

2 fixing points  
3 fixing points

HPF107/B  
SP. 006 00 00 004

## Screwdriver for m3 nut

208 locking devices  
215 locking devices

S\_075

# Accessories

## Antistatic Pin Protector

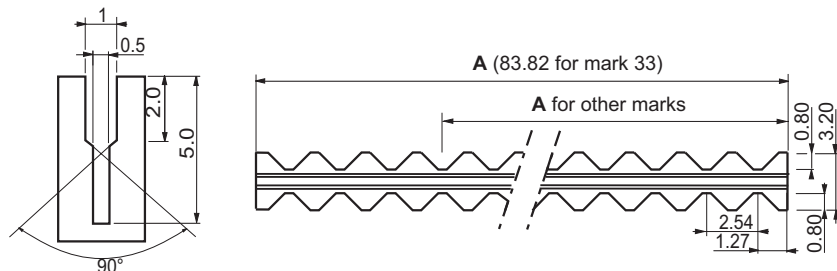

**Ordering information**  
**KNB - - - - 314**  
 ↑  
 Ref

Use	A	Ref	Use	A	Ref
KNB 017	24.13	<b>009</b>	KNB 096	62.23	<b>024</b>
KND 026			KND 144		
KNB 029 KND 044	39.37	<b>015</b>	KNB 053	69.85	<b>027</b>
			KNC 080 & 160		
			KND 080		
KNB 072 KND 108	46.99	<b>018</b>	KNB 120	77.47	<b>030</b>
KNB 041 & 084	54.61	<b>021</b>	KNB 065	83.82	<b>033</b>
KNC 062			KNC 098		
KND 062 & 126			KND 098		

**Note:** Each part number contains only one header.  
 To equip fully the connector, you have to order 2, 3, 4 or 6 identical headers.  
 Header can fit on contacts or be positioned between rows.



# Accessories

## Pin Protector (*extruded polypropylene*)

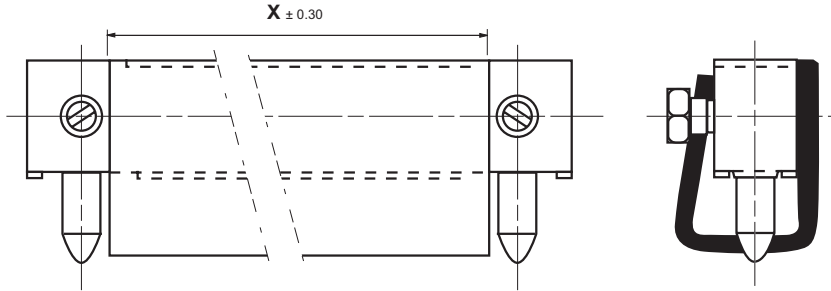

### Ordering information

**KN - - - - 308**  
 B, C or D      Number of positions

KNB	017	029	041	053	065	072	084	096	120
X ± 0.30	25.50	40.70	56	71.20	86.50	48.40	56	63.60	78.80
Qty	1	1	1	1	1	2	2	2	2

KNC	062	080	098	119	160
X ± 0.30	66	81.20	96.40	114.20	155.00
Qty	1	1	1	1	1

KND	026	044	108	126	144
X ± 0.30	35.50	50.70	111.70	127.00	142.20
Qty	1	1	1	1	1

# Technical Characteristics

Contact diameter	HYPERTAC® type Ø 0.50 mm
Number of contact	Up to 162
Pitch	1.905 mm between rows - 1.27 mm between quicuncial contacts
Rows	3

## Materials & Platings

Contact	Brass or bronze	
Molding	Glass fiber filled diallyl - Phtalate	
Guides	Stainless steel or nickel plated brass	
	<b>Standard</b>	<b>ESA</b>
Pin body	0.25 µm gold / 1.27 µm Ni	1.27 µm gold / 1.27 µm Ni (min.)
Socket body	0.25 µm gold / 1.27 µm Ni on active area 1.27 µm Ni on non active area	0.25 µm gold / 1.27 µm Ni (min.)
Socket wires	1 µm gold / 0.20 µm Ni	1.27 µm gold / 0.20 µm Ni (min.)

## Electrical

Current rating (at 25°C)	3 A max.
Dielectric withstanding voltage	800 Vrms
Contact resistance	≤8 mΩ
Insulation resistance	>104 MΩ (500 Vcc)

## Mechanical

Mating & unmating cycle	5000
Guiding	By two outside guides (2 guiding styles) and one central guide (3 guiding styles)
Keying	By rotating of outside polarized guides (up to 16 keying)

## Environmental

Temperature range	-55° C to 125° C
Conformity	ESA/ESCC3401/016 - 3401/017, NF C-UTE C 93-424

# How To Order



## Hypertac & ESA Correspondence Table

ESA 3401/039 01B



1 Series																																			
2 Number of contacts	0 2 6   0 4 4   0 6 2   0 8 0   0 9 8   1 4 4   1 6 2																																		
3 Molding polarity	<table border="1"> <thead> <tr> <th colspan="2">NF C-UTE C 93-424 ESA/ESCC 3401/03901B SPACE GRADE</th> <th colspan="2">NF C-UTE C 93-424 ESA/ESCC 3401/03901B SPACE GRADE</th> <th colspan="2">NF C-UTE C 93-424 ESA/ESCC 3401/03901B SPACE GRADE</th> </tr> </thead> <tbody> <tr> <td>12 - 54</td> <td>Female plug</td> <td>1A - -</td> <td>Tinned female plug**</td> <td>26 - 46</td> <td>Tinned female receptacle*</td> </tr> <tr> <td>13 55 55</td> <td>Male plug</td> <td>1B - -</td> <td>Tinned male plug**</td> <td>27 - 47</td> <td>Tinned male receptacle*</td> </tr> <tr> <td>16 - 56</td> <td>Tinned female plug*</td> <td>22 44 44</td> <td>Female receptacle</td> <td>2A - -</td> <td>Tinned female receptacle**</td> </tr> <tr> <td>17 - 57</td> <td>Tinned male plug*</td> <td>23 - 45</td> <td>Male receptacle</td> <td>2B - -</td> <td>Tinned male receptacle**</td> </tr> </tbody> </table>	NF C-UTE C 93-424 ESA/ESCC 3401/03901B SPACE GRADE		NF C-UTE C 93-424 ESA/ESCC 3401/03901B SPACE GRADE		NF C-UTE C 93-424 ESA/ESCC 3401/03901B SPACE GRADE		12 - 54	Female plug	1A - -	Tinned female plug**	26 - 46	Tinned female receptacle*	13 55 55	Male plug	1B - -	Tinned male plug**	27 - 47	Tinned male receptacle*	16 - 56	Tinned female plug*	22 44 44	Female receptacle	2A - -	Tinned female receptacle**	17 - 57	Tinned male plug*	23 - 45	Male receptacle	2B - -	Tinned male receptacle**				
NF C-UTE C 93-424 ESA/ESCC 3401/03901B SPACE GRADE		NF C-UTE C 93-424 ESA/ESCC 3401/03901B SPACE GRADE		NF C-UTE C 93-424 ESA/ESCC 3401/03901B SPACE GRADE																															
12 - 54	Female plug	1A - -	Tinned female plug**	26 - 46	Tinned female receptacle*																														
13 55 55	Male plug	1B - -	Tinned male plug**	27 - 47	Tinned male receptacle*																														
16 - 56	Tinned female plug*	22 44 44	Female receptacle	2A - -	Tinned female receptacle**																														
17 - 57	Tinned male plug*	23 - 45	Male receptacle	2B - -	Tinned male receptacle**																														
4 Termination styles	<table border="1"> <tbody> <tr> <td>10 90° length 3 mm ("A" molding)</td> <td>30 Through board solder - straight - length 4.5 mm</td> <td>51 Wire wrap (3 wrapping levels)</td> </tr> <tr> <td>10 90° length 3 mm ("B" molding)</td> <td>31 Through board solder - straight - length 5.6 mm</td> <td>90 Male - Female</td> </tr> <tr> <td>11 90° length 4 mm ("A" molding)</td> <td>40 Solder bucket</td> <td>91 Female - male</td> </tr> <tr> <td>13 90° length 5.5 mm ("B" molding)</td> <td>50 Wire wrap (2 wrapping levels)</td> <td></td> </tr> </tbody> </table>	10 90° length 3 mm ("A" molding)	30 Through board solder - straight - length 4.5 mm	51 Wire wrap (3 wrapping levels)	10 90° length 3 mm ("B" molding)	31 Through board solder - straight - length 5.6 mm	90 Male - Female	11 90° length 4 mm ("A" molding)	40 Solder bucket	91 Female - male	13 90° length 5.5 mm ("B" molding)	50 Wire wrap (2 wrapping levels)																							
10 90° length 3 mm ("A" molding)	30 Through board solder - straight - length 4.5 mm	51 Wire wrap (3 wrapping levels)																																	
10 90° length 3 mm ("B" molding)	31 Through board solder - straight - length 5.6 mm	90 Male - Female																																	
11 90° length 4 mm ("A" molding)	40 Solder bucket	91 Female - male																																	
13 90° length 5.5 mm ("B" molding)	50 Wire wrap (2 wrapping levels)																																		
5 Mounting hardware	<p><b>Guide Styles (consult us for special guides)</b></p> <table border="1"> <tbody> <tr> <td>110 Male polarized, transverse mount<sup>(1)</sup></td> <td>127 Male unpolarized, vertical mount<sup>(2)</sup></td> <td>156 Male unpolarized, transverse mount<sup>(2)</sup></td> </tr> <tr> <td>111 Male polarized, vertical mount<sup>(2)</sup></td> <td>128 Male unpolarized, float mount<sup>(2)</sup></td> <td>173 Female unpolarized, transverse mount<sup>(1)</sup></td> </tr> <tr> <td>112 Male polarized, vertical mount<sup>(2)</sup></td> <td>130 Female unpolarized, vertical mount<sup>(2)</sup></td> <td>174 Female polarized, transverse mount<sup>(1)</sup></td> </tr> <tr> <td>113 Male polarized, float mount<sup>(2)</sup></td> <td>133 Female unpolarized, transverse mount<sup>(2)</sup></td> <td>190 Female power or mass contact, vertical mount<sup>(2)</sup></td> </tr> <tr> <td>121 Female polarized, vertical mount<sup>(2)</sup></td> <td>143 Female polarized, vertical mount<sup>(2)</sup></td> <td>191 Male power or mass contact, transverse mount<sup>(1)</sup></td> </tr> <tr> <td>123 Female polarized, float mount<sup>(2)</sup></td> <td>153 Female unpolarized, transverse mount<sup>(2)</sup></td> <td>703 Female - male unpolarized guide <sup>(1)</sup></td> </tr> <tr> <td>124 Female polarized, transverse mount<sup>(2)</sup></td> <td>154 Female polarized, transverse mount<sup>(2)</sup></td> <td></td> </tr> <tr> <td>125 Male unpolarized, transverse mount<sup>(1)</sup></td> <td>155 Male unpolarized, transverse mount<sup>(2)</sup></td> <td></td> </tr> </tbody> </table> <p><b>Locking Styles</b></p> <table border="1"> <thead> <tr> <th>FEMALE</th> <th>MALE</th> </tr> </thead> <tbody> <tr> <td>202 Jackscrew, vertical mount<sup>(2)</sup></td> <td>201 Jackscrew, free connector<sup>(2)</sup></td> </tr> <tr> <td>203 Jackscrew, transverse mount</td> <td>205 Jackscrew, transverse mount<sup>(1)</sup></td> </tr> <tr> <td>204 Jackscrew, transverse mount<sup>(2)</sup></td> <td>206 Jackscrew, free connector<sup>(2)</sup></td> </tr> <tr> <td>207 Jackscrew, vertical mount<sup>(2)</sup></td> <td></td> </tr> </tbody> </table>	110 Male polarized, transverse mount <sup>(1)</sup>	127 Male unpolarized, vertical mount <sup>(2)</sup>	156 Male unpolarized, transverse mount <sup>(2)</sup>	111 Male polarized, vertical mount <sup>(2)</sup>	128 Male unpolarized, float mount <sup>(2)</sup>	173 Female unpolarized, transverse mount <sup>(1)</sup>	112 Male polarized, vertical mount <sup>(2)</sup>	130 Female unpolarized, vertical mount <sup>(2)</sup>	174 Female polarized, transverse mount <sup>(1)</sup>	113 Male polarized, float mount <sup>(2)</sup>	133 Female unpolarized, transverse mount <sup>(2)</sup>	190 Female power or mass contact, vertical mount <sup>(2)</sup>	121 Female polarized, vertical mount <sup>(2)</sup>	143 Female polarized, vertical mount <sup>(2)</sup>	191 Male power or mass contact, transverse mount <sup>(1)</sup>	123 Female polarized, float mount <sup>(2)</sup>	153 Female unpolarized, transverse mount <sup>(2)</sup>	703 Female - male unpolarized guide <sup>(1)</sup>	124 Female polarized, transverse mount <sup>(2)</sup>	154 Female polarized, transverse mount <sup>(2)</sup>		125 Male unpolarized, transverse mount <sup>(1)</sup>	155 Male unpolarized, transverse mount <sup>(2)</sup>		FEMALE	MALE	202 Jackscrew, vertical mount <sup>(2)</sup>	201 Jackscrew, free connector <sup>(2)</sup>	203 Jackscrew, transverse mount	205 Jackscrew, transverse mount <sup>(1)</sup>	204 Jackscrew, transverse mount <sup>(2)</sup>	206 Jackscrew, free connector <sup>(2)</sup>	207 Jackscrew, vertical mount <sup>(2)</sup>	
110 Male polarized, transverse mount <sup>(1)</sup>	127 Male unpolarized, vertical mount <sup>(2)</sup>	156 Male unpolarized, transverse mount <sup>(2)</sup>																																	
111 Male polarized, vertical mount <sup>(2)</sup>	128 Male unpolarized, float mount <sup>(2)</sup>	173 Female unpolarized, transverse mount <sup>(1)</sup>																																	
112 Male polarized, vertical mount <sup>(2)</sup>	130 Female unpolarized, vertical mount <sup>(2)</sup>	174 Female polarized, transverse mount <sup>(1)</sup>																																	
113 Male polarized, float mount <sup>(2)</sup>	133 Female unpolarized, transverse mount <sup>(2)</sup>	190 Female power or mass contact, vertical mount <sup>(2)</sup>																																	
121 Female polarized, vertical mount <sup>(2)</sup>	143 Female polarized, vertical mount <sup>(2)</sup>	191 Male power or mass contact, transverse mount <sup>(1)</sup>																																	
123 Female polarized, float mount <sup>(2)</sup>	153 Female unpolarized, transverse mount <sup>(2)</sup>	703 Female - male unpolarized guide <sup>(1)</sup>																																	
124 Female polarized, transverse mount <sup>(2)</sup>	154 Female polarized, transverse mount <sup>(2)</sup>																																		
125 Male unpolarized, transverse mount <sup>(1)</sup>	155 Male unpolarized, transverse mount <sup>(2)</sup>																																		
FEMALE	MALE																																		
202 Jackscrew, vertical mount <sup>(2)</sup>	201 Jackscrew, free connector <sup>(2)</sup>																																		
203 Jackscrew, transverse mount	205 Jackscrew, transverse mount <sup>(1)</sup>																																		
204 Jackscrew, transverse mount <sup>(2)</sup>	206 Jackscrew, free connector <sup>(2)</sup>																																		
207 Jackscrew, vertical mount <sup>(2)</sup>																																			

**(1) Molding A - (2) Molding B**

- \* For 90° & straight terminations (splicing on PCB) -
- \*\* RoHS compliant for 90° & straight terminations (splicing on PCB)

# Molding Styles

## Plug

### One Part (molding A)

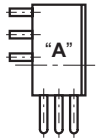

- Fitted with male contacts**
- 90° through board solder

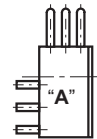

- Fitted with male contacts**
- 90° through board solder  
*(same design as the "A" plug type but printed as receptacle)*

### Two Parts (molding B)

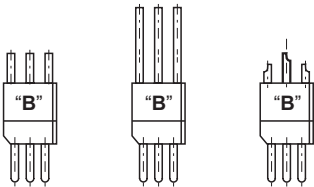

- Fitted with male contacts (pins)**
- Straight through board solder
  - Wire wrap type  
*(2 and 3 wrapping levels)*
  - Solder bucket

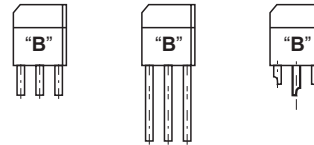

- Fitted with female contacts**
- Straight through board solder
  - Wire wrap type  
*(2 and 3 wrapping levels)*
  - Solder bucket  
*(same design as the "B" plug type but printed as receptacle)*

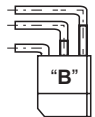

- Fitted with female contacts (sockets)**
- 90° through board solder  
*Note: the spacing of the rows for board preparation is different to the spacing of the plug fitted with the 90° termination*

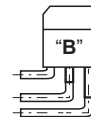

- Fitted with female contacts (sockets)**
- 90° through board solder  
*Note: the spacing of the rows for board preparation is different to the spacing of the plug fitted with the 90° termination*

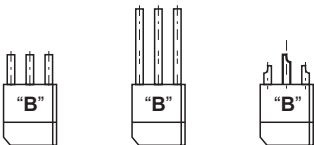

- Fitted with male contacts (pins)**
- Straight through board solder
  - Wire wrap type  
*(2 and 3 wrapping levels)*
  - Solder bucket

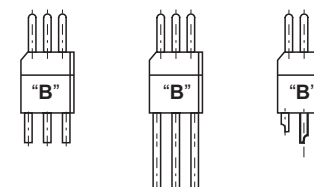

- Fitted with male contacts (pins)**
- Straight through board solder
  - Wire wrap type  
*(2 and 3 wrapping levels)*
  - Solder bucket  
*(same design as the "B" plug type but printed as receptacle)*

# Contact Terminations

## Plug

## Receptacle

Male

Female

Female

Male

### 90° Through board solder

Ref: 10 Ref : 10 (only A Molding)

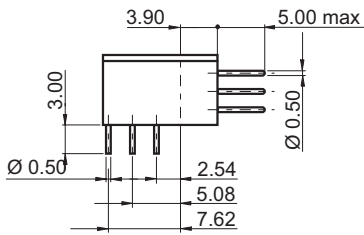

Moulding "A"

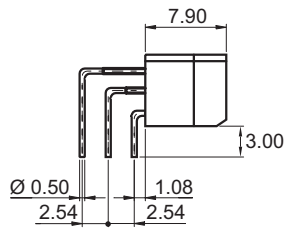

Moulding "B"

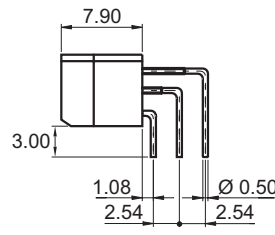

Moulding "B"

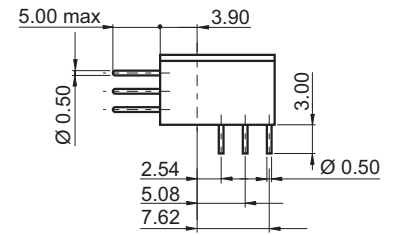

Moulding "A"

### 90° through board solder

Moulding A Ref: 11 (X=4.00) Moulding B Ref: 13 (X=5.50)

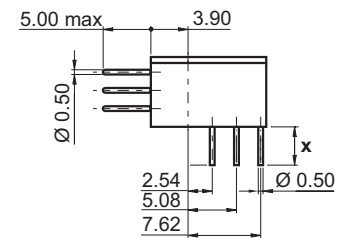
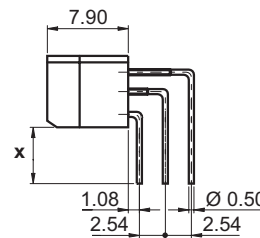
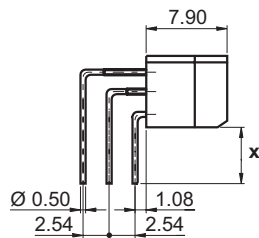
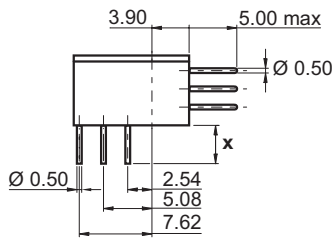

### Straight through board solder

Ref: 30 (X=4.50) Ref : 30 Ref: 31 (X=5.60) Ref : 31

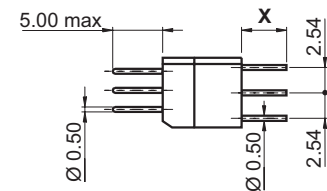
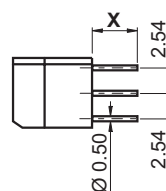
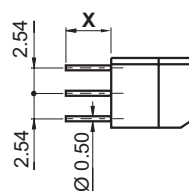
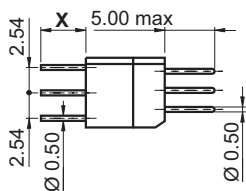

### Solder bucket (AWG 26 max)

Ref: 40 Ref : 40

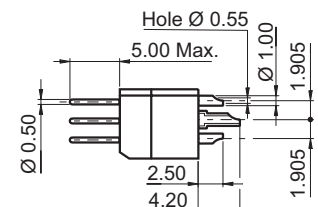
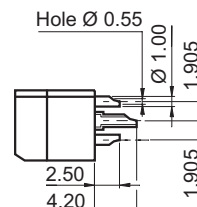
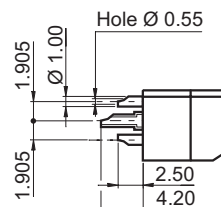
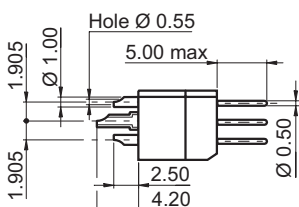

Note: molding A and B need different preparation board details for 90° tail termination.

# Contact Terminations

## Plug

Male

Female

## Receptacle

Female

Male

### Wire wrap (2 wrapping levels)

Ref: **50** Ref : **50**

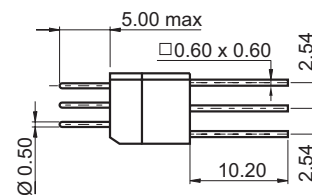
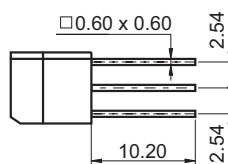
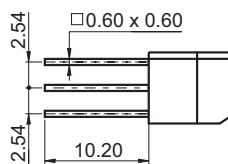
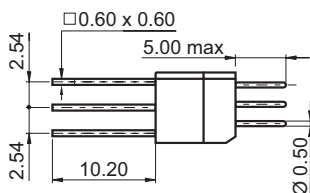

### Wire wrap (3 wrapping levels)

Ref: **51** Ref : **51**

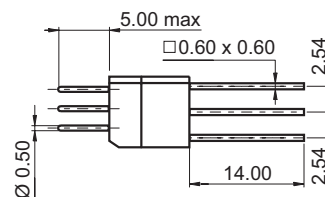
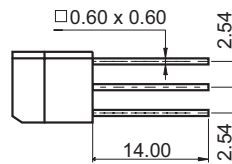
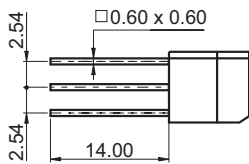
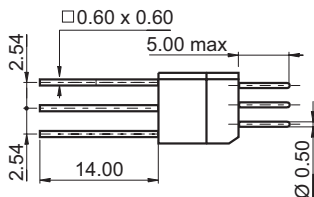

### Saver (Male-Male)

Ref: **90**

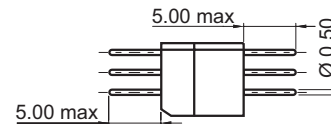
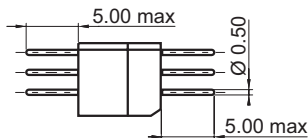

### Saver (Female-Male)

Ref: **91** Ref : **91**

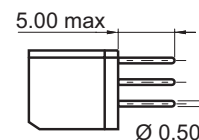
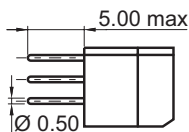

**Note:** molding A and B need different preparation board details for 90° tail termination.

# Dimensions

## 26 to 98 Contacts

## 144 to 162 Contacts

### One Part (molding A)

90° male plug KMC ... 13 10 ...

90° male receptacle KMC ... 23 10 ...

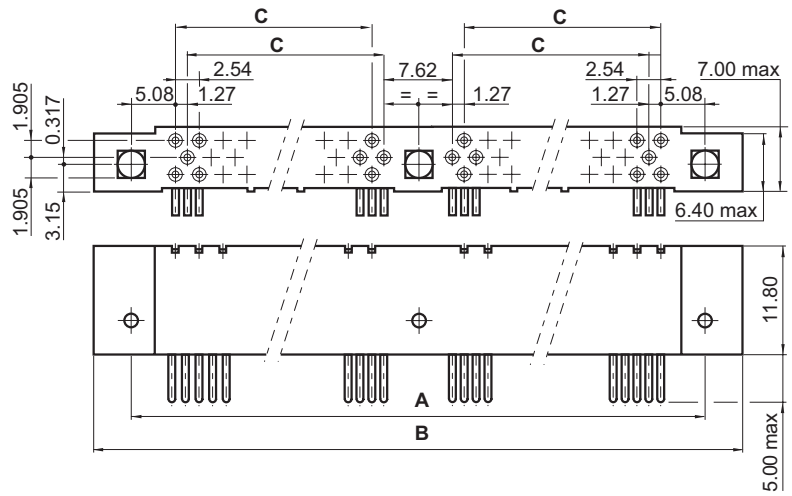
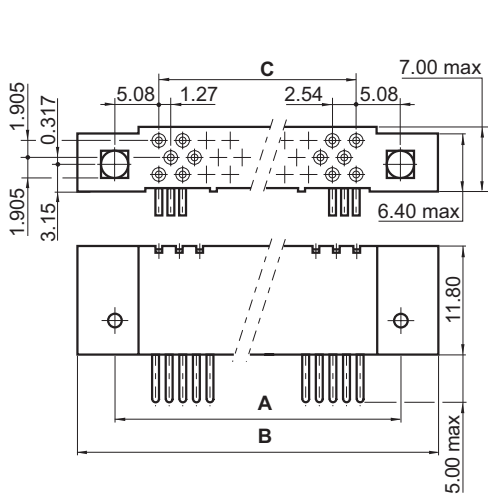

### Two parts (molding B)

Female or male receptacle KMC ... 2 ...

Female or male plug KMC ... 1 ...

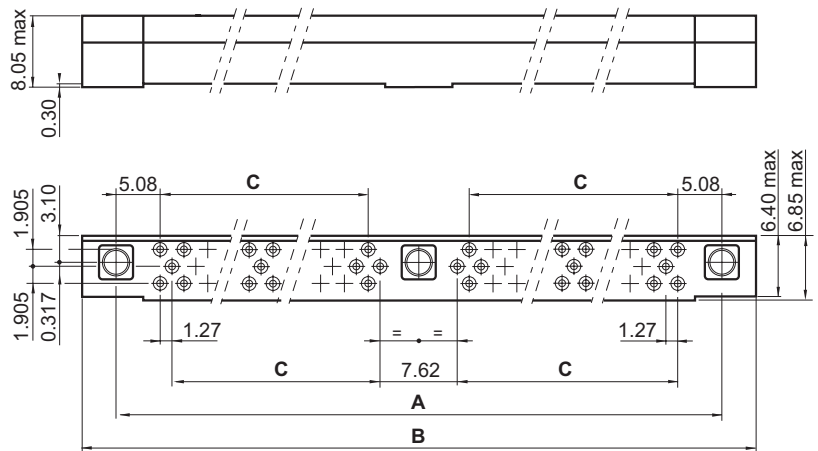
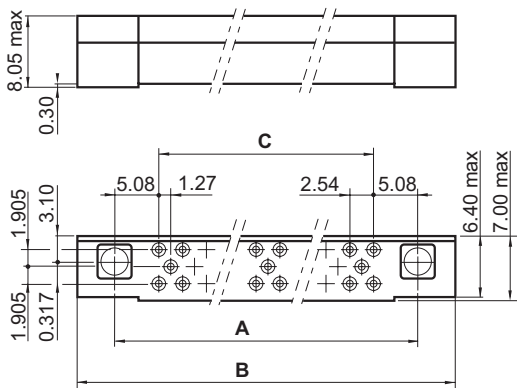

No. of contacts	26	44	62	80	98	144	162
A	30.48	45.72	60.96	76.20	91.44	137.16	152.40
B max	38.50	53.70	69.00	84.20	99.50	145.20	160.40
C	20.32	35.56	50.80	66.04	81.28	58.42	66.04





# Male Guide Styles

## Polarized transverse mount (molding A)

Ref: 110 Ref:  110

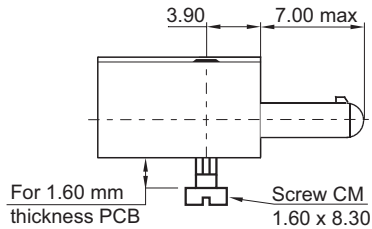

## Unpolarized transverse mount (molding A) central guide (KMC 144-162)

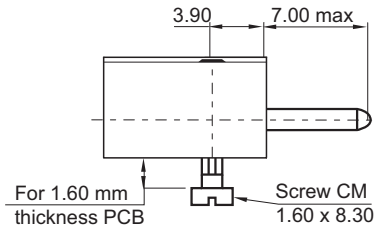

## Polarized vertical mount (molding B)

Ref: 111 Ref: 112

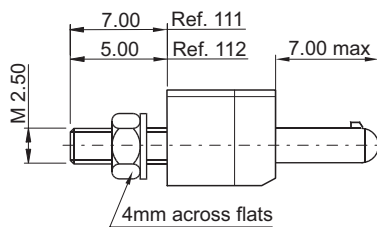

## Unpolarized vertical mount (molding B) central guide (KMC 144-162)

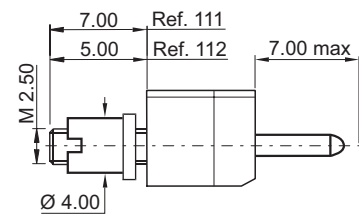

## Polarized vertical float mount (molding B)

ref: 113

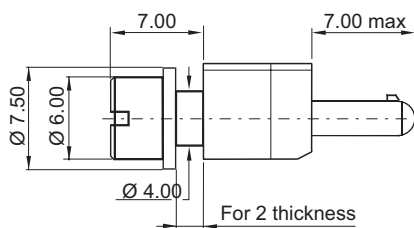

## Unpolarized vertical float mount (molding B) central guide (KMC 144-162)

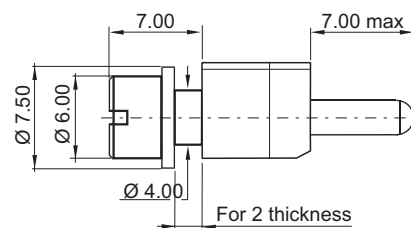

## Polarized vertical float mount (molding B)

Ref: 128

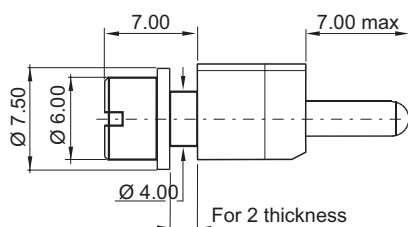

# Male Guide Styles

Unpolarized transverse mount (molding A)

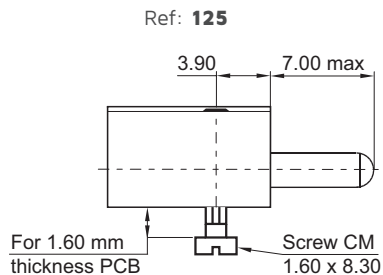

Unpolarized transverse mount (molding A) central guide (KMC 144-162)

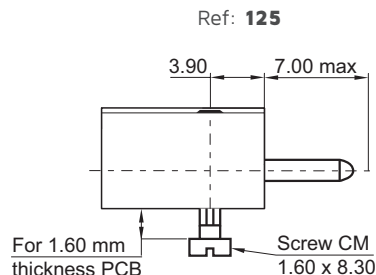

Unpolarized vertical mount (molding B)

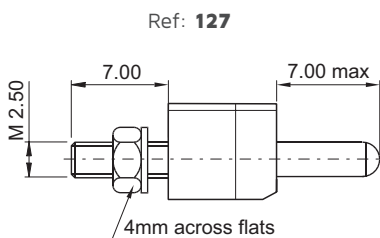

Unpolarized vertical mount (molding B) central guide (KMC 144-162)

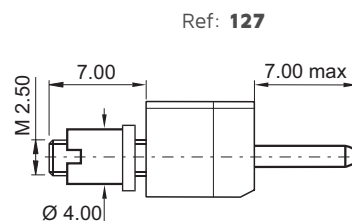

Unpolarized transverse mount (molding B)

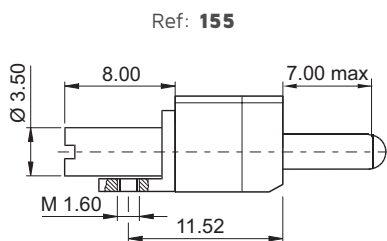

Unpolarized transverse mount (molding B) central guide (KMC 144-162)

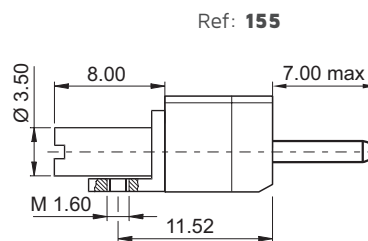

Polarized transverse mount (molding B)

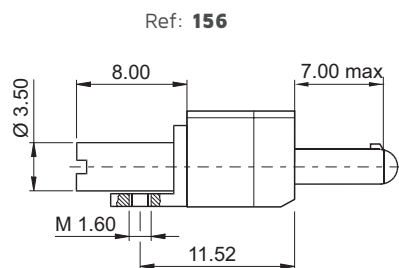

Unpolarized transverse mount (molding B) central guide (KMC 144-162)

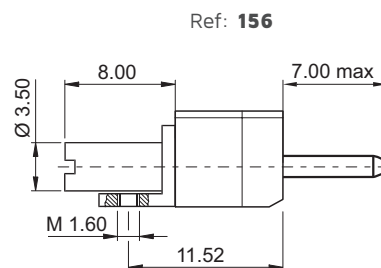

# Female Guide Styles

## Polarized vertical mount (molding B)

Ref: 121 Ref: 143 Ref: 143

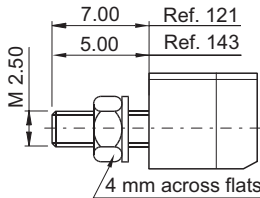

## Unpolarized vertical mount (molding B) central guide (KMC 144-162)

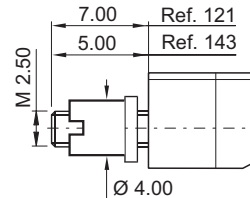

## Polarized transverse mount (molding B)

Ref: 124

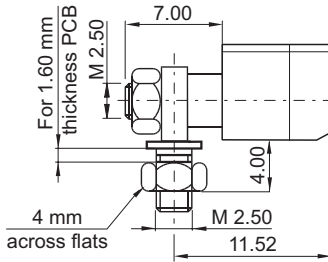

## Unpolarized transverse mount (molding B) central guide (KMC 144-162)

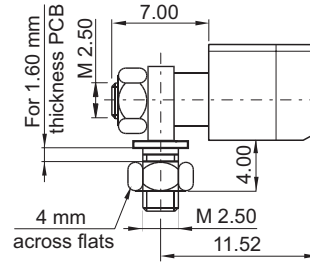

## Unpolarized vertical float mount (molding B)

Ref: 123

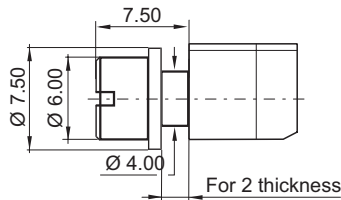

## All keying types (molding B)

Ref: 130

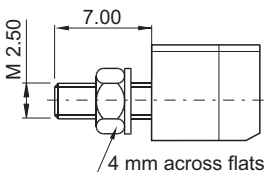

## All keying types (molding B) central guide (KMC 144-162)

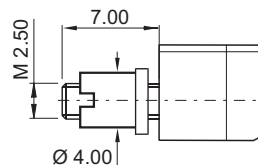

# Female Guide Styles

All keying types  
(molding B)

Ref: 133

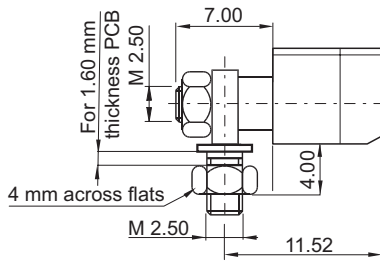

All keying types  
(molding B) central guide (KMC 144-162)

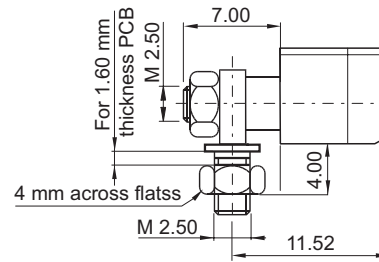

All keying types  
(molding B)

Ref: 153

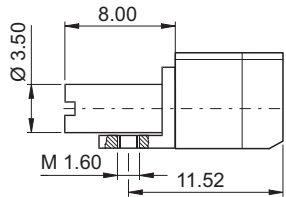

All keying types  
(molding B) central guide (KMC 144-162)

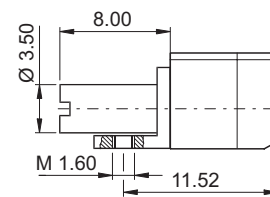

Polarized transverse mount  
(molding B)

Ref: 154

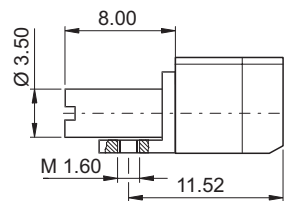

Unpolarized transverse mount  
(molding B)  
central guide (KMC 144-162)

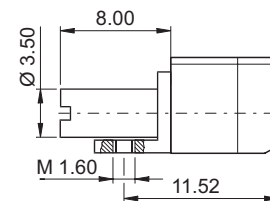

# Guide Styles

## Female

Unpolarized transverse mount  
(molding A)

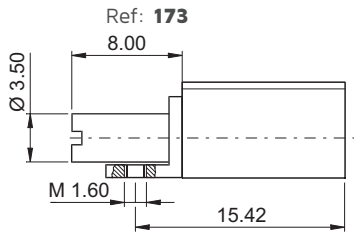

Polarized transverse mount  
(molding A)

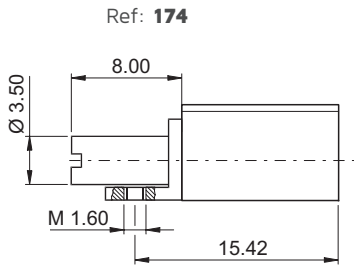

## Female

Mass and power contact  
(molding B)

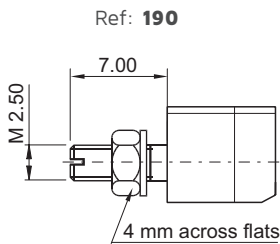

## Male

Mass and power contact  
(molding A)

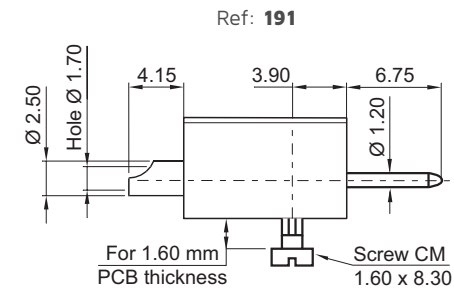

## Female - Male

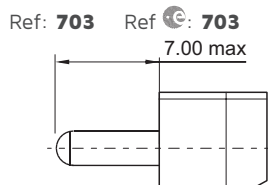

Unpolarized transverse mount  
(molding B)

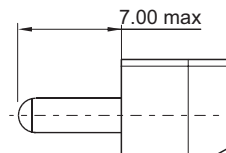

Unpolarized transverse mount  
(molding B) central guide (KMC 144-162)

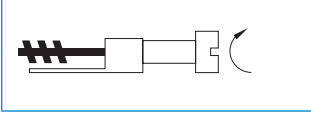
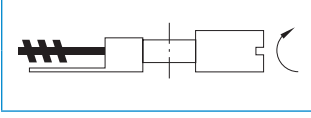
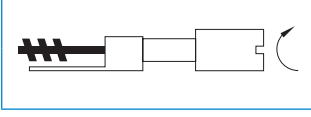
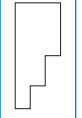
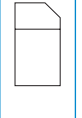
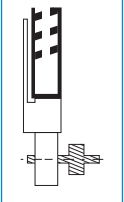
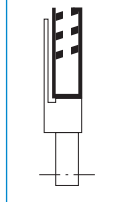
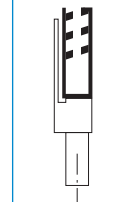

# Locking Device Compatibility chart

						A	Molding
						B	
							206
							205
							201
					Male locking devices		
A	B				Female locking devices		
Molding		204	203	202/207			

Compatible

**Note:** the connector must be fitted with its locking devices before soldering on the PCB (straight through board solder):

- Connector on PCB: impossibility to change the keying.
  - If you need to change the keying:
    - pierce PCB through  $\varnothing 3.70$ , fixing devices
    - use 054826.000R shouldered washer
- } (for 202 and 207)

# Locking Styles

## Male

### Jackscrew, free connector (molding B)

Ref: **201** Ref:  **201**

For **KMC 144-162** the supplied central guide is Ref: **111**

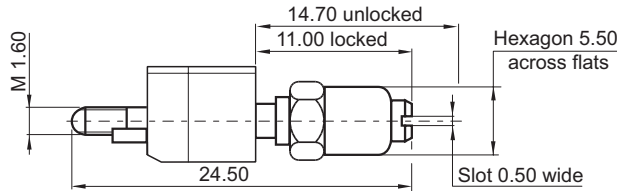

### Jackscrew, transverse mount (molding A)

Ref: **205**

For **KMC 144-162** the supplied central guide is Ref: **110**

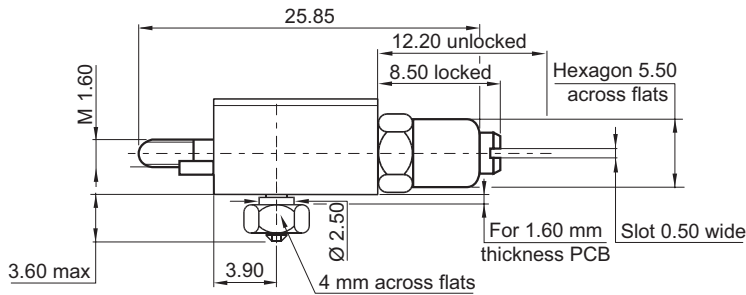

### Jackscrew, free connector (molding B)

Ref: **206** Ref:  **206**

For **KMC 144-162** the supplied central guide is Ref: **112**

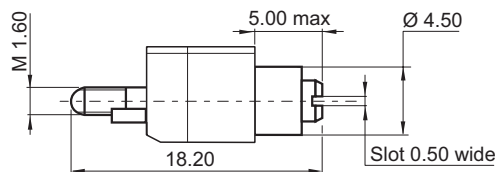

# Locking Styles

## Female

### Non rotating jackscrew, vertical mount (molding B)

Ref: **202** Ref: **202**

For **KMC 144-162** jackscrew 202 the supplied central guide is Ref: **121**

Ref: **207**

jackscrew 207 the supplied central guide is Ref: **143**

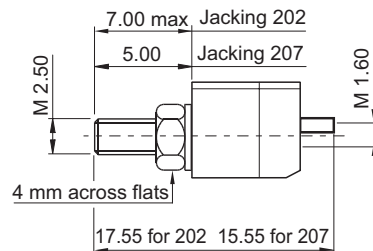

### Non rotating jackscrew, transverse mount (molding A)

Ref: **203**

For **KMC 144-162** jackscrew 202 the supplied central guide is Ref: **173**

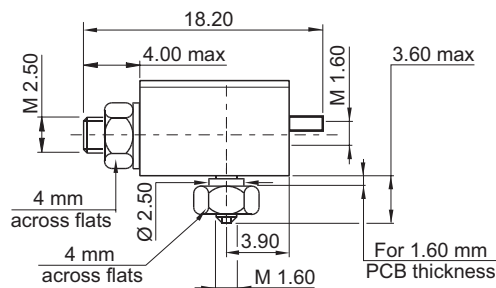

### Non rotating jackscrew, transverse mount (molding B)

Ref: **204** Ref: **204**

For **KMC 144-162** the supplied central guide is Ref: **111**

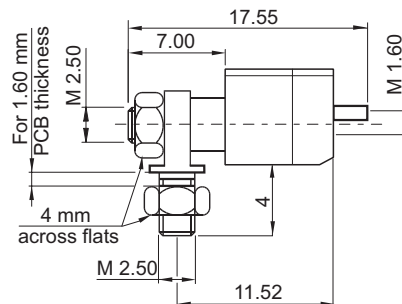



# Mating Side Layout View

## Molding A

Plug

Receptacle



026

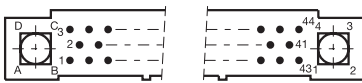
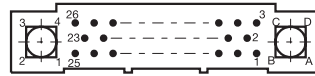

044

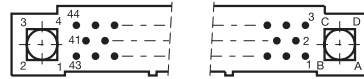

062



080

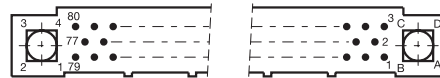

098

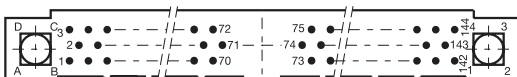

144



162

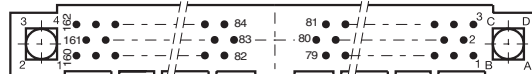

# Mating Side Layout View

## Male plug only

Plug

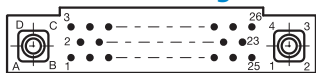

026

Receptacle

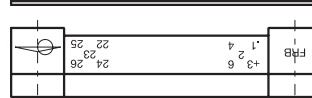
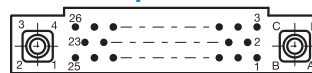

044

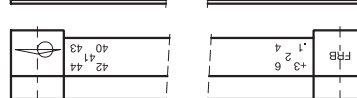
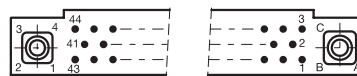

062



080



098

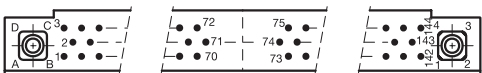
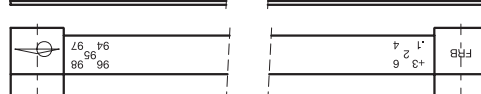

144

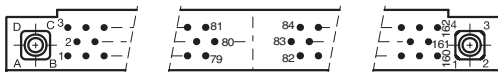
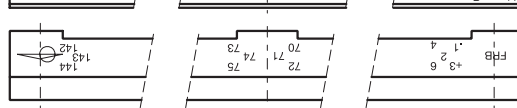
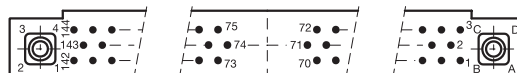

162

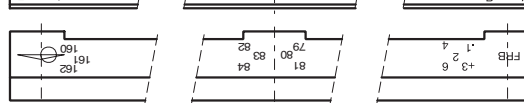
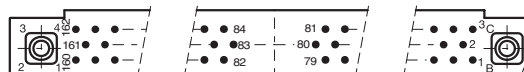

# Board Preparation Details

## Two Parts (molding B)

26 to 98 contacts

144 to 162 contacts

### Mother board

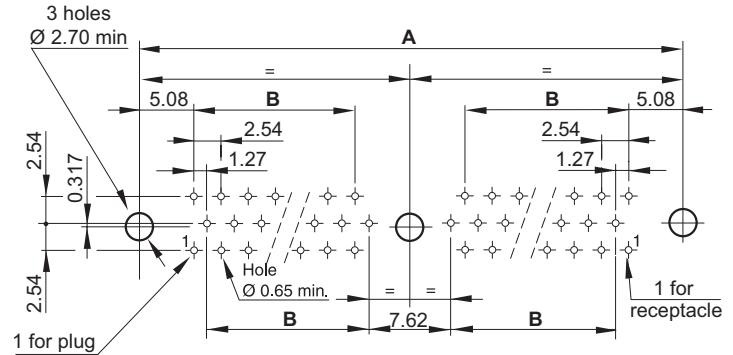
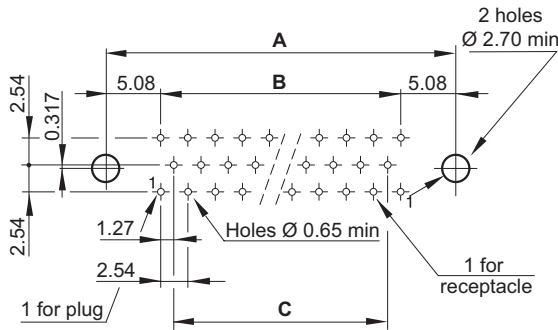

Female or male, plug or receptacle, straight solder terminations 30 or 31

**Guide styles:** 111 - 112 - 121 - 127 - 130 - 143 - 190

### Daughter board

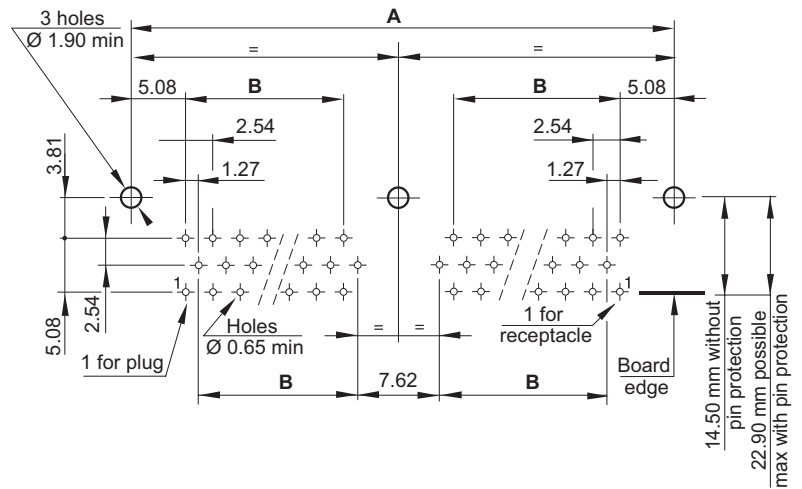
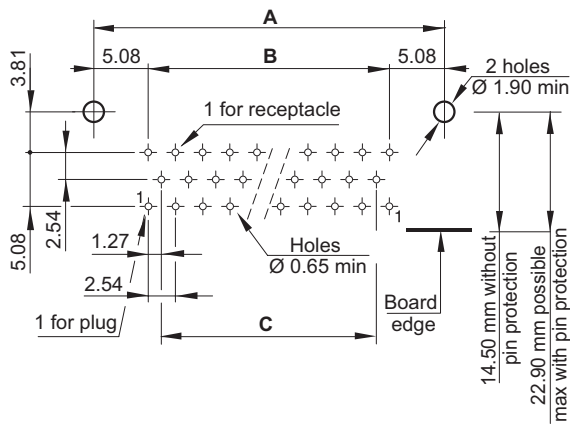

Female or male, plug or receptacle, 90° termination

**Guide styles:** 153 - 154 - 155 - 156

No. of contacts	26	44	62	80	98	144	162
A	30.48	45.72	60.96	76.20	91.44	137.16	152.40
B	20.32	35.56	50.80	66.04	81.28	58.42	66.04
C	17.78	33.02	48.26	63.50	78.74	-	-

# Board Preparation Details

## Two Parts (molding B)

26 to 98 contacts

144 to 162 contacts

Daughter board

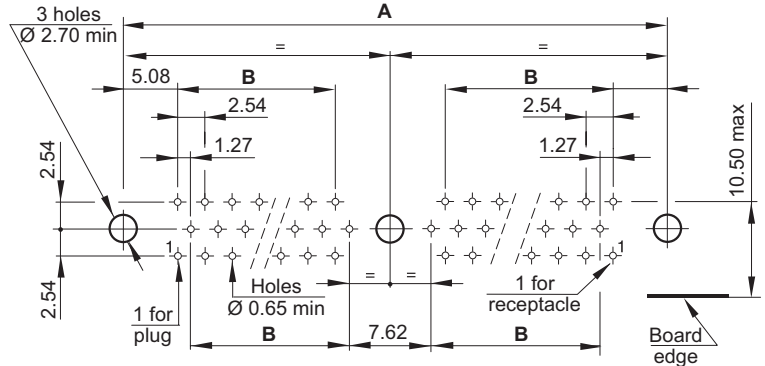
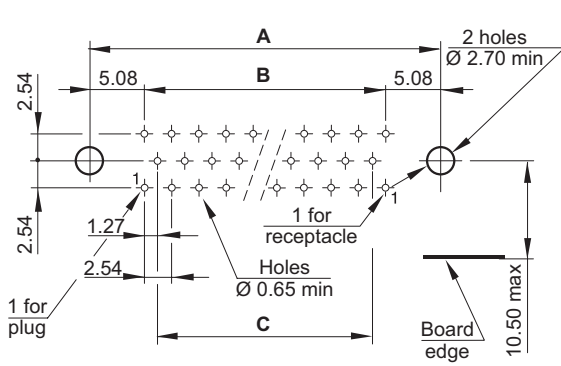

Female or male, plug or receptacle, 90° termination

**Guide styles:** 124 - 133

No. of contacts	26	44	62	80	98	144	162
A	30.48	45.72	60.96	76.20	91.44	137.16	152.40
B	20.32	35.56	50.80	66.04	81.28	58.42	66.04
C	17.78	33.02	48.26	63.50	78.74	-	-

# Board Preparation Details

## One Part (molding A)

Daughter board

26 to 98 Contacts

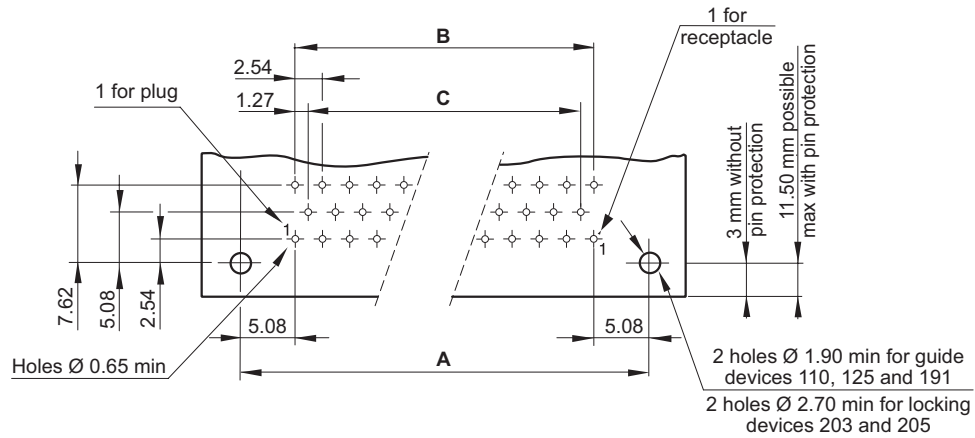

Male, plug or receptacle, 90° termination  
**Guide styles:** 110 - 125 - 191 - 203 - 205

## 144 to 162 Contacts

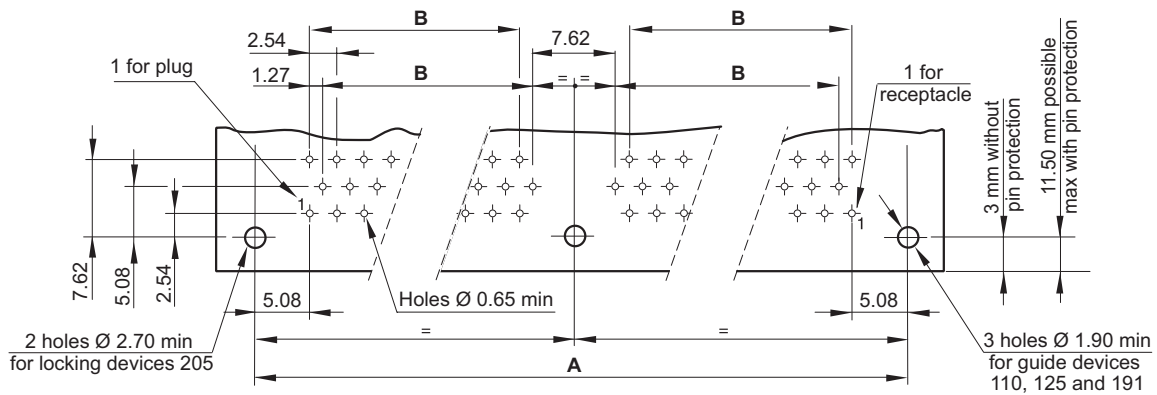

Male, plug or receptacle, 90° termination  
**Guide styles:** 110 - 125 - 191 - 205

No. of contacts	26	44	62	80	98	144	162
A	30.48	45.72	60.96	76.20	91.44	137.16	152.40
B	20.32	35.56	50.80	66.04	81.28	58.42	66.04
C	17.78	33.02	48.26	63.50	78.74	-	-

# Board Preparation Details

## One Part (molding A)

Daughter board

144 to 162 Contacts

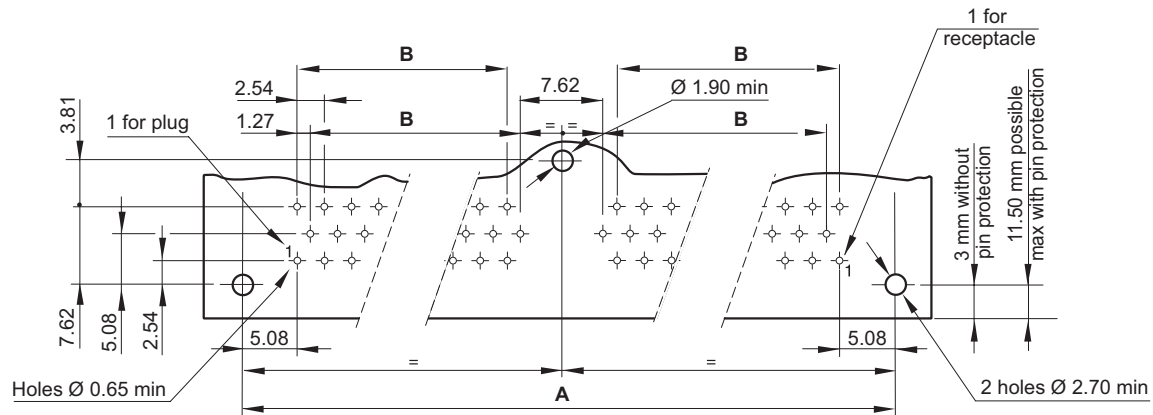

Male, plug or receptacle, 90° termination

**Locking styles: 203**

No. of contacts	26	44	62	80	98	144	162
A	30.48	45.72	60.96	76.20	91.44	137.16	152.40
B	20.32	35.56	50.80	66.04	81.28	58.42	66.04
C	17.78	33.02	48.26	63.50	78.74	-	-

# Panel Preparation Details

## Two Parts (molding B)

26 to 98 contacts

144 to 162 contacts

### Mother board

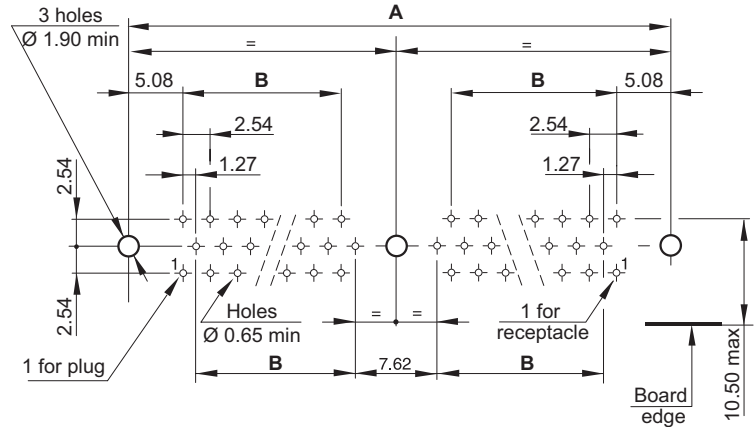
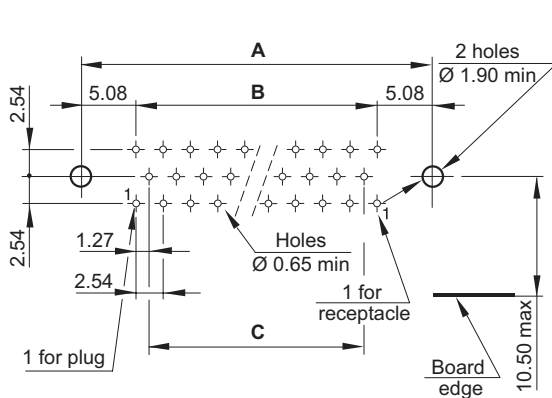

Plug or receptacle, 90° termination  
**Guide styles:** 153 - 154 - 155 - 156

### Daughter board

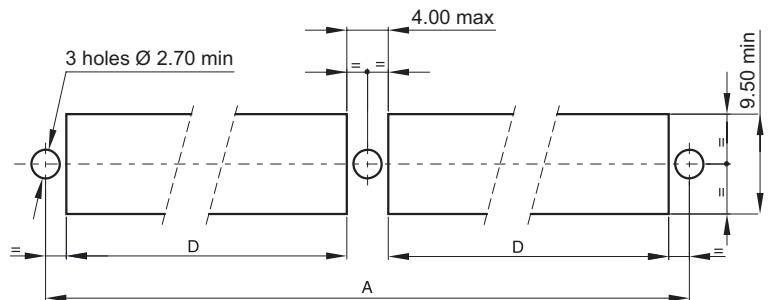
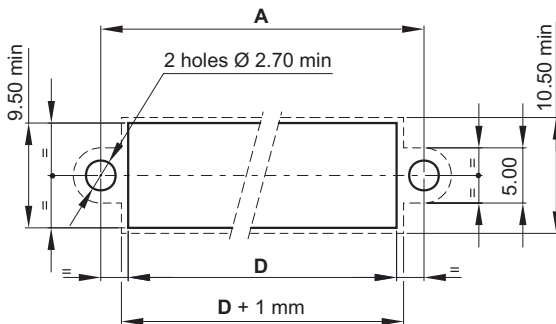

Female or male, plug or receptacle, 90° termination 40 - 50 - 51  
**Guide styles:** 111 - 112 - 121 - 127 -130 - 143 - 190 - (Fixed Mount)  
**Guide styles:** 113 - 123 - 128 - (Float Mount)  
**Locking Styles:** 202 - 207

No. of contacts	26	44	62	80	98	144	162
A	30.48	45.72	60.96	76.20	91.44	137.16	152.40
B	20.32	35.56	50.80	66.04	81.28	58.42	66.04
C	17.78	33.02	48.26	63.50	78.74	-	-
D	25.90	41.20	56.40	71.60	86.90	63.60	71.60

# Technical Characteristics

	Signal contact	Power contact	High frequency contact
Contact diameter	HC® Ø 0.50 mm	HC® Ø 2.00 mm	HE 807 type
Number of contact	Up to 162		
Pitch	1.905 mm between rows 1.27 mm between quicuncial contacts	5.08 on 1 row	
Rows	3		

## Electrical

Current rating (at 25°C)	3 A max.	15 A	0.5 A
Dielectric withstanding voltage	800 Vrms		
Nominal voltage			180 Vrms 50 Hz
Impedance			50 Ω
Contact resistance	≤8 mΩ	≤2 mΩ	≤10 mΩ
Insulation resistance	104 MΩ (500 Vcc)		≥107 MΩ

## Environmental

Temperature range		-55°C to 125°C	
Mating forces		FI ≤8N - FS ≤3N	1N ≤FI/FS ≤5N
Conformity		NF C-UTE C 93-424	

## Materials & Platings

Contact	Brass or bronze		
Molding	Glass fiber filled diallyl - Phtalate		
Guides	Stainless steel or nickel plated brass		
	<b>Standard</b>	<b>ESA</b>	
Pin body	0.25 μm gold / 1.27 μm Ni	1.27 μm gold / 1.27 μm Ni (min)	
Socket body	0.25 μm gold / 1.27 μm Ni on active area 1.27 μm Ni on active area	0.25 μm gold / 1.27 μm Ni (min)	
Socket wires	1 μm gold / 0.20 μm Ni	1.27 μm gold / 0.20 μm Ni (min)	

## Mechanical

Mating & unmating cycle	5000
Guiding	By two outside guides (2 guiding styles) and one central guide (3 guiding styles)
Keying	By rotating of outside polarized guides (up to 16 keying)



# How To Order

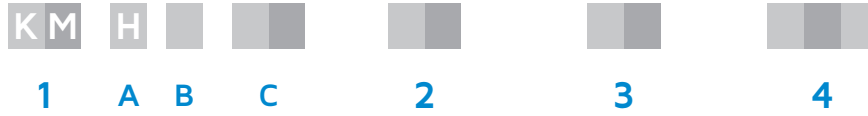

<p><b>1</b> Type</p>	<p><b>A</b> <b>H</b> Moulding with cavities for special contacts  <b>B</b> <b>3</b> <b>6</b> Number of cavities for special contacts  <b>C</b> <b>2 6</b> <b>4 4</b> <b>8 0</b> <b>9 0</b> Number of signal contacts 0.50 mm</p>																														
<p><b>2</b> Molding polarity</p>	<table border="1"> <thead> <tr> <th colspan="2">NF C-UTE C 93-424 SPACE GRADE</th> <th colspan="2">NF C-UTE C 93-424 SPACE GRADE</th> <th colspan="2">NF C-UTE C 93-424 SPACE GRADE</th> </tr> </thead> <tbody> <tr> <td>12</td><td>54</td><td>1A</td><td>-</td><td>26</td><td>46</td> </tr> <tr> <td>13</td><td>55</td><td>1B</td><td>-</td><td>27</td><td>47</td> </tr> <tr> <td>16</td><td>56</td><td>22</td><td>44</td><td>2A</td><td>-</td> </tr> <tr> <td>17</td><td>57</td><td>23</td><td>45</td><td>2B</td><td>-</td> </tr> </tbody> </table>	NF C-UTE C 93-424 SPACE GRADE		NF C-UTE C 93-424 SPACE GRADE		NF C-UTE C 93-424 SPACE GRADE		12	54	1A	-	26	46	13	55	1B	-	27	47	16	56	22	44	2A	-	17	57	23	45	2B	-
NF C-UTE C 93-424 SPACE GRADE		NF C-UTE C 93-424 SPACE GRADE		NF C-UTE C 93-424 SPACE GRADE																											
12	54	1A	-	26	46																										
13	55	1B	-	27	47																										
16	56	22	44	2A	-																										
17	57	23	45	2B	-																										
<p><b>3</b> Termination styles</p>	<p>(see KMC ordering information p. 43)</p>																														
<p><b>4</b> Mounting hardware</p>	<p><b>Guide Styles</b>                  (see p. 50 to 54) - (Consult us for special guides) - See KMC ordering information p. 43</p> <p><b>Locking Styles</b>                  (see p. 56-57) - See KMC ordering information p. 43</p>																														

\* For 90° & straight terminations (splicing on PCB)  
 \*\* RoHS conform for 90° & straight terminations (splicing on PCB)

# Layout

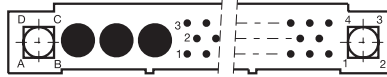

No. of fixings	KMH layout	No. of special contact cavities	No. of signal contacts
2	326	3	26
2	344	3	44
2	380	3	80
3	390	3	90

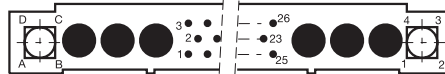

KMH layout	No. of special contact cavities	No. of signal contacts	KMH layout equivalent dimensions
			044
626	6	26	062
			098
			108

# Dimensions

## 26 to 80 Signal Contacts & 3 Special contact cavities

One part plug  
(molding A) only KMH 380

Two parts plug & receptacle  
(molding B) KMH 326, 344, 380

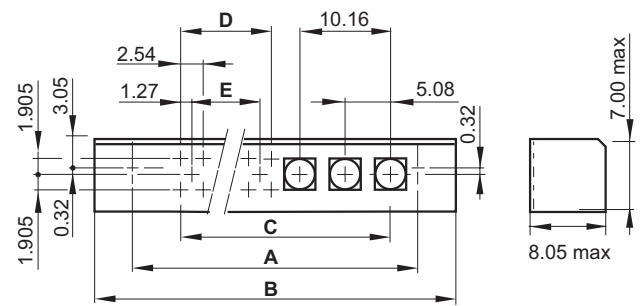
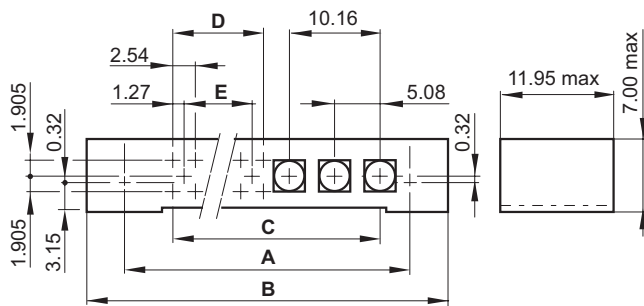

## 90 Signal Contacts & 3 Special contact cavities

Two parts plug & receptacle (molding B) KMH 390

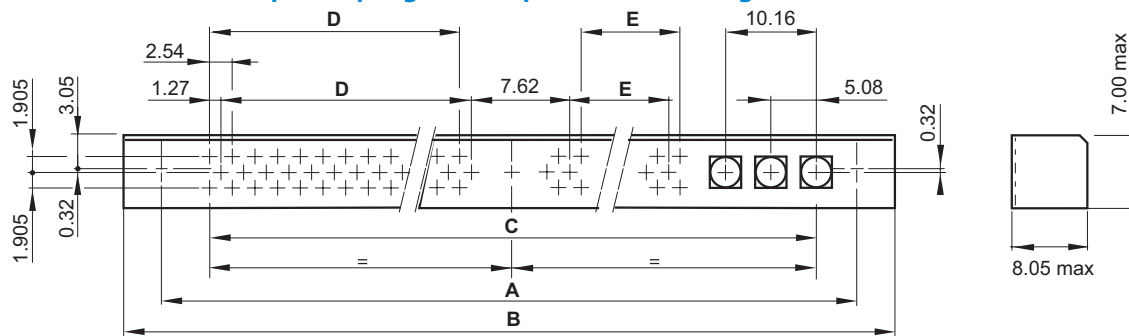

KMH layout	A	B max	C	D	E	KMH layout equivalent dimensions
326	45.72	53.70	35.56	20.32	17.78	044
344	60.96	69.00	50.80	35.56	33.02	062
380	91.44	99.50	81.28	66.04	63.50	098
390	106.68	114.70	96.52	43.18	27.94	108

## 26 Signal Contacts & 6 Special contact cavities

Two parts plug & receptacle (molding B) with special contact cavities on both extremities KMH 626

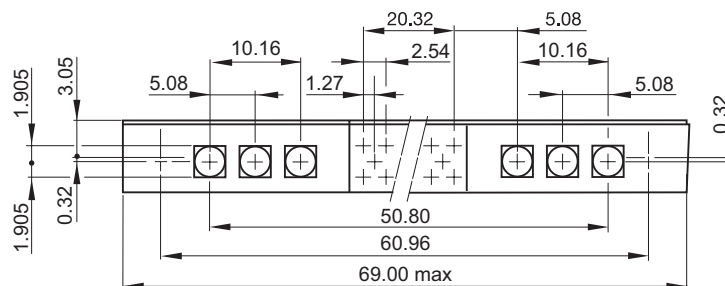

# Power & High Frequency Contacts

(NF C-UTE C 93-569)

## Example of contact overview (020 084 2- 10 RN1)

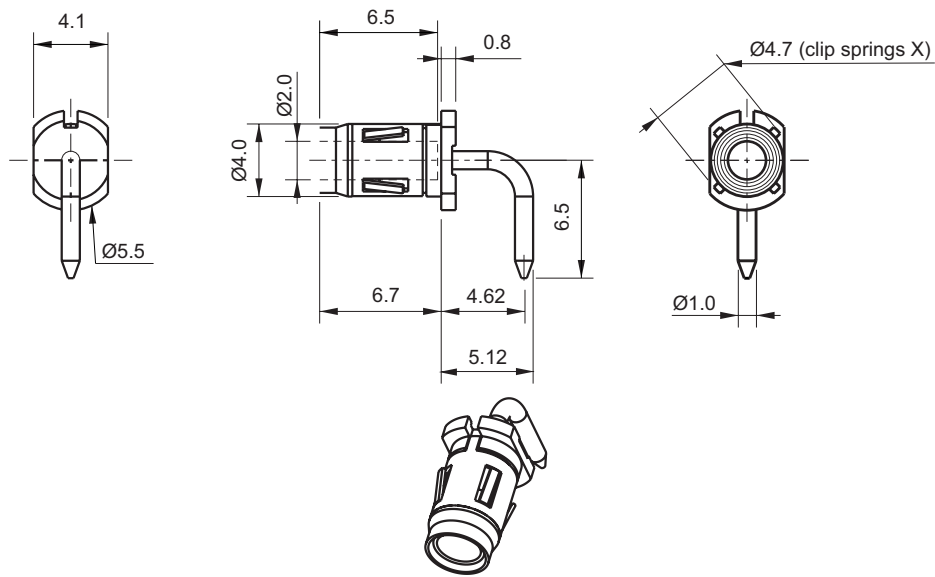

Male		Female	
	P/N		P/N
90° termination	020 085 1- 10R OG	90° termination	020 084 2- 10R G1
Straight termination	020 087 1- 30R OG	Straight termination	020 056 2- 30R G1
Solder bucket termination	020 091 1- 40R OG	Solder bucket termination	020 060 2- 40R G1

# Tools and Accessories

## Screwdrivers

Reference	Use	Pinning			Remark
S_____028	- Connector fitted with female guides - "B" molding - Cover's fixing screw for female guide	144	to	162	These three screwdrivers can be delivered in a same packing under the reference S_____036
S_____029	- Connector fitted with male guides - "B" molding - Cover's fixing screw for female guide and screw central fixing on wiring side	144	to	162	
S_____033	- "B" molding - Cover's fixing screws	026	to	162	

## Special contact extraction tool

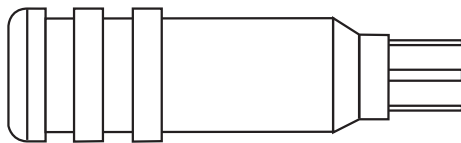

SD.030 00 CX 003

## Pin protector

Reference	Use	Guide style
KMC..._____302* ↙ Pinning	KMC... 13..110-KMC...23..111 KMC ... 13..111	Polarized male guide
KMC..._____303* ↙ Pinning	KMC... 13..125	Unpolarized male guide
KMC..._____304* ↙ Pinning	KMC... 23..153	Unpolarized female guide
KMC..._____305* ↙ Pinning	KMC... 23..121 KMC... 23..154	Polarized female guide

**Note:** these 4 references are not available for the 162 contacts version  
 • Antistatic material

## Disclaimer

All of the information included in this catalogue is believed to be accurate at the time of printing. It is recommended, however, that users should independently evaluate the suitability of each product for their intended application and be sure that each product is properly installed, used and maintained to achieve desired results.

Smiths Interconnect makes no warranties as to the accuracy or completeness of the information, and disclaims any liability regarding its use.

Smiths Interconnect reserves the right to modify design and specifications, in order to improve quality, keep pace with technological development or meet specific production requirements.

No reproduction or use without express permission of editorial and pictorial content, in any manner.

# Product Portfolio

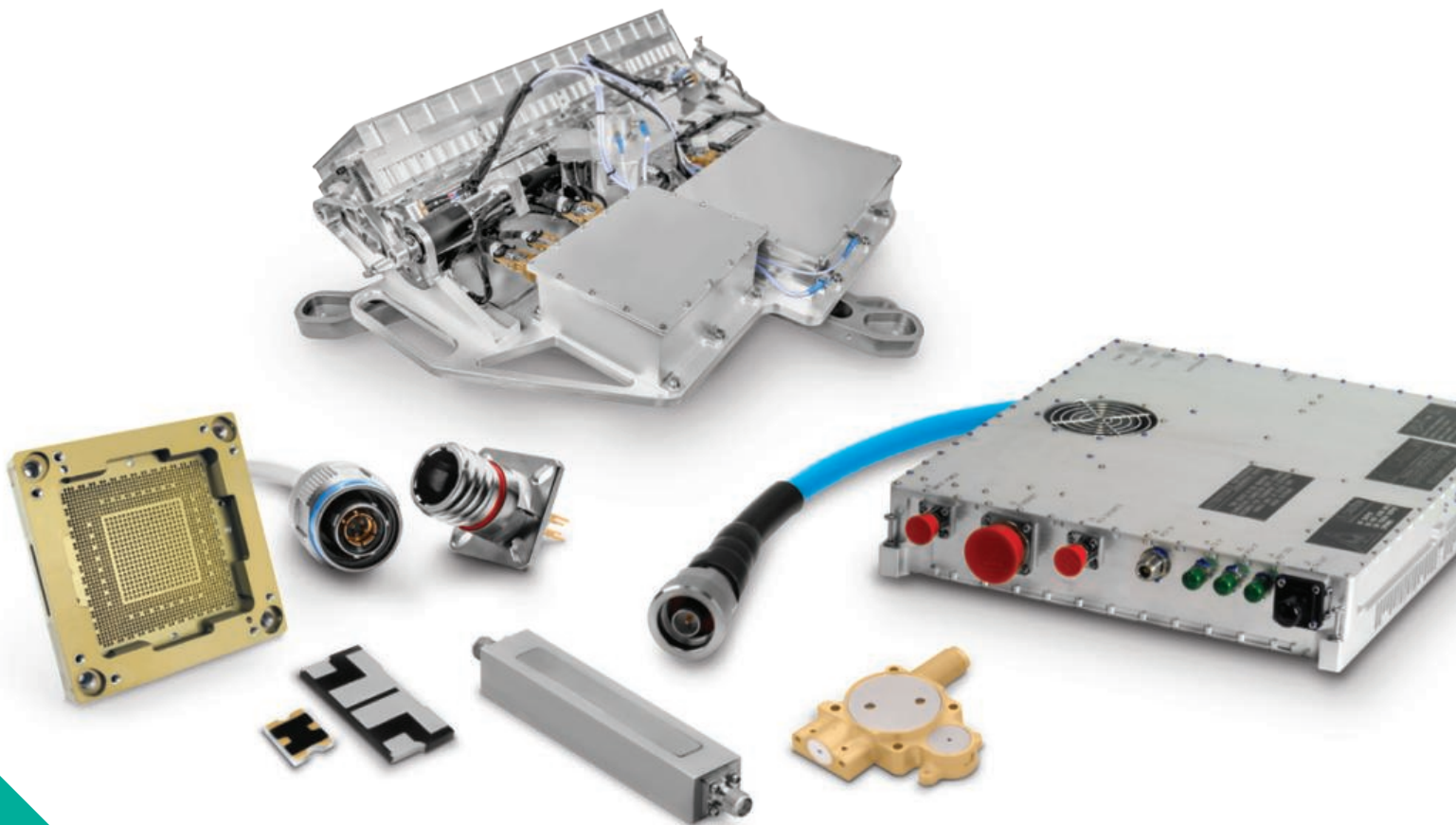

- Antenna Systems
  - Cable Assemblies
  - Connector Solutions
  - Ferrite Components & Assemblies
    - RF Filter Components & Assemblies
    - Integrated Microwave Assemblies
    - Millimeter-Wave Solutions
    - RF Components
      - Test Sockets and WLCSP Probe Heads
      - Time & Frequency Systems

# Worldwide Support

---

## Connectors

### Americas

#### Sales

connectors.uscsr@smithsinterconnect.com

#### Technical Support

connectors.ustechsupport@smithsinterconnect.com

### Europe

#### Sales

connectors.emeacsr@smithsinterconnect.com

#### Technical Support

connectors.emeatechsupport@smithsinterconnect.com

### Asia

#### Sales

asiacsr@smithsinterconnect.com

#### Technical Support

asiatechsupport@smithsinterconnect.com

---

## Fiber Optics & RF Components

### Americas

#### Sales

focom.uscsr@smithsinterconnect.com

#### Technical Support

focom.techsupport@smithsinterconnect.com

### Europe

#### Sales

focom.emeacsr@smithsinterconnect.com

#### Technical Support

focom.techsupport@smithsinterconnect.com

### Asia

#### Sales

focom.asiacsr@smithsinterconnect.com

#### Technical Support

focom.techsupport@smithsinterconnect.com

---

## Semiconductor Test

### Americas

#### Sales

semi.uscsr@smithsinterconnect.com

#### Technical Support

semi.techsupport@smithsinterconnect.com

### Europe

#### Sales

semi.emeacsr@smithsinterconnect.com

#### Technical Support

semi.techsupport@smithsinterconnect.com

### Asia

#### Sales

semi.asiacsr@smithsinterconnect.com

#### Technical Support

semi.techsupport@smithsinterconnect.com

---

## RF/MW Subsystems

### Americas, Europe & Asia

#### Sales

subsystems.csr@smithsinterconnect.com

#### Technical Support

subsystems.techsupport@smithsinterconnect.com

# Connecting Global Markets

smithsinterconnect.com |    

Copyright© 2024 Smiths Interconnect | All rights reserved | Version 1.7

The information contained within this document is subject at all times to applicable Export Control regulations and legal requirements.