

Assembly Instructions

REP Series

Environmentally - Sealed Rectangular Plastic Connectors

Hypertac S.A. – January 2014



Table of Contents

I. Introduction

- A. Connectors & Contacts
- B. Tooling
- C. Data code reading
- D. Cavities marking

II. Cabling

- A. Crimping
- B. Contact insertion
- C. Contact extraction
- D. Coding

III. Accessories

- A. Cable ties
- B. Sealing plug
- C. Dummy contacts
- D. Heat-shrinkable tubing

IV. Panel Mounting

- A. REP 202, 606 & 612 Series
- B. REP 402, 406 & 412 Series

I. Introduction

A. Connectors and contacts

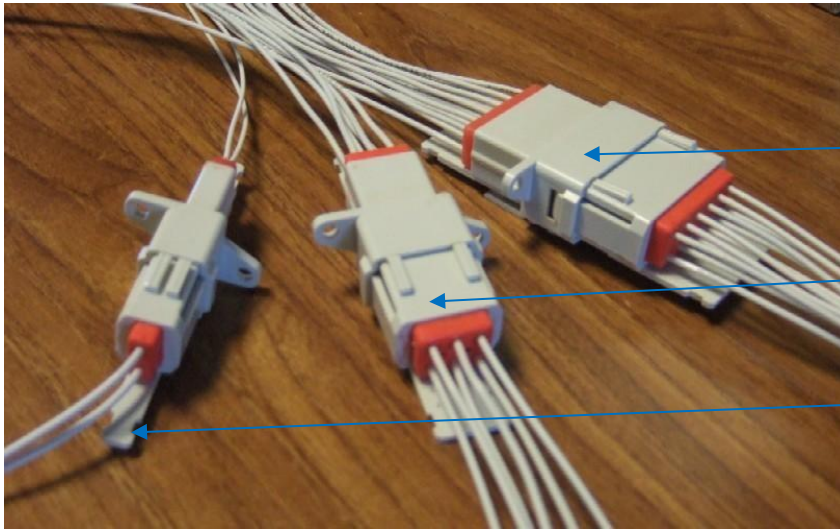

REP Series, 12 ways

REP Series, 6 ways

REP Series, 2 ways

REP Connector: Receptacle & Plug

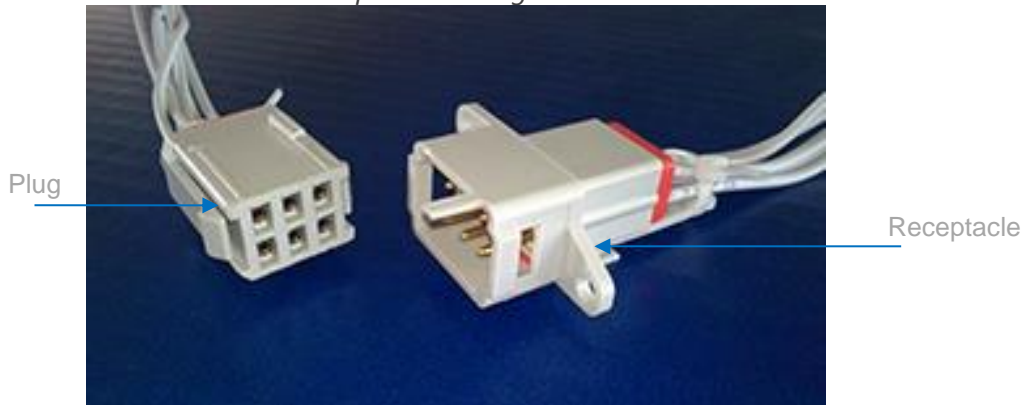

Plug

Receptacle

Hyperboloid Contact - Ø1.5mm (16)



Socket 0151832-20---

Pin 0151071-20---

REP Receptacle Connector for PCB

Connectors are delivered equipped with the contacts.

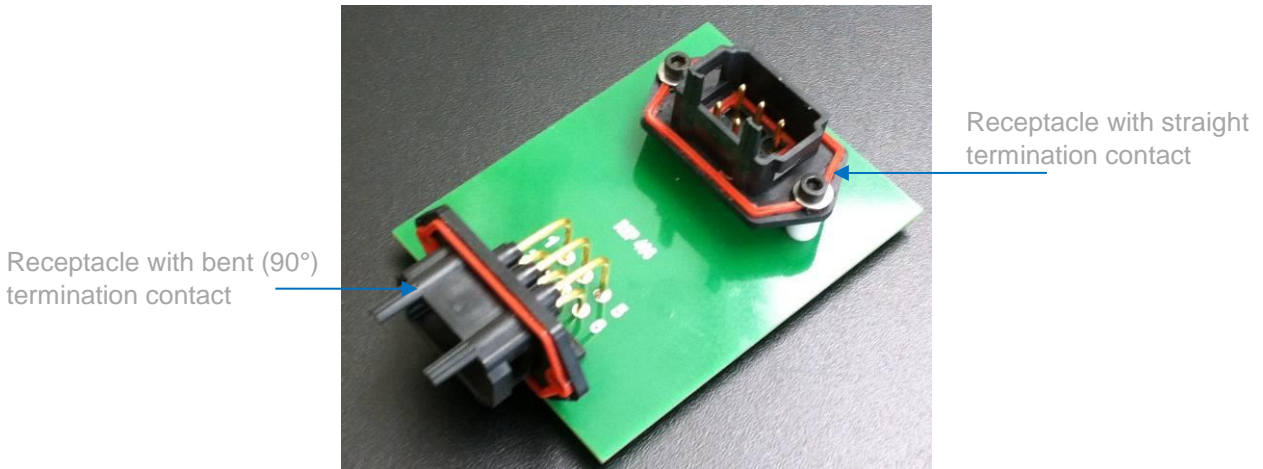

B. Tooling

Crimping tool



FT8 (Daniels) or TGV101 (Astro-tool)

Locator



SH463 or TGV 202

Extraction tool



SD-015000012

C. Data code reading

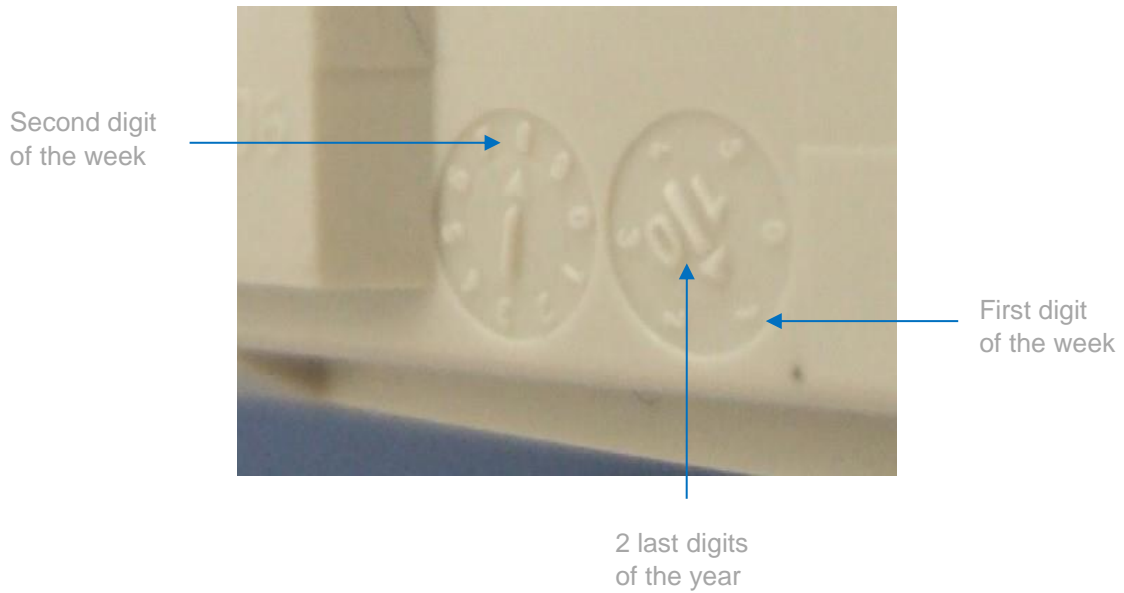

Example of the picture: week 18th of 2010

D. Cavities marking

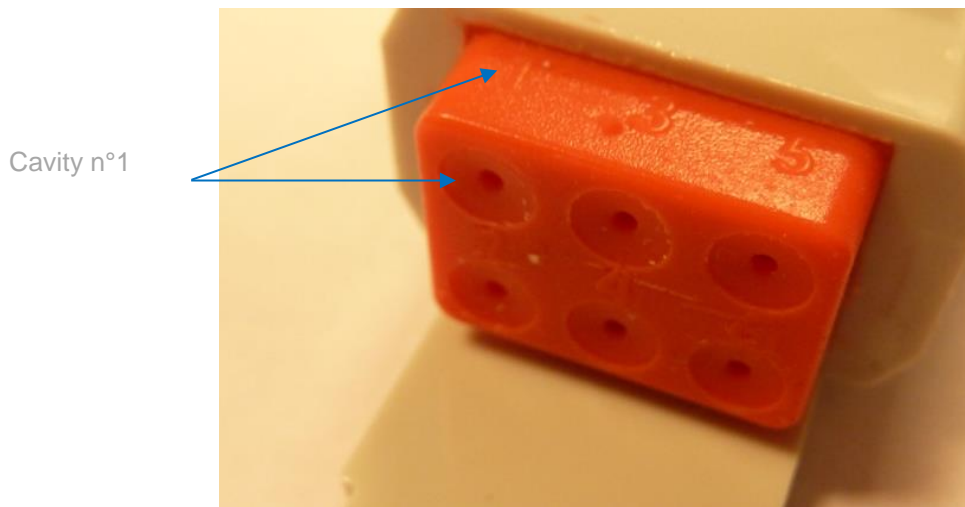

II. Cabling

A. Crimping

Stripping process of the cable

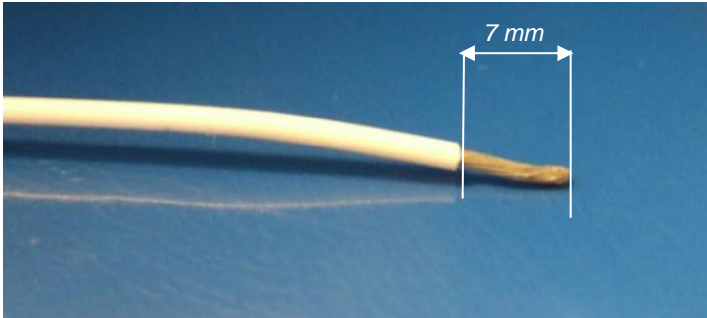

The cables must be stripped with a suitable tool for instance as shown by the picture below to avoid damaging the core and the insulating sheath. Strip the cable over 7mm corresponding to the drilling dimension of the contact cup.

Crimping process of the contact

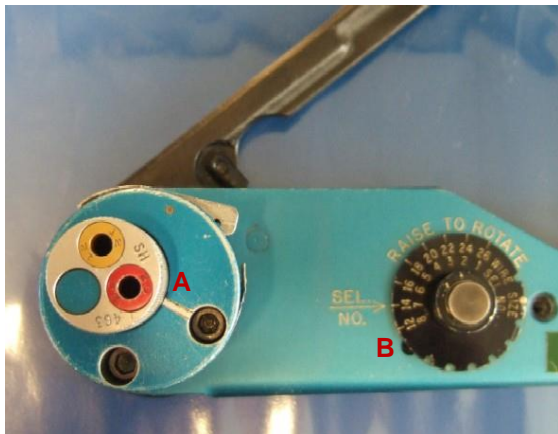

- A. Check the tool turrent position (red).
- B. Check the selector position



Insert the contact mating side (hyperboloid) in the locator

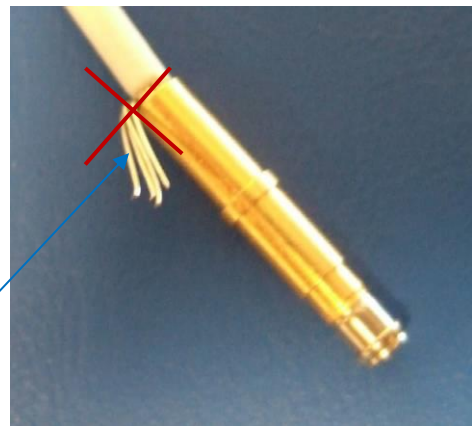

Check that any cable wire stalk left outside (to avoid damaging the silicone)

Crimping tools			
Contact	Crimping tool	Tool turret	Selector position and wire cross section (EN50306 – NFF63808)
0151071-20--- 0151832-20---	Astro-tool TGV 101	TGV 202 Red	5 - 0.5mm ² to 1mm ² (AWG20-18) 6 - 1.34mm ² to 1.82mm ² (AWG16-14) 7 - 1.91mm ² to 2.61mm ² (AWG14)
	Daniels FT8	SH 463 Red	

B. Contact insertion

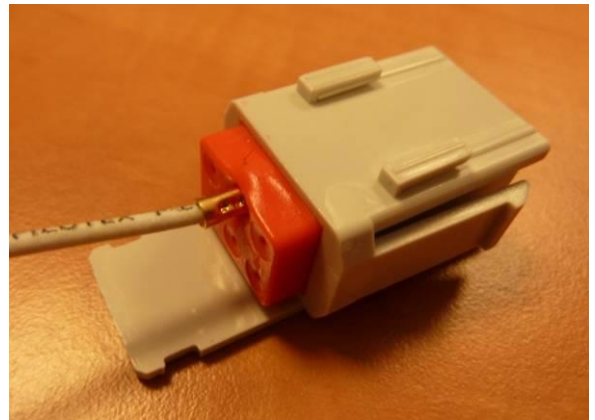
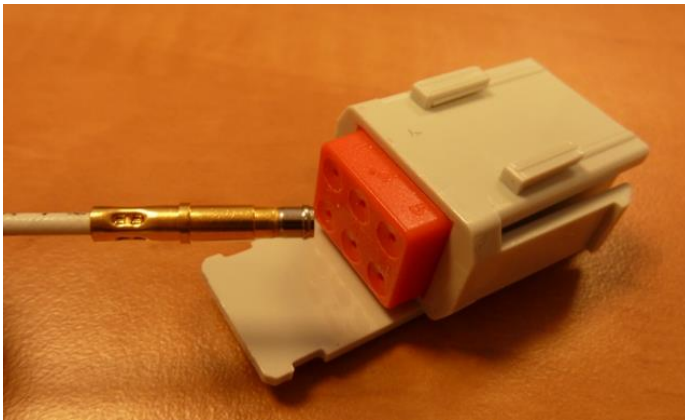

Hold connector with rear grommet facing you.
Push contact straight into connector grommet until a click is felt.
A slight tug will confirm that the contact is properly locked in place.

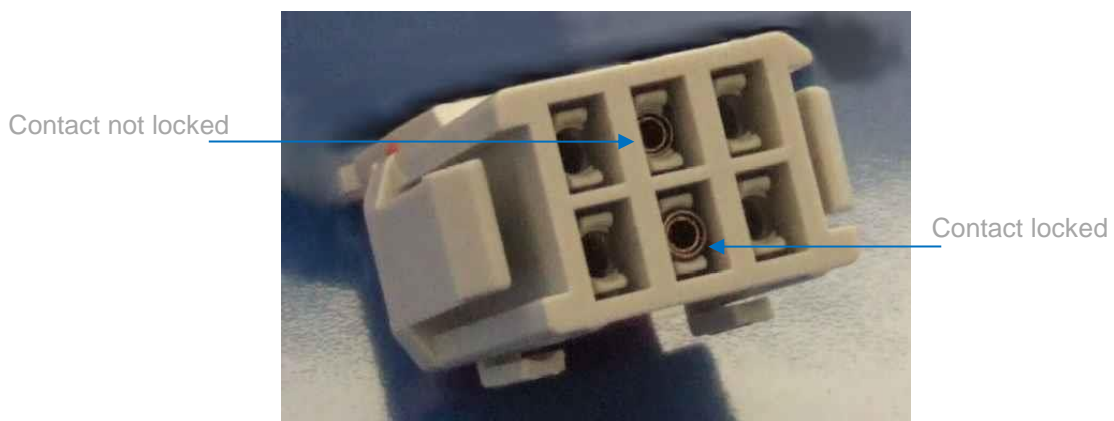

C. Contact Extraction

Hold connector with mating side facing you. Remove the contact with the tool SD-015000012 (see picture)

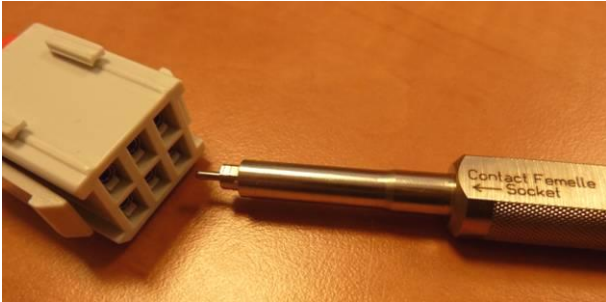

Socket contact extraction process



Pin contact extraction process

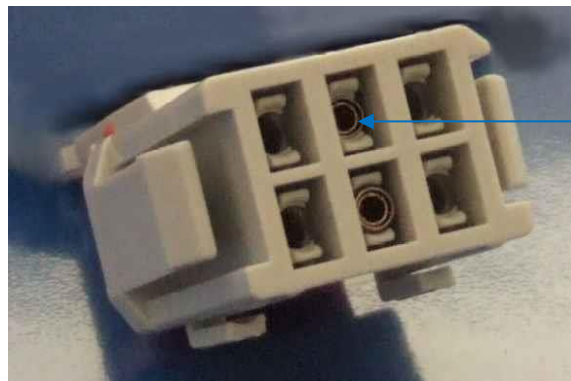

Contact unlocked

D. Coding

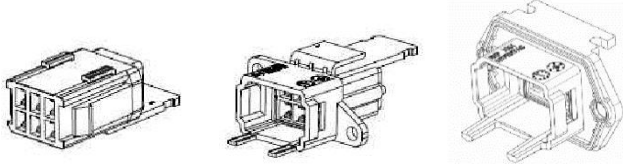

.Not coded version

Connectors are delivered without any coding.

3 codings are possible without any additional part.

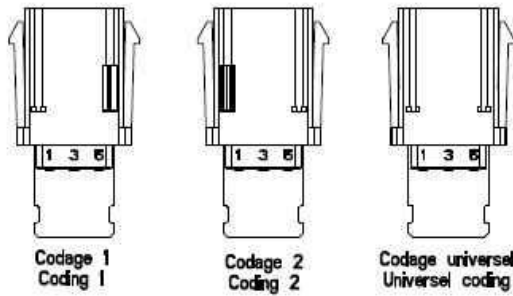

Plug

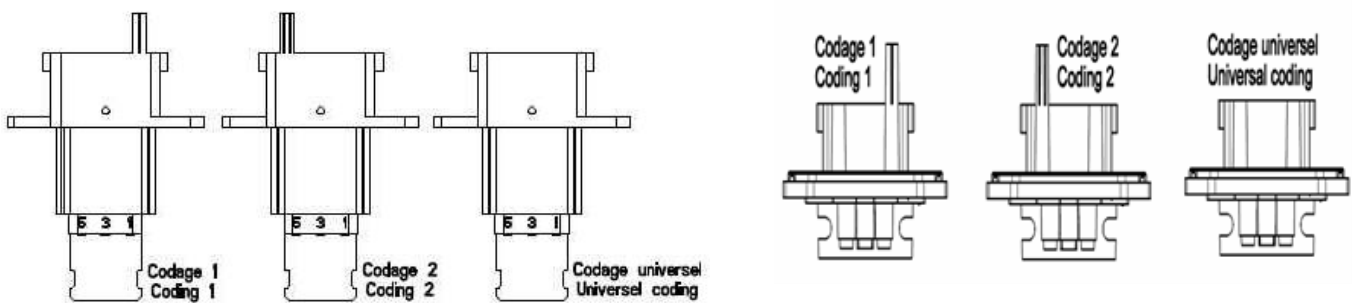

Receptacle

III. Accessories

A. Cable ties (i.e Tyrap)

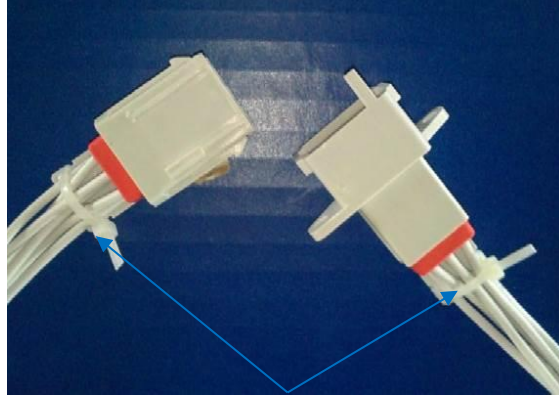

Slots for cable ties.

For reminder, the cables ties are not supplied with the connectors.

B. Sealing Plug (REP_001)

When the connector is not fully equipped with contacts and to ensure the IP66 sealing, the cavities do not have to stay empty. The sealing plug REP_001 is then equipped in the connector

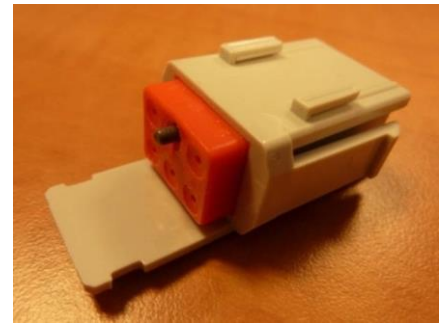
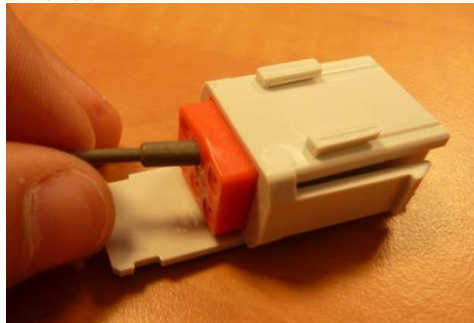

Hold the connector with the rear grommet facing you and push the plug in the empty cavity.

C. Male and female plastic dummy contact (REP_002)

For >400V application use, the dummy contact must be used. The plastic dummy contact increases the creepage distance and ensures the IP66 rating protection.



Plastic dummy contact,
male or female

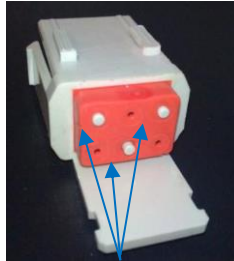

IP66 sealing ensured



Warning: the plastic dummy can not be removed, once inserted

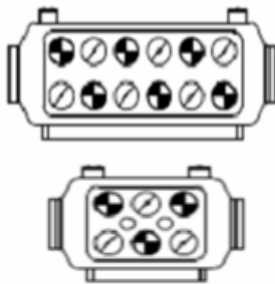

Contact arrangement view
from termination side



Working contact 015 183 2-20



Plastic dummy contact REP_002

- Volting rating: 400V according to EN50124-1, pollution degree 3
- Creepage distance: 7.73mm
- For > 230V (400V) application use, please use a cable according to EN50264-2-1

D. Heat-shrinkable tubing constituted cable

Minimum cable diameter for the heat-shrinkable tubing

- REP-02 - 4mm
- REP-06 - 6mm
- REP-12 - 13mm

If the diameter of the cable is not enough important, it is possible to extend the cable with another thermo-shrinkable tube. It is also possible to remove the back strip to allow a better retractability of the thermo-shrink tube. To remove this strip, you can use a cutter.

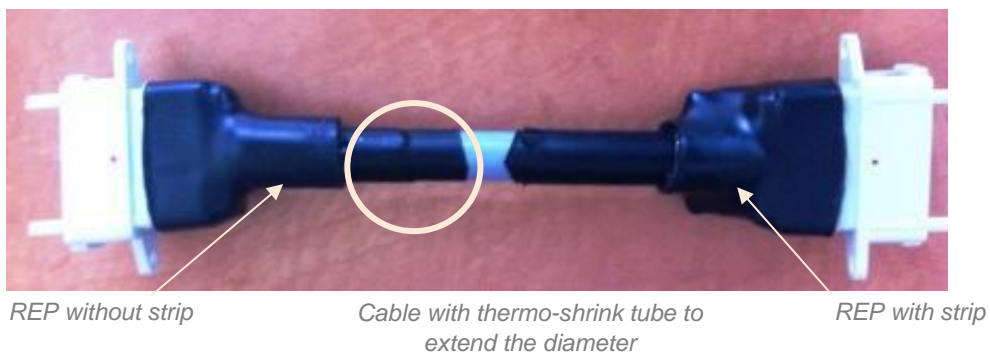

1. Strip the cable



Strip the cable on 50mm to allow the tube covering the cable

2. Insert the contacts: pins and sockets

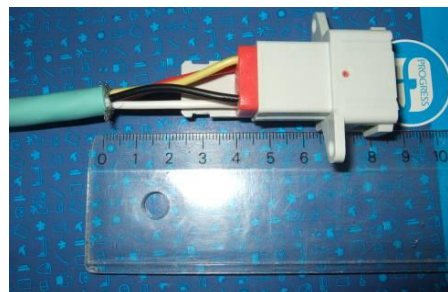
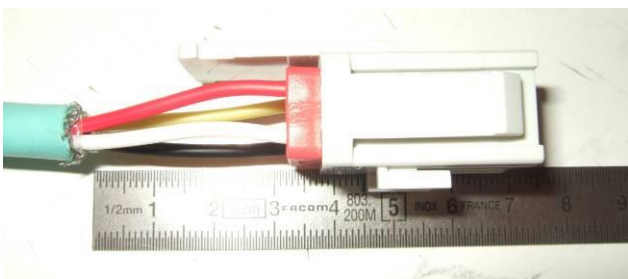

3. Cutting the tube

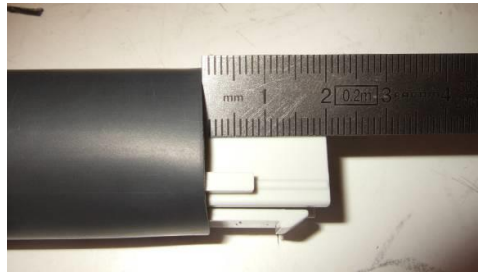
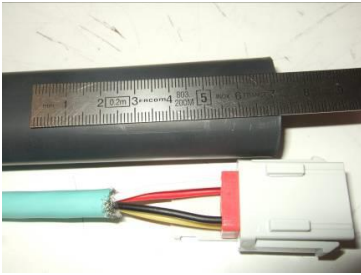

Cut the tube on 70mm and place it as described in the pictures.

4. Shrinking



With a hot air gun, shrink the tube.



Note: Start with the part covering the connector and then end with the one with the cable.

The temperature maximum of the shrinking is 110°C. If the temperature is higher, the connector will be damaged

IV. Panel Mounting

A. REP 202, 606 & 612

1. Cross mount

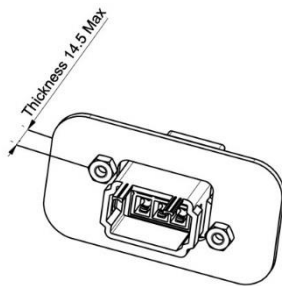

Front face

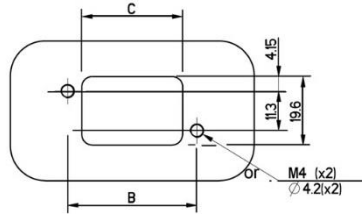

Back panel mount

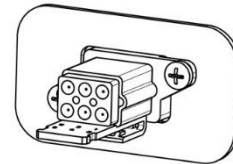

Rear face

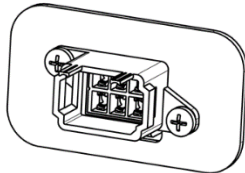

Front face

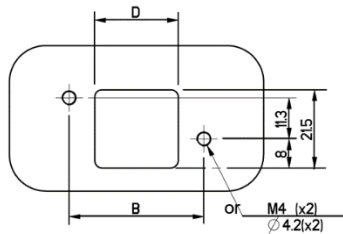

Front panel mount

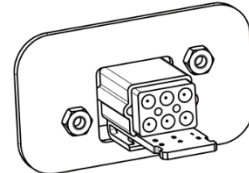

Rear face

2. Mount with the bracket REP_003

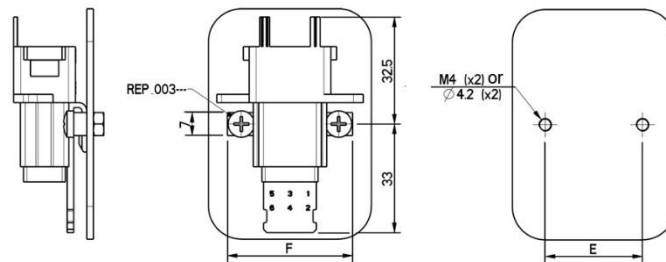

The screw must be fixed with a maximum of 60N.cm and fixed with the right precaution to avoid a release (i.e. threadlocker, elastic screw, unlocked screw, ...)

REP 2--	B	C	D	E	F
REP 202	26.1	18	12	18.7	27.2
REP 206	37.1	29	23	29.7	38.2
REP 212	53.6	45.5	39.5	46.2	54.7

B. REP 402, 406 & 412

1. Cross mount

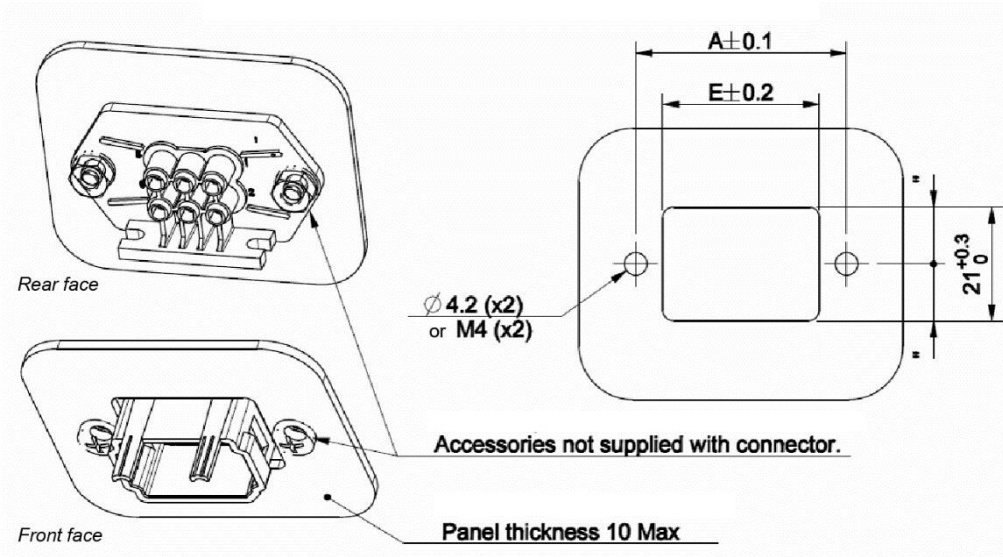

Back panel mount

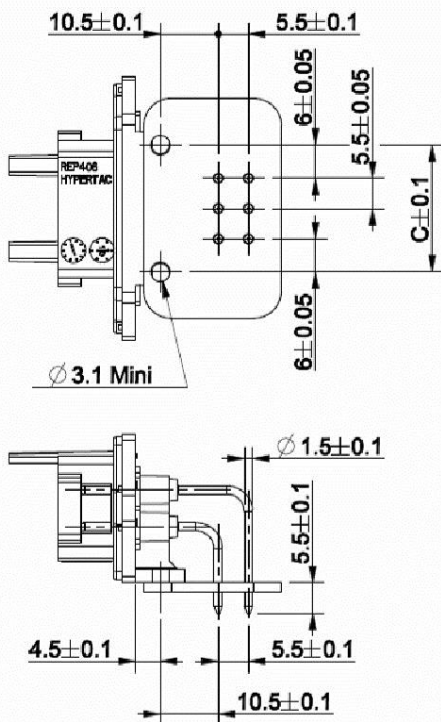

REP 4-	A	C	E
REP 402	28	12	18
REP 406	39	23	29
REP 412	55.5	39.5	45.5

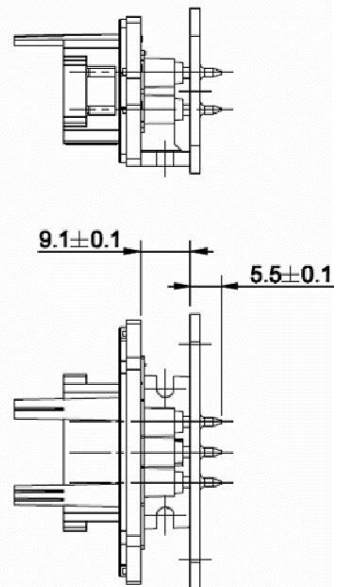
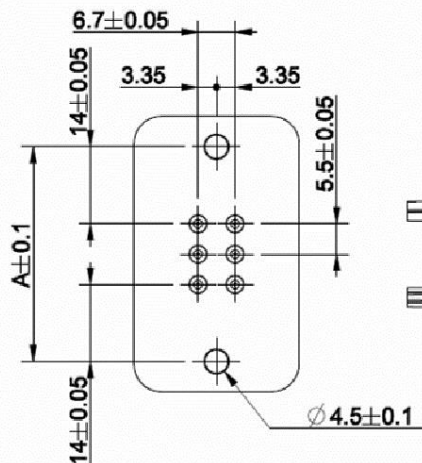

Contacts with a 90° termination. Cutting circuit board.

Contacts with a straight termination. Cutting circuit board.



The screw must be fixed with a maximum of 60N.cm and fixed with the right precaution to avoid a release (i.e. threadlocker, elastic screw, unlocked screw, ...)

2. Sealing

The accessories are not supplied with the connector, the user must provide a sealing at the screws/nuts with the sealing rings.

a) Position of the connector to optimize the sealing

90° position

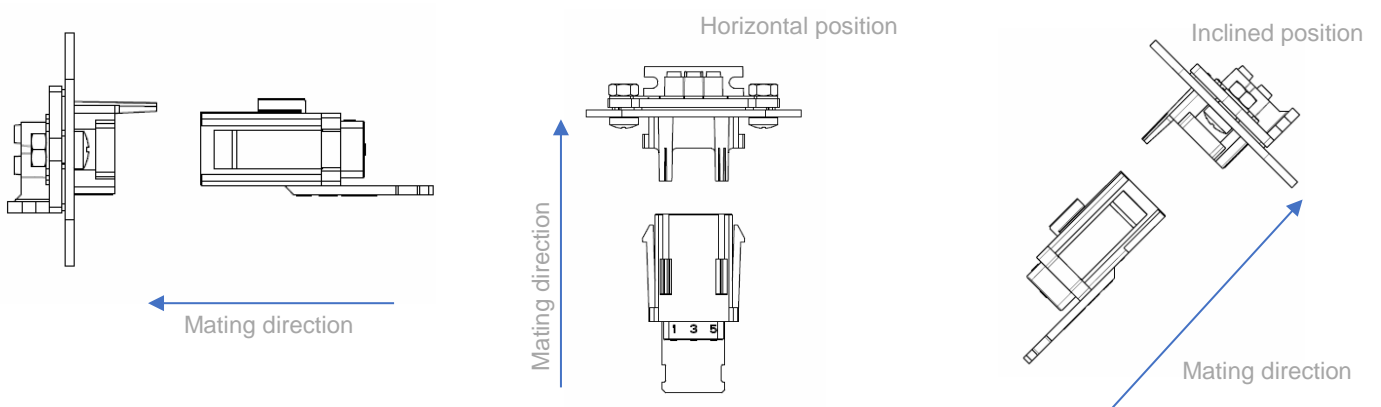

b) Connector with a vertical position

Inclined position

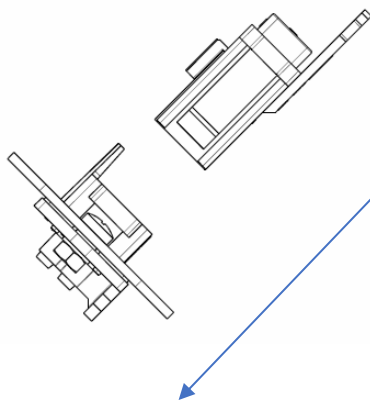

Mating direction

Horizontal position

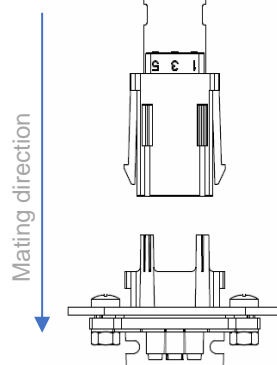

Check with caution that the connector is dry before insertion: risk of the presence of water in wet environment.